

CORE  COMMAND

BIG NASTY ALIENS



DREAM POD 9

CORE  COMMAND

BIG NASTY ALIENS



DREAM POD 9

Credits
CORE Command Concepts

Dream Pod 9 team

Writing

Marc A. Vézina, Senior Editor

Stuart Elle, Contributor

Chris Upchurch, Contributor

Scott Lette, Contributor

Colin Dunn, Contributor

Nicholas Pilon, Contributor

Chris Slee, Contributor

Paul Lippincott, Contributor

John Nuygen, Contributor

Ben Strong, Copy Editor/Additional Writing

 Thomas Chevrier-Laliberté, Copy Editor/
Additional Writing

Dream Pod 9 Team, Contributors

Art Direction

Pierre Ouellette

Layout

Pierre Ouellette

Jean-Francois Fortier

Cover and Interior Art

Patrick Boutin-Gagné

Coloration & Computer Art

 Marc Ouellette, Jean-Francois Major, Jean-
Francois Fortier

Marketing and Administration

Robert Dubois

Silhouette Rules

Gene Marcil, System Designer

Stephane I. Matis, System Designer

Marc A. Vézina, System Developer

CHAPTER 1: LIFE IN THE GALAXIES 4

Introduction 5

Book Contents 5

Sidebar: Game Stats 6

Sidebar: Alternate Sources 6

Natural Powers and Abilities 6

CHAPTER 2: SENTIENT RACES 12

Introduction 13

Aracknati 14

Hiscan 16

Zee 18

Bando 20

Tansol 22

Aki 24

Centar 26

Nep'ta'le 28

CHAPTER 3: FLORA AND FAUNA 32

Albitoi Swarm 33

Bloodworm Tree 34

Dargesh 36

Drifters and Streamers 38

Fluidion 40

Spectral Inha'azalass 42

GolGoChans 44

Gornan 46

Jirugui 48

Junko 50

Khorai Wolf 52

Mnemonic Keeper 54

Sanoth 5736 56

Silverspine 58

Tra 60

Keepichai 61

CHAPTER 4: CONSTRUCTS 62

Mechanical Beings 63

Animators 64

Kloopterra 65

Graviton Spheres 66

 Warden 67

 Sentinel 68

 Guardian 69

SE-224 Ki-3 Nanovirus 70

D'vor Destroyer 74

D'vor Brooder 76

D'vor Stellar Devourer 78

CHAPTER 5: EQUIPMENT 84

Tools of the Trade 85

 Kabayan Technology 85

 Grob Technology 85

 Other Races 85

Aracknati Rail Rifles 86

Grob Blasterguns 87

Grob Gunblades 88

Grob Heavy Weapons 89

Hisscan Missile Launchers 90

Kabayan Flaming Lances 91

Kabayan Halberds 92

Kabayan MonoSpears 93

Hisscan Dancing-Swords 94

Kom'Sov Combat Gauntlets 95

APPENDIX 96

 Open Gaming License 96

Credits

Produced and Published by

Dream Pod 9

5000 Iberville, Suite 332

Montreal, Quebec,

Canada, H2H 2S6



All art and design ©2003 Dream Pod 9, Inc.

The Dream Pod 9 logo, CORE Command, Silhouette CORE, and all other names, logos and specific setting terms are ©Dream Pod 9, Inc. All Rights Reserved.

CORE Command, Big Nasty Aliens, Silhouette CORE and all other proper names and logos are trademarks of Dream Pod 9, Inc.

'd20 System' and the 'd20 System' logo are trademarks of Wizards of the Coast, Inc., a subsidiary of Hasbro, Inc., and are used according to the terms of the d20 System License version 1.0. A copy of this License can be found at www.wizards.com/d20.

Wizards of the Coast® is a registered trademark of Wizards of the Coast, Inc., a subsidiary of Hasbro, Inc., and is used with permission.

No part of this book may be reproduced without written permission from the publisher, except for short excerpts for review purposes or use of Open Gaming Content consistent with the OGL. Any similarities to characters, situations, institutions, corporations, etc. (without satirical intent) are strictly coincidental. The various use of the genders throughout this manual should in no way imply the exclusion of one or the other, or suggest that the game is intended exclusively for a male or female audience.

Warning! Big Nasty Aliens is a work of fiction intended to be used in a game context only. It contains elements which may be deemed inappropriate for younger readers. Dream Pod 9, Inc. does not condone or encourage the use of violence or weapons. Parental discretion is advised.

Dream Pod 9 can also be reached through the internet. Check the rec.games.frp.misc conference for support and information about the DP9 games. You can also visit our World Wide Web page for additional support and free updates at <http://www.dp9.com/>.

Designation of Product Identity: The various Silhouette CORE rules and all CORE Command setting-related names, terms and artwork are considered Product Identity and are not Open Game Content. Nothing in this book except for material placed in stats blocks and sidebars features Open Gaming Content.

Designation of Open Game Content: Subject to the Product Identity above, the various d20-based monster stats, and equipment rules and stats, are considered Open Gaming Content and are hereby released under the Open Gaming License. If so used, they should bear the COPYRIGHT NOTICE "CORE Command: Big Nasty Aliens, Copyright 2003, Dream Pod 9, Inc." Some of the portion of this book which are delineated OGC originate from the System Reference Document and are ©1999, 2000 Wizards of the Coast, Inc.

Stock #DP9-904

Legal Deposit: August 2003

Bibliothèque Nationale du Québec

National Library of Canada

ISBN 1-894814-87-8

Printed in Canada

First Printing

Government of Québec — tax credit for book publishing — administered by SODEC

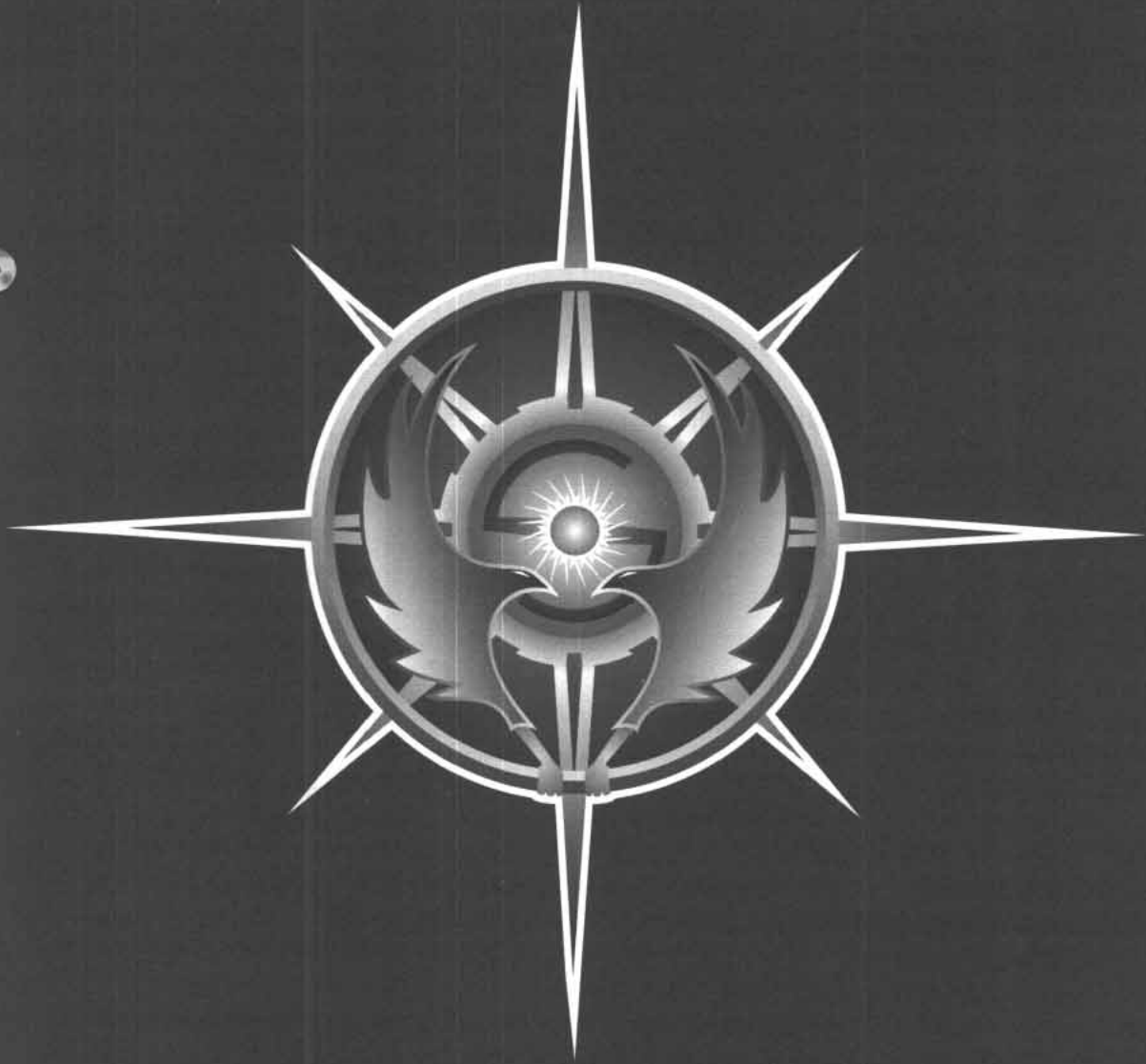

CHAPTER 1:
Life in the Five Galaxies



CHAPTER ONE: LIFE IN THE GALAXIES

CHAPTER 1

• Introduction

Wherever it might be, nature will find a way. The Five Galaxies are positively teeming with life, from the extremely harsh, star-packed environment of the galactic cores all the way to the frigid and lonely island-worlds of the galactic fringes.

Most of it is composed of fairly simple creatures, often down at the microscopic level. These can be found on virtually any world that offers even a glimmer of food (in any of its many forms, including gentle solar rays and complex organic molecules) and protection from harsh elements (though organisms have been found in near vacuum). The next step up, complex multi-cellular — or equivalent — structures are also common, but remain fairly simple overall: algae, plants, etc.

In about ten percent of all the galactic worlds, however, one can find multiple alien creatures. Most of them are non-threatening to any well-equipped civilized being, and in fact will generally tend to avoid (if they are mobile) any unfamiliar sight, such as an explorer team. Only a fraction of the fauna and flora of the universe is dangerous by any measure of the word.

There are a number of exceptions, of course, the most obvious being the D'vor artifact creatures. They bridge the gap between organic and inorganic beings, the latter of which are generally encountered in the form of artifacts defending or maintaining the various Dreamstate worlds found across the galaxies.

• Book Contents

For ease of use, this book is divided into four chapters after this introduction. This introductory chapter examines some of the strange abilities encountered in creatures found across the Five Galaxies.

Chapter 2 covers some of the sentient races that inhabit the galaxies, but whose civilizations are not major players on the galactic scenes.

Many of them are allied, formally or informally, with CORE, but a significant portion remains independent or even hostile.

Chapter 3 covers some of the animals and plants that have been listed as posing a threat to explorers within various galactic catalogs. Many have been selected for inclusion because they are representatives of classes of creature that can be found across multiple worlds and galactic sectors (given comparable local conditions and biochemistry, evolution has been found to produce remarkably similar lifeforms).

Chapter 4 covers a number of artifacts and constructs that have been encountered by previous CORE teams during their exploration and travels. Again, they have been selected because they are often encountered (either directly or because a local artifact has similar capabilities) across the Five Galaxies.

Finally, Chapter 5 covers a number of weapons and tools used by alien races against CORE personnel. While they have been listed under the name of their primary users and manufacturers, they are also encountered elsewhere, thanks to either parallel development or simple arms trade.



• **Game Stats**

Some of the creatures have regular animal/monster stats, others are stated as vehicles; this depends on their inherent toughness. Animal-stated creatures are soft-skinned, no matter their size, and a determined human with a melee weapon or its fists could eventually hurt them. Vehicle-stated monsters are much tougher and ignore unarmed blows from soft creatures.

• **Alternative Sources**

This book is merely a sample showcase of the multitude of alien races, creatures and constructs that can be encountered in the Five Galaxies. Given the vastness of local space, it would be near impossible to make a comprehensive list of everything. Thankfully, a number of alternate sources are available for Gamemasters who need a wider cast to populate their adventures.

Animals and creatures from other Silhouette settings, whereas original or CORE editions, can be dropped "as is" within a CORE Command adventure. For example, both Heavy Gear and Tribe 8 feature a large ecology of strange and often dangerous beings that would not be out of place on any remote planet. Likewise, monsters, beings and creatures from any of the multitude of monster guides created under the Open Gaming License can be freely incorporated. The text of this first chapter explains how to convert their various supernatural abilities to a space opera setting.

• **Natural Powers and Abilities**

Some creatures possess a number of special abilities that make them interesting or more fearsome. Most of these abilities derive from the creature's body layout, biological processes, or both. Prudent explorers will want to familiarize themselves with this information beforehand.

Ability Reduction: The biochemistry of some creatures will adversely affect the life processes of other organisms nearby, such as their reaction speed or their strength. This can be caused by emitted spores or gases, or by induced radiation of some kind. The effect can be temporary (being maintained dynamically by the creature itself) or permanent (due to damage caused at the cellular level). In general, this ability has evolved to defend the creature against predators or to make it a better predator itself.

Temporary Ability Damage — This is the basic form of ability reduction. It's caused by damage at the cellular level, mainly blocked chemo-receptors. It disappears after a few hours of rest, which give the body a chance to recuperate.

SilCORE Effects: The targeted Attribute drops by 1, 2 if the damage was caused by an attack and the defense was Fumbled. The Attribute regains +1 point every 24 hours until it returns to its original level.

Permanent Ability Drain — This is similar to the previous entry, albeit the effect is much more powerful (but thankfully restricted to direct touch). In some cases, the creature siphons off some fluid during the attack and use them to regenerate its own body. This results in permanent cellular damage that needs to be healed by a full autodoc or a competent Quantek user.

SilCORE Effects: The targeted Attribute drops by 1 if the target is hit in melee. If the defense test is Fumbled, the Attribute drops by 2. The creature heals one Flesh Wound. If converting, each -2 modifier to a d20 ability score equals a -1 to the ability score's equivalent Attribute.

CHAPTER ONE: LIFE IN THE GALAXIES

CHAPTER 1

If a Fortitude save to resist is allowed, make a Health test versus the blow's Damage Multiplier; a success means the damage is avoided completely.

Blindsight: The creature is able to use nonvisual senses, such as sensitivity to vibrations, scent, acute hearing, echolocation or any combination thereof, to "see" the world around it. Invisibility and darkness are irrelevant within the range specified in the creature's description.

SilCORE Effects: Ignore combat modifiers for lighting levels. The creature cannot be blinded by bright lights, such as flash grenades and similar devices.

Breath Weapon: Some creatures are able to project fire, acid or some form of energy from their body. This is usually a side result of a very active biochemistry, and may involve poison gland-like organs that manufacture and eject the compound. A creature is immune to its own breath weapon and those of others of its kind unless noted otherwise.

SilCORE Effects: A breath weapon attack usually causes damage. It allows a Defense test modified by AGI to dodge the stream, versus a Threshold equal to half the Damage Multiplier of the attack (rounded up). If the test is successful, no damage is caused.

Constrict: Many creatures have tentacles or large arms and can crush a grappled opponent, dealing bludgeoning damage.

SilCORE Effects: After a successful grapple, the creature may deal additional damage as listed in its entry.

Damage Reduction: Some creatures are either extremely tough or are able to heal injuries very rapidly thanks to a supercharged metabolism. In general, fighting this requires either massive irradiation damage of some kind to cause breakdowns at the cellular level or outright vaporization of body tissues.

SilCORE Effects: The creature ignores any damage from blows and projectiles that doesn't kill it outright. It can only be affected by energy weapons.

Darkvision: Some creatures, especially those evolving on worlds deprived of light, have learned to see in total darkness. The process varies from extremely sensible eyes, able to take in single photons, to sighting apparatus based on radiated energy, sound, or smell. Unless so noted, this ability generally has a limited range (~20 meters).

SilCORE Effects: Ignore combat modifiers for lighting levels. Darkvision is black-and-white only, but is otherwise like normal light.



Energy Drain: Some creatures are able to metabolize the energy content — both stored chemical energy and general field power — that flows within the body of all living beings. This slows down the victim and makes them confused and tired, making them easier prey.

SilCORE Effects: With each successful melee hit, the target suffers a -1 modifier to all its actions in addition to any damage taken from the blow. If the defense test is fumbled, the modifier becomes -2 instead. The attacker can heal one Flesh Wound per successful attack (a Deep Wound counts as two Flesh Wounds). If Character Levels are used (see **Silhouette CORE Rules**, section 2.6.4), each two successful hits cancel one SilCORE character level. The character must receive medical attention within 24 hours; if not available, make a HEA test versus the attack's Damage Multiplier for each hit. If failed, the loss becomes permanent.

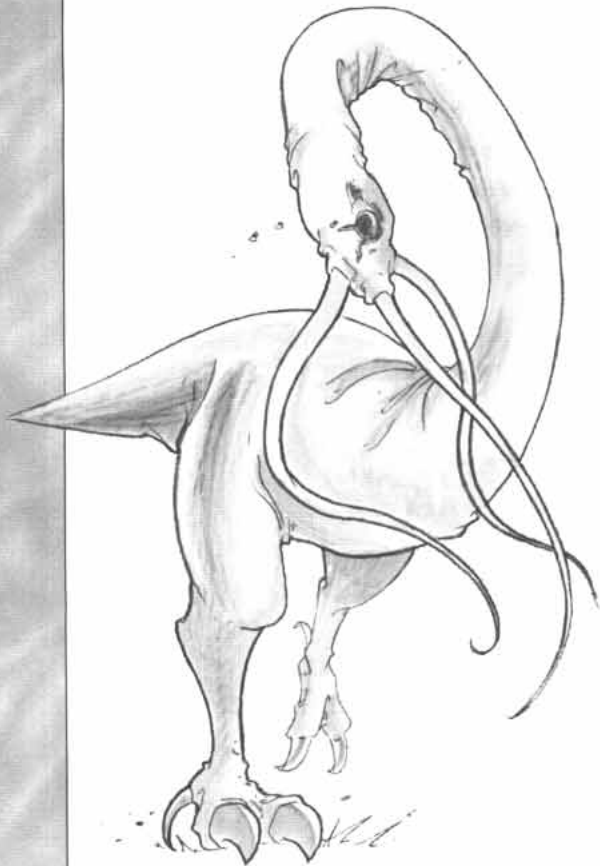

Fast Healing: The creature has an exceptionally efficient or fast metabolism. It's able to repair damage and regenerate small patches of missing tissues (but not whole limbs or organs) almost instantly. Fast healing is usually seen in creatures exposed to high levels of radiation, or those living in particularly violent environments. This is a cellular-scale ability, and rarely stops unless the creature as a whole is dead. It doesn't protect the creature against starvation, thirst or lack of air, however.

SilCORE Effects: The creature can heal one Flesh Wound every 1d6 minutes. It can heal one Deep Wound every 1d6 hours.

Fear Aura: Many creatures are exceptionally large or ferocious, and can strike fear into the heart of the most hardened explorers. Evolution has taken some organisms even further: either through released pheromones, modulated ultra-low frequency sounds or even physical appearance, they can activate the fear reflex (freeze or flee) in most living beings.

SilCORE Effects: The creature can control whether it causes fear or not as a free action. Any target must be within line of sight for this ability to work. Targets can attempt to resist by making an Opposed WIL test versus the creature's INS (or PSY). If failed, they either freeze in place or run in terror until they are out of sight of the fear-inducing creature (if running is not an option, they freeze in place instead).

Gaze: On a few worlds at the galactic fringes, evolution has taken a strange turn. Some of the local creatures have radiation emitters that can generate a number of physical effects ranging from paralysis to petrification (calcification of the tissues caused by venting liquids), if not outright death. For some creatures, direct visual contact is required; whether the usually thinner tissues on the face allow deeper penetration or the effect is actually triggered by the brain of the victim itself, no one knows. Fortunately for explorers, virtually all of these gaze effects require an unobstructed line of sight between the emitting organ (usually located around the head — or what passes for a head on the creature) and its target.

SilCORE Effects: There must be an unblocked line of sight between the creature and the target's eyes. The range of the attack varies, but is usually fairly short (BR 4 meters). If caught in the beam, the effects can be resisted by making a FIT test versus a Threshold equal to half the Damage Multiplier of the attack. All possible targets must make this test for every round of exposure to avoid the effect of the gaze. A creature is immune to its own gaze attack unless otherwise noted.

If some concealment is used, the target may avoid having to resist the effect. Partial soft cover or averting one's eyes gives a 1-3 chance on 1d6 to avoid the effect automatically. Full soft cover, or acting blind, cancels the effect completely. The creature, obviously, is considered to be in cover as well for return attacks.

Improved Grab: Some creatures have a physiognomy that allows them to capture targets of smaller size, presumably to attack them more effectively, immobilize them, or attempt to swallow them. This may be due to large manipulators, tentacles or other similar appendages.

SilCORE Effects: If the creature manages to hit in melee combat, it may immediately attempt a second action to grapple the target. This only work against opponents that are smaller than the creature. If the grapple is successful, no damage needs to be inflicted — the target may be simply held, which allows the creature to do something else. A held being doesn't suffer additional automatic damage unless the creature also has the constrict ability; to deal damage, the creature must use its normal melee attack(s).

Low-Light Vision: Many animals and sentient species have evolved the capacity to see with very little illumination, either by making their light receiving area larger or simply by being more sensible to photons.

SilCORE Effects: Reduce combat modifier penalties by 1 for lighting levels (never increasing above 0). A creature with low-light vision can see twice as far as normal in poor

lightning conditions. The creature can still distinguish colors, even under dim illumination.

Poison: A great number of animals and plants (and creatures that belong to both or neither of these classifications) have evolved some form of poisonous attack to hunt or protect themselves. Virulence of the compound depends on its intended use, and may range from mild (to dissuade attackers) to violent (to bring down prey). Most creatures are immune to their own poison, though there are rare exceptions.

SilCORE Effects: Treat as a lethal toxin of Onset Time one round and a Potency equal to the Damage Multiplier of the attack. Any other specific effects will be listed in the creature's description.

Power Resistance: Some creatures have evolved a set of resistance to mind-control and other reality altering effects, such as Quantek use. Since such an ability could hardly result from normal evolutionary processes, creatures with these abilities are highly sought by CORE and its scientists.

SilCORE Effects: A creature with power resistance can avoid the effects of Quantek, spell, psionic or similar powers that directly affect it. The attacker must test its ability against one quarter of the creature Power Resistance number (rounded up). If failed, the effects of the attack are negated.

Regeneration: The creature's metabolism functions at peak efficiency. Its supercharged cells not only ignore casual damage but can go into a frenzy of reproduction, repairing damage in an instant. The creature can even regrow lost limbs, given a few minutes. The only way to affect such a creature is to cause massive amounts of damage all at once to overwhelm its natural defenses. Most creatures able to regenerate also have a pronounced weakness that may be exploited, such as a vulnerability to fire, radiation or some chemical compound. This is a cellular ability, and rarely

stops unless the creature as a whole is dead. It doesn't protect the creature against starvation, thirst or lack of air, however.

SiICORE Effects: The creature ignores any blow, melee or ranged, that don't cause at least a Deep Wound, unless that blow correspond to the creature's vulnerability (in which case damage is applied normally). Any wounds suffered heal at a rate of one Deep Wound per 1d6 minutes. The exception to this is any wound caused through the creature's vulnerability, which do not regenerate and heal at the normal rate.

Regenerating creatures can regrow and reattach severed body parts. Severed parts that aren't reattached within 1d6 minutes wither and die normally. Regeneration continues to work no matter how many wounds the creature suffers, healing wounds from any damage other than from attack forms the creature is



specially vulnerable to. The only exception is damage that exceeds the creature's Overkill rating, which kills it outright.

Resistance to Energy: Some of the harshest environments in the universe still managed to produce some forms of life. To achieve this, evolution had to bestow some specific types of resistances to the local creatures. Some, living in acidic liquids, have a biochemistry that is completely immune to acids; others, living under permanent storms, have semi-conducting skeletal supports that literally ground them and make them immune to the lightning discharges that keep striking them.

SiICORE Effects: The creature ignores some damage of the given energy type (acid, cold, electricity, fire, or sonic/concussion) each time the creature is subjected to such damage. The creature's entry indicates the amount and type of damage ignored. If converting, the creature reduces the Damage Multiplier of any attack of the resisted type by a number equal to its d20 hit point resistance.

Scent: Virtually all creatures that have evolved within an atmosphere have developed a sense of smell. In some, it's highly pronounced, allowing them to spot opponents and prey over even long distances. Some species have even developed a form of speech based on complex scent molecules. This ability allows the creature to detect approaching enemies, sniff out hidden foes, and track by sense of smell. Creatures with the scent ability can identify familiar odors just as humans do familiar sights.

SiICORE Effects: The creature can detect opponents within 10 meters by sense of smell. If the opponent is upwind, the range increases to 20 meters; if downwind, it drops to 7 meters. Strong scents can be detected at twice the ranges noted above. Overpowering scents can be detected at triple normal range. When a creature detects a scent, the exact location is not revealed — only its presence somewhere within range. The creature can take an action to note the direction of the scent. If it moves within 2 meters of the source, the creature can pinpoint that source.



CHAPTER ONE: LIFE IN THE GALAXIES

CHAPTER 1

A creature with the scent ability can follow tracks by smell, making a Perception test to find or follow a track. The typical Threshold for a fresh trail is 4 (no matter what kind of surface holds the scent). This Threshold increases or decreases depending on the strength of the quarry's odor, the number of creatures being tracked, and the age of the trail. For each hour that the trail is cold, the Threshold increases by 1. Creatures tracking by scent ignore the effects of surface conditions and poor visibility.

Spell Resistance: See Power Resistance.

Spells: Some creatures or artifacts with built-in Quantek (or Quantek-like) capabilities have been discovered in the previous century. Like the power resistance feature, this ability is unlikely to have evolved naturally and may have been provoked by unknown parties for equally mysterious purposes.

SiICORE Effects: The creature can use Quantek effects as defined in the **CORE Command Player's Handbook**.

Swallow Whole: Some creatures are extremely large or are equipped with a large jaw that can take the whole prey in one bite.

SiICORE Effects: If the creature begins its turn with an opponent held in its mouth (see improved grab, above), it can attempt a new Hand-to-Hand test. If it succeeds, the creature swallows its opponent and deals bite damage (if any). Unless noted otherwise, the opponent

must be smaller than the swallowing creature by at least 2 points of BLD.

Being swallowed has various consequences depending on the creature, but a swallowed opponent is considered grappled, while the creature is not. A swallowed opponent can try to cut its way free with any light piercing or slashing weapon (the amount of cutting damage required to get free is noted in the creature's descriptive text), or it can just try to escape the grapple. If the swallowed opponent chooses the latter course, success puts it back in the creature's mouth, where it may be bitten or swallowed again.

Trample: Some large creatures will attempt to use their bulk to trample and crush their opponents.

SiICORE Effects: As an action during its turn each round, the creature can run over an opponent at least 2 BLD points smaller than itself. If its movement can reach, and the target isn't able to dodge out of the way, the trample deals bludgeoning damage, and the creature's descriptive text lists the amount.

Trampled opponents can attempt a free attack, but this incurs a -2 penalty. If they don't make a free attack, trampled opponents can attempt an Opposed FIT test versus the creature's STR; the Margin of Success of this test is subtracted from the attack's MoS before damage is calculated.

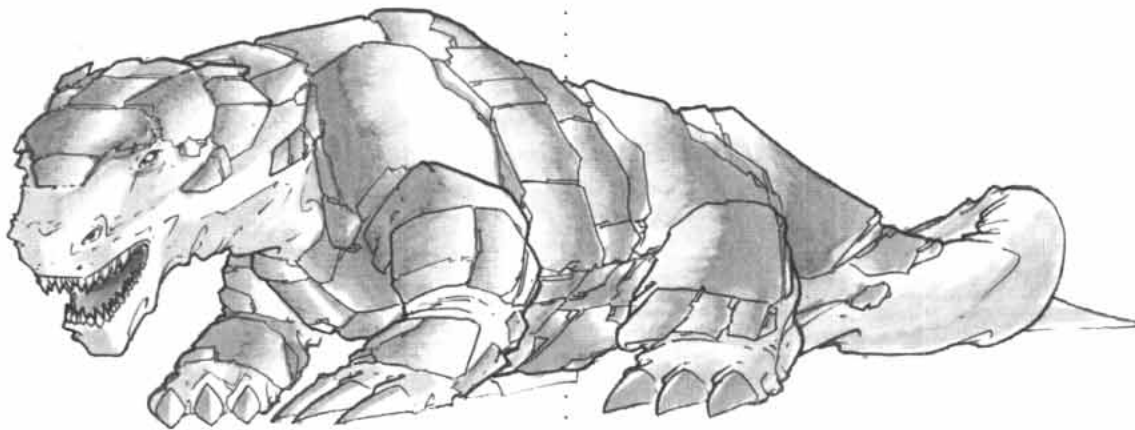

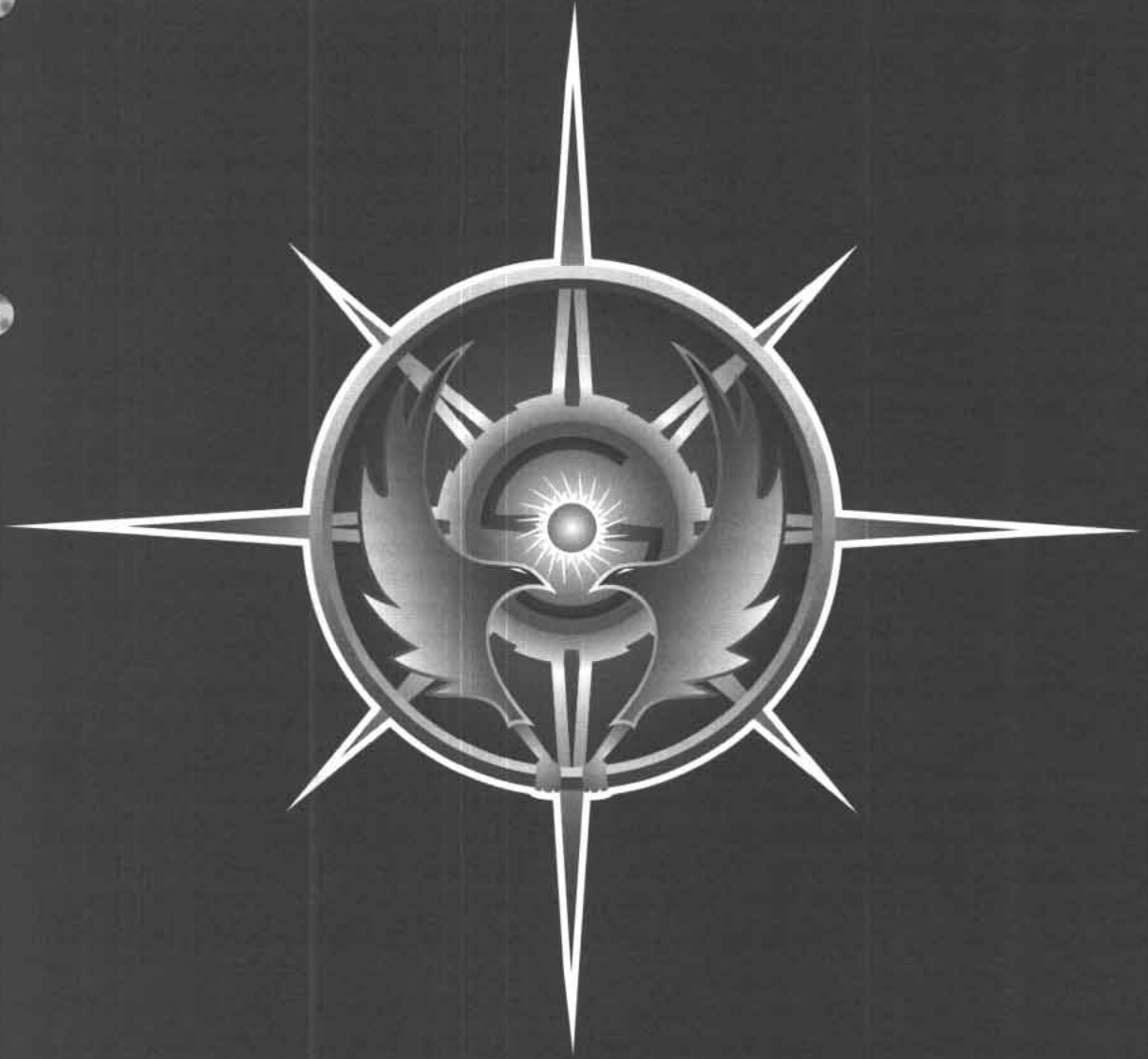

CHAPTER 2:
Sentient Races



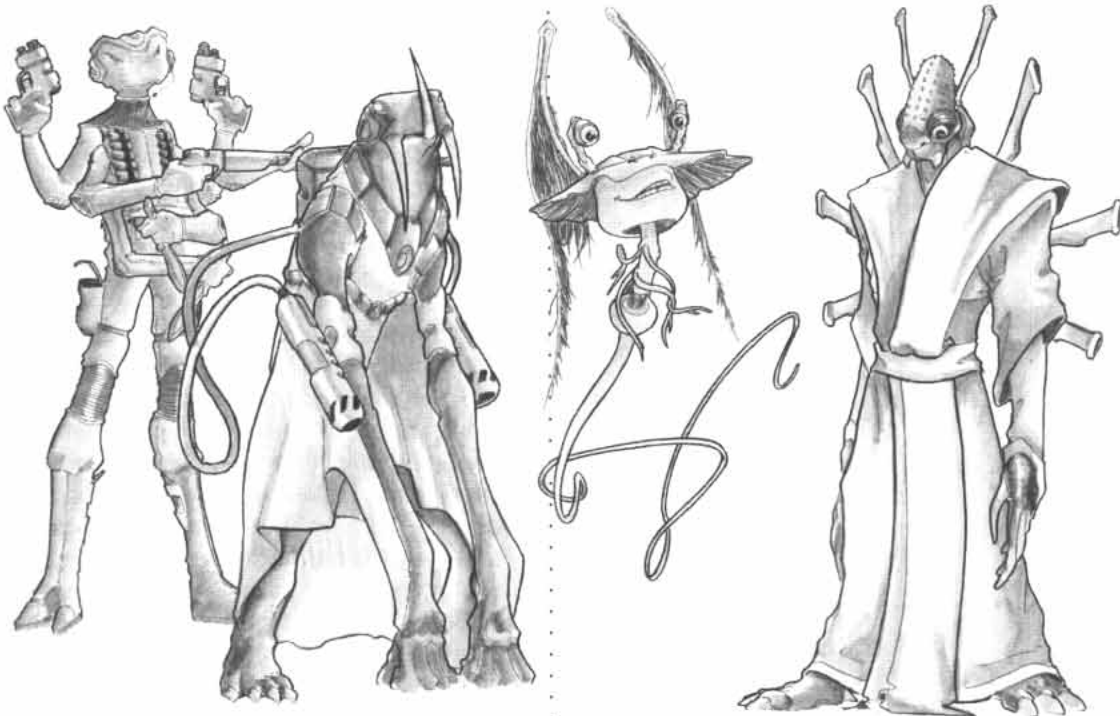

• **People of the Five Galaxies**

The majority of the habitable star systems of the Five Galaxies are home to either primitive cultures (who are largely ignored by Galactic society), Dreamstate civilizations (who largely ignore Galactic society) and the various groups that have come in contact with CORE. There are a few exceptions, however: races that were brought into the modern age by external sources (often CORE, if a D'vor fleet was approaching or attacking) or that developed space flight independently, but never progressed to the Dreamstate status for some reason.

The "orphan" races are often bitter or ambitious, having been thrown into a larger picture without adequate preparation. Their colonies are found in a restricted area of space (how restricted depends on the type of faster-than-light drive technology they have managed to acquire), and beyond those borders only small groups of individuals will be found.

The latter are often mercenaries or adventurers who left their homes behind in search of greater fortunes in the galaxy. They are rarely the most moral of their kind, and tend to share a rough, selfish attitude towards the universe at large. Some individuals (often working for CORE or an affiliated service) make up the exceptions.

• **Game Uses**

The following races were created using the guidelines found in the *Silhouette CORE Rules* manual, under the heading 6.2 *Alien Races and Modified Humans*. They are used in the same fashion as the other sample sentient races found in the *CORE Command Players' Handbook*.

All the races presented here can be used to generate both Player Characters and Non-Player Characters. Some of them are openly friendly or hostile, but a lost or isolated colony (or simply an individual that decides not to follow the rules) can be used to justify characters of an opposite outlook.

• Aracknati

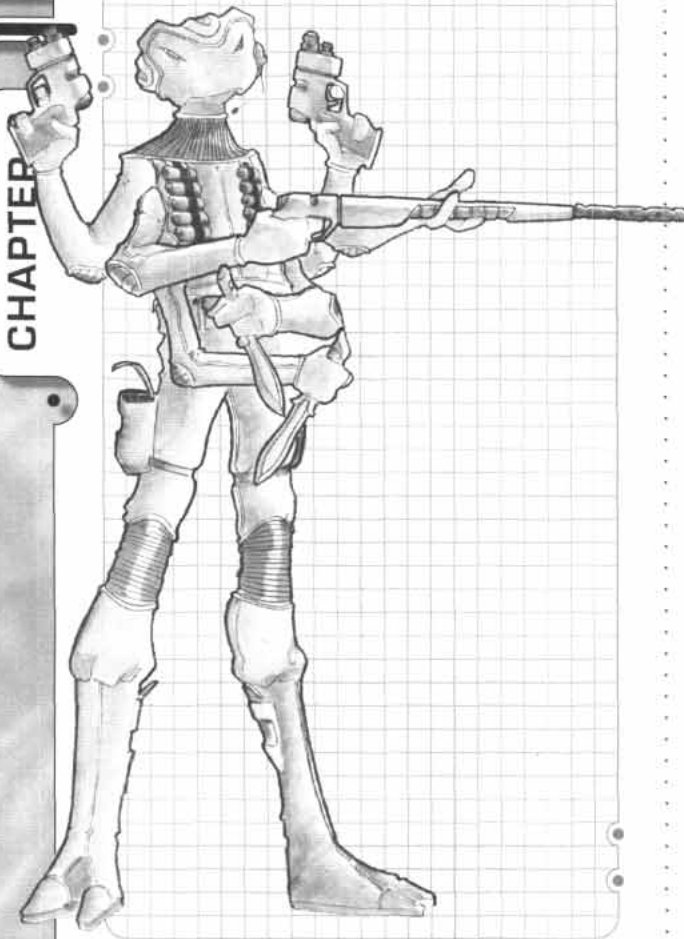

• Description

Sometimes known as the 'weapon masters' of the galaxy, the Aracknati are renowned for their skills with ranged armaments of any kind. Their numerous limbs make them adept climbers, and the ability to gain height while maintaining a weapon or two trained on the enemy makes their competence with ranged arms truly deadly. While not necessarily the brightest race, they are quick thinkers and better than average at multitasking, both side benefits of a brain which developed parallel neural paths to coordinate eight limbs performing constant functions.

Those that venture the universe do so primarily as mercenaries, seeking to achieve vast wealth and/or fame. Their services are often in demand in hostile places, where their weapon skills, penchant to use them, and urge to display their prowess make the Aracknati valuable companions indeed. For the right price, there are few tasks they won't do, and few places to which they wouldn't venture.

As individual Aracknati become successful and famous, they attract a following of fellow kinsman with whom they form a bond akin to a master-apprentice relationship. These young Aracknati offer their services in return for a small fee and the experience they need before setting out on their own. Though the arrangement is always informal, it is rare to find two 'apprentice' Aracknati from the same home settlement training together. They would be too busy competing with each other to cooperate effectively, and the senior Aracknati would gain no benefit from a second tag-along with the same local knowledge and contacts.

Personality: Aracknati tend to be flamboyant characters, often showboats and sometimes outright arrogant. Though they are capable of using multiple weapons at once, in absence of the threat of combat to maintain their focus, they tend to exhibit a short attention span and an absent-minded nature. This should not be mistaken as vulnerability, however, as they are alert individuals and are never found without a weapon or three. They are also proud characters, and while greed is a significant factor in their 'for hire' lifestyle, they will hold personal grudges and perform services for nothing more than a shot at avenging a past slight.

Physical Description: The Aracknati are tall, lanky humanoids with six arms. All of their hands sport three fingers: one thumb, one index digit and one grasper. Likewise, each foot has three toes, one larger than the other two. A complex bone structure in the torso holds sockets for the arms and legs; while it can bend forward, it has only limited traverse. The head is flat-faced and large, with no apparent nose. The eyes are placed widely



apart, which helps account for the Aracknati's superb depth perception. Aracknati are highly coordinated individuals in general, and have no problem employing multiple tools and weapons at the same time.

Relations: Aracknati tend to have at least cordial relations with the other races, as they travel where, and with whomever, their employment takes them. Usually they focus on building their own personal reputation and relationships, and pay little heed to diplomatic necessities. They do have a tendency to rub some of the more timid races the wrong way with their brash behavior, but usually make sure not to totally alienate them. Such people are usually the most likely to pay a third party to do their dirty work.

Place of Origins: To the Aracknati, the notion of an 'origin' or original planet is a foreign concept, as the need to associate oneself with a starting point only indicates one hasn't accomplished enough. There are Aracknati settlements in all five galaxies, as successful adventures retire to a favorite location, to which others are drawn by the retiree's fame and wealth. These settlements are often found on worlds colonized by other races, who tolerate their presence if for no other reason than in the event of an attack. The Aracknati have proven themselves adept defenders of their homestead (and the homes of others — for a price). These colonies rarely grow very large however, as young Aracknati are constantly leaving to build their own fame and fortune, and to start a new settlement which will of course be bigger and better than the one they left.

Communications: The various colonies and worlds inhabited by the Aracknati have their own dialect, but all are based on a series of clicks and chittering. They can learn Galactic without problem, and virtually all off-world Aracknati speak it. It is not unusual for the more traveled Aracknati to pick up some common phrases of other languages as well, though they rarely remain in one place, or with one employer, long enough to attain fluency.

• **Silhouette Template**

Aracknati are standard Silhouette characters, as defined in the Silhouette CORE rulebook. Their Attributes range from -3 to +3 in all categories except the followings: AGI -2 to +4, BLD -4 to +2, INF -4 to +2, PER -2 to +4.

Aracknati can take any of the Skills listed in the rulebook (section 2.2) and any of the basic Perks and Flaws. They have access to all the professions (unless specifically indicated otherwise).

Aracknati have excellent depth perception and keen eyesight: add +1 to their Skill test for any ranged attack at Long or Extreme range.

Aracknati can use up to three tools or weapons at a time without penalty, provided they are all used against the same target.

• **Open Gaming Content Template**

- Aracknati are Medium-size characters.
- Dexterity +2, Constitution -2
- Aracknati have a base speed of 30 feet.
- Ranged Targeting: Aracknati have excellent depth perception and keen eyesight. Their range increment penalty is -1 instead of the standard -2.
- Aracknati can use up to three tools or weapons at a time without penalty, provided they are all used against the same target.

• Hiscan

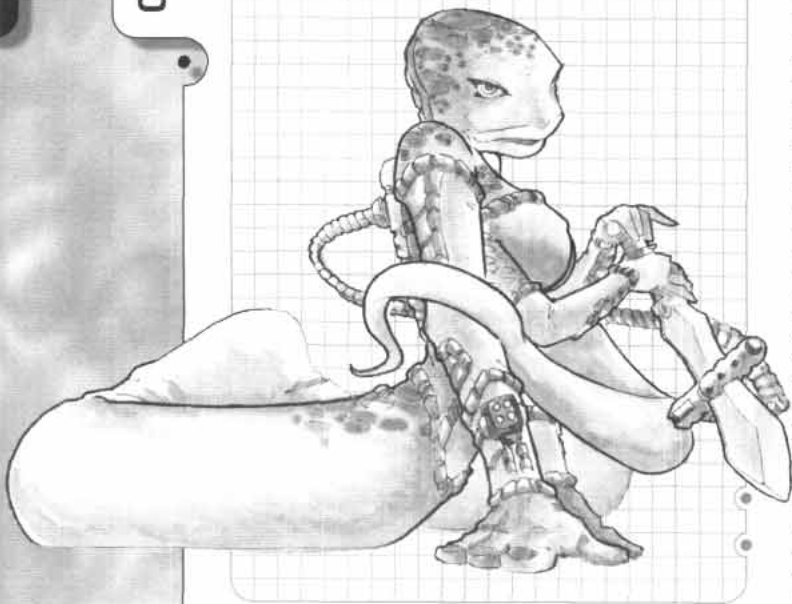

• Description

The Hiscans are a very stealthy and secretive race that value their autonomy and anonymity above all else. Though they maintain relations with the CORE Alliance as matter of prudence, they are very suspicious of CORE and have a very strong distaste for the never ending stream of meddlesome CORE scientists that come to conduct 'studies.' Rarely are these visitors well received, and the few who are allowed to carry out their work are fed a steady diet of misinformation.

While Hiscans are comfortable on land and in space, they are by far best suited to aquatic environments. Hiscans can breathe

underwater, and use both sonar and a temperature sensing ability to 'observe' their aquatic world better than any visual capability could. Their sonar and ability to sense heat are also useable on land, albeit at reduced effectiveness. They have settlement areas on land to facilitate trade and the reception (and containment) of visitors, but to get to the heart of any Hiscan colony one must travel beneath the waves. The fact that rarely anyone bothers to do so only encourages their disdain for most land-dwellers.

In conflict situations Hiscans will submerge if at all possible, always preferring to rely on stealth for both attack and defense when they can. They are capable of delivering a venom attack which will immobilize the victim, and often results in the victim drowning though the venom is not fatal on its own. Underwater they can also use their powerful tail to strike opponents. On land their tail is not an effective weapon, but they can balance up on it to use their strong upper set of arms to strike if necessary.

Personality: Hiscans are a cautious lot, generally averse to risk and loath to enter a battle. They are not pushovers, however, and do not take kindly to prying eyes and shady characters. They have regular festivals centered upon races and other physical competitions, but these always occur beneath the waves and a detailed account of what goes on is not known. Amongst themselves they share a strong sense of community, and any outsider who earns their trust (a rare occurrence) will be treated as one of their own from then on. The few who have done so report that, despite the reserved behavior that Hiscans are commonly known for, they are actually amazingly outgoing individuals.

Physical Description: Hiscans are reptilian-like beings, though they are not actually reptiles. They have an elongated torso that ends in a long, muscular tail, and four arms, two of which are significantly stronger. This upper pair of manipulator arms double as legs, with the palms of the hand being covered in calloused skin. Most Hiscans can also rear up and slither

on their tail alone if need be. The lower pair of arm is the primary means of manipulating tools.

Relations: The Hiscan have good relations with the various Grob clans (see **Core Command Player's Handbook** chapter 5) that travel in their region of space, and frequently trade with them. What other races would consider friendly Hiscan often find nosey, and thus prefer the abrupt, right to the point manner of Grobs, which other races often find rude. Their friendship with the Grobs puts them at odds with the Zees (see next page), though outright conflict between the two is rare, as Zees tend to steer clear of Hiscan.

Place of Origins: Due to their secretive nature, it is hard enough to obtain current information regarding Hiscan colonies let alone facts of a historical nature. It is known that Hiscan live reasonably long lives and show an interest in the history of their communities. Therefore it is not unreasonable to presume some record of their origin has been maintained. If so, however, they have given no indication that they will reveal any of it. Currently they have colonies on worlds in both the Spiral and Andromeda galaxy, but there is little to pinpoint where they arose first.

Communications: While Hiscan can learn spoken languages, they are often difficult to understand, speaking with a very deep voice and slurring their speech as they tend to run words together. This is as much the result of a lack of effort as any inherent inability. Amongst themselves they communicate in one of two fashions. On land they rely primarily on gestures augmented by hissing and tail thumping sounds. Underwater, however, their hiss and tail vibrations combine to produce low pitch sonar waves, capable of transmitting detailed information over great distances.

• **Silhouette Template**

Hiscan are standard Silhouette characters, as defined in the **Silhouette CORE rulebook**. Their Attributes range from -3 to +3 in all categories except the followings: CRE -2 to +4, FIT -4 to +2.

Hiscan can take any of the Skills listed in the rulebook (section 2.2) and any of the basic Perks and Flaws. They have access to all the professions (unless indicated otherwise).

Hiscan have 2/3 the normal Attribute-derived movement rate. They can triple this rate once per minute, throwing maximum effort into a lightning-quick tail movement. They swim at their full movement rate.

Hiscan bites deliver a, Potency 8, Onset Time 1 round, paralytic toxin.

• **Open Gaming Content Template**

- Hiscan are Medium-size characters.
- Constitution -2, Intelligence -2
- Hiscan have a base speed of 20 feet. They can make a 60' charge once per minute — a lightning-quick tail movement. Hiscans swim at a base speed of 30 feet.
- Hiscan bites deliver a DC 16 paralytic poison lasting 10 rounds.
- Hiscan tail deal normal kicking damage underwater.

• Zee



• Description

Zees are locked in a never ending battle with their primary food — Grobs. As a race that feeds on another sentient creature, they find themselves unpopular in most regions of the galaxies. Fortunately for Zees, most other races do not think very highly of Grobs either, and will thus usually ignore the carnivorous aliens, or even welcome their presence as a mean of control on the Grobs activities. Kabayans (see *Core Command Player's Handbook* chapter 5) employ Grobs as laborers and slaves, and will often trade them to Zees once they have served their purpose.

When Zees raid a Grob trade ship, they usually enjoy the feast then take the cargo to its intended destination, where they sell it off at a discount. This serves to placate the local communities which overlook the Zee activity in their neighborhood as long as the desired supplies arrive. To counter this, Grobs have refused to deal with settlements or whole planets that do not provide some protection. To most worlds, this threat is laughable, in part because Grob ships carry an insignificant percentage of their trade, and in part because Grob ships are known to raid other vessels themselves. But to a few remote locations, barter with Grobs is an important source of supplies, and they have begun to assist the Grob's security concerns to ensure their trade connections are not interrupted.

There is a fringe element of Zee society that feels feeding on Grobs is an outdated and unnecessary practice and hunting them is a waste of time and resources. These disenchanted individuals believe that technology can provide a suitable dietary replacement, and they could then move away from a primarily violent nomadic lifestyle. They would prefer to join CORE and direct society's resources towards 'higher' pursuits. Those that share this radical view are few and far between, and most Zees consider them a trivial nuisance. Community leaders, however, take it upon themselves to know who these radicals are and to insure they cannot cause any significant dissent.

Personality: Zees tend to be aggressive and short tempered individuals, but also love fooling around. Males especially like rowdy, physical humor. Despite the objections of a small minority, most Zees do not give their violent lifestyle a second thought. Grobs are food, plain and simple. The need to trust one's combat partners and the dislike for Zees expressed by many other races cause Zee communities to be very close knit groups. There can be conflict between different Zee communities, however, especially in areas where the Grob population is declining.

Physical Description: Zees have hairless, leathery skin and elongated limbs. They lack a visible neck, their head seemingly growing out of their torso. Three vicious fangs jut from their mouth, which opens wide enough to bring them into play. When attacking with their fangs, Zees will bring their upper jaw down first, ideally on the top of the head, piercing the victim and holding it in place. The lower jaw then brings the decisive blow, the fang angled perfectly to sever through the neck of a Grob (or similar sized creature) if the Zee has struck from above. A large flap of loose skin links the arms and the legs, allowing the Zee to glide over short distances. Because of their physiognomy, they prefer to use self-directed weapons that free their arms for flight. A minute organ system in their chest can produce heat waves, which they can use to 'see,' especially when gliding down upon unsuspecting Grobs in the dark.

Relations: Zees hold uneasy relations with most other species. While few tears are shed on behalf of the generally unpopular Grobs, others are still uneasy around a race that feeds on other sentient beings. Over time, a collection of rumors has formed around this cannibalistic procedure. Some suggest that Humans are a popular second choice when Grobs were unavailable, but those in the know suggest that Zees avoid such practice for fear of drawing unwanted attention from CORE.

Place of Origins: Zees are believed to have originated, with the Grobs, from a sector near the edge of the Spiral galaxy, though there is no actual hard evidence for this. They currently roam the trading routes of Grobs, raiding their ships and even whole colonies when possible. As Grobs spread through the galaxies, Zees are never too far behind.

Communications: Zees have their own language, made up of a combination of low pitched grumbling noises and high pitched shrieks. They also speak Grob, though unfamiliar dialects can result in translation error. They can use their infrared ability to trade crude messages with one another.

• **Silhouette Template**

Zees are standard Silhouette characters, as defined in the **Silhouette CORE rulebook**. Their Attributes range from -3 to +3 in all categories except the followings: BLD -1 to +4, FIT -2 to +4, KNO -4 to +2, PSY -4 to +2.

Zee can take any of the Skills listed in the rulebook (section 2.2) and any of the basic Perks and Flaws. They have access to all the professions (unless specifically indicated otherwise).

In addition to its ground movement, Zee can glide, moving three meters forward per one meter of altitude lost. They cannot gain altitude unless above a thermal.

• **Open Gaming Content Template**

- Zee are Medium-size characters.
- Strength +2, Constitution +2, Intelligence -2, Wisdom -2
- Zee have a base speed of 30 feet.
- Zee bites deal twice their normal kicking damage.
- Zee have a 30 ft. Darkvision.
- Zee can glide, moving three meters forward per one meter of altitude lost. They cannot gain altitude unless above a thermal.

• Bando



• Description

The Bando are a very intelligent species that live in a highly organized and stratified society. Clan colors and a rank rack are on display at all times, as to do otherwise is considered a grave insult by any fellow Bando who bears witness. Such an insult is cause for exile or severe punishment unless it can be shown a result of some extreme circumstance.

Bando possess unique psychokinetic abilities, though they are purposely ambiguous regarding their full capabilities. They do not use this power unless necessary, and never use it just to show off. The Bando have long held that this is an innate skill, which through

heightened concentration allows them to harness a mental energy used to influence physical objects, though the nature of this 'power' has recently begun to cause quite the controversy. Some CORE scientists have begun speculation that this is in fact a technological means, which, as members of the CORE alliance and recipients of other alliance members' technology, the Bandos are supposed to share. A few have carried the speculation one step further, suggesting that the Bando's insistence upon always wearing ceremonial dress is to disguise the true purpose of the apparatus they don. Bando leaders angrily deny the accusations, but have yet to offer any evidence or candidates for study as some of their inquisitors have demanded. In fact they have increased security surrounding all their diplomatic and trade missions, claiming they fear this baseless slander will cause a backlash with potentially violent results. The cynics, however, find this further evidence that they have something to hide.

Bando are not physically imposing figures, and with the exception of a few highly trained elite guards, are generally not proficient with melee weapons or at hand-to-hand combat. Their psychokinetic abilities, however, means they present a threat even when unarmed. Most common is for Bando to use their psychokinetic power defensively, to avoid being hit (a blunt weapon or fist is slowed down enough to be dodged, a laser is nudged off target, etc) but there are stories told of Bando, left with no other option, literally crushing opponents with sheer willpower alone. It's doubtful that these stories are true, or that such is even possible, but the Bando are quite happy to let such rumors persist as a deterrent to anyone with malicious intent.

Personality: Bando are usually thoughtful, polite, and generous, though sometimes visitors feel that the respect the Bando accord them with is less than sincere. This is because Bando are intellectuals who think twice before acting. They don't express their emotions very often nor particularly well as behaving

excessively emotionally goes against their strict sense of decorum. Instead they rely on their elaborate ceremonies and rituals to convey feelings. The acting out of part or all of a certain custom, combined with the mental images Bando share, will easily convey to other Bando a mood better than any verbal indicators could. Thus to an outsider Bando can seem dispassionate or even disingenuous.

Physical Description: The Bando are tall, thin humanoid individuals with a large bulbous head from which five feeding tentacles dangle. They generally wear elaborate robes and a ceremonial back rack that showcases their kinfolk's colors.

Relations: As members of CORE, Bando participate in a wide range of diplomatic endeavors. They generally play the role of mediators and conciliators, and get on well with various human groups who share this outlook. Recently, however, as questions regarding their psychokinetic ability are being asked with increasing frequency and malice, the Bando have decreased their diplomatic activity.

Place of Origins: Among Bando historians, the solar system of their origin is a hotly debated topic, but it was most certainly one in the Doradis galaxy where the majority of Bando worlds are found. They now also have colonies in all other galaxies except for Trianguli, where they maintain only a handful of small moon outposts for trade and diplomatic purposes.

Communications: Their psychokinetic abilities allow Bando direct mental communication, but in the presence of outsiders they will often use Galactic Standard or one of several human languages instead. The Bando also have their own audible language and they like to use one or more audible languages in tandem with their mental communication, making following a Bando conversation quite an arduous task, even when it sounds like a familiar language is being used. This has also earned them a bit of a reputation as double-talkers, as people will accuse Bando of changing their minds

because of mistaken conclusions drawn from hearing what was in fact only half the conversation.

• **Silhouette Template**

Bando are standard Silhouette characters, as defined in the **Silhouette CORE** rulebook. Their Attributes range from -3 to +3 in all categories except the followings: BLD -4 to +1, INF -4 to +2, KNO 0 to +4.

Bando can take any of the Skills listed in the rulebook (section 2.2) and any of the basic Perks and Flaws. They have access to all the professions (unless specifically indicated otherwise).

• **Silhouette Template**

- Bando are Medium-size characters.
- Constitution -1, Intelligence+2, Charisma -1
- Bando have a base speed of 30 feet.

• **The Secret**

Bando don't have any inherent mental abilities, albeit they will always strongly deny the fact and go to any length to hide this from others. The secret of their power resides in their staff and ceremonial rack, which are housing for primitive (but powerful) Quantek devices.

A staff can house up to three Quantek devices and the rack up to seven, although the actual number is governed by the status of the individual within Bando society.

• Tansol



• Description

Tansol have a long and storied past. Ancient records suggest they may have been the first multiple planet species in all of Andromeda. They have also survived through a long period of regression, in which civil war laid colonies to waste. Fortunately the conflict fell short of complete annihilation, and what was left of the Tansol's once proud empire was united under the influence of the first great 'Eselsparkismunk,' or spiritual leader.

Barter and haggling had always been a part of Tansol society, but after their great war this became the enterprise of choice. The need for resources to rebuild, combined with a ravaged

infrastructure incapable of more than meager production, left the Tansol no choice but to set out into space *en masse*, trading anything and everything they could for desperately needed goods.

While the benefits of advanced technology is fully obvious to any space faring society, the experience of their great war left many Tansol feeling wary of the power of destruction that such advanced technology can cause. In place of the scientific progress that had shaped Tansol society up to that point, they turned to ancient texts previously the domain of only historians and scholars. These texts proscribed a philosophy of living emphasizing internal balance and spiritual harmony. The Tansol have not produced any significant technology of their own since then, preferring to live relatively simple lives, and to trade for what they need. Their motivation for joining CORE was largely to avoid having to rebuild their own defense forces, which would have been woefully inadequate against the latest weaponry anyway.

Hence Tansol worlds are largely populated by the too young and too old. The majority of mature Tansol spend their time in space, using their bargaining skills to eke out an existence as traders, and hopefully enlighten a few of their customers along the way. Tansol outpost settlements have been setup throughout all five galaxies, which serve as a base for operations and supply depots for external trade. The settlements also coordinate amongst themselves to create a huge internal trade network, which ensures each colony and settlement gets the supplies it needs.

Personality: Tansol are very humble, to the point of being infuriatingly so. They always seem to be paying tribute to unseen guides and benefactors. They tend to be empathetic, surprisingly good at judging individuals of other races' character and emotional state, despite rarely giving away clues as to their own. This skill is cultivated in young Tansol, as it aids immensely with the negotiation inherent to their inevitable future merchant career. Some

would say they completely lack a sense of humor, but this, of course is not true. They just have a tendency to be serious individuals, especially when it comes to business.

Physical Description: The Tansol are humanoid beings with long arms and comparatively short legs. Their elongated head sports vestigial mandibles and numerous short horns. They have two eyes, one of each side of the head, which can focus independently and are protected by segmented eyelids. Two breathing tubes extend from just behind their eyes, right above the hearing pits. Six more tubes emerge from the Tansol's spine.

Relations: Tansol are, first and foremost, traders. Over their long history, they have come to rely on other races to build their tools and supply them with food. They get on particularly well with the Orb-Shakra (see *Core Command Player's Handbook* chapter 2) whom are always willing to engage in trade. They are also missionaries, hoping to plant the seeds of a connection with the spiritual world that other species so consumed by advanced technology seem to completely lack. This makes them a nuisance to some, who would prefer to complete a transaction without enduring a life lesson first.

Place of Origins: The Tansol home world is found in Andromeda, though it is largely a collection of ruins now. A harsh environment to begin with, most species would find the atmosphere lethal, and evolving in such a place has made the Tansol particularly resistant to most poisons found on other worlds. Andromeda remains the only galaxy in which they maintain entire planet colonies, but they have settlements throughout the other four galaxies serving as outposts from which they conduct their business.

Communications: Tansol have their own language, consisting largely of eyelid flutters and chirping sounds. They can also generate low pitch resonance vibrations from their

breathing tubes, which can be used to send signals over longer distances. Most speak Galactic Standard as well to facilitate business with other races.

• Silhouette Template

Tansol are standard Silhouette characters, as defined in the *Silhouette CORE* rulebook. Their Attributes range from -3 to +3 in all categories except the followings: BLD -4 to +2, PSY -2 to +4, WIL -2 to +4.

Tansol can take any of the Skills listed in the rulebook (section 2.2) and any of the basic Perks and Flaws. They have access to all the professions (unless indicated otherwise).

• Open Gaming Content Template

- Tansol are Medium-size characters.
- Constitution -2, Wisdom +2
- Tansol have a base speed of 30 feet.

• Aki

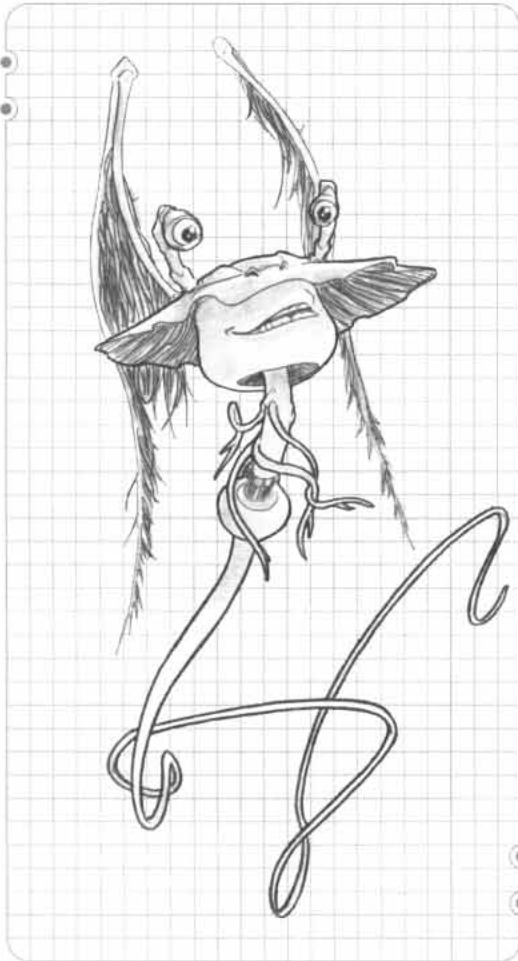

• Description

The Aki are best known for their chameleon capability, allowing them to appear any combination of dull and drab or brilliant and dazzling colors. Combined with their ability to fly, it should not be surprising that they find themselves in high demand as scouts and spies for militaries across the galaxies. They can also generate an electric charge with their tail, and the thought of scores of camouflaged Aki descending upon their opponents to then strike with the force of a lightning storm is enough to give pause to even the most determined foes. They are sure to weigh heavily on the scales of any conflict they chose to attend.

Both their chameleon and electrocution abilities are the result of one of the most complex physiologies of any biological organism. The Aki themselves take these talents for granted, but CORE scientists have long tried to unravel this mystery. Unfortunately, but not surprisingly, Aki are not particularly willing to subject themselves to experimentation for the benefit of CORE research. A few studies have been completed through secret observation and examinations of recovered Aki casualties, but the information learned is incomplete.

What is known is that an Aki's entire body seems to function like a small electromagnetic field, though the mechanisms by which they do this are completely unknown. This electromagnetic field is constantly absorbing and releasing electromagnetic waves, and can be altered by the Aki to produce their few different abilities. They can absorb different sets of light waves and thus appear different colors. They can also emit different light waves and actually glow a desired color for a time. And through their tail they can rotate the field locally to produce their feared electrical attack. This attack temporarily drains them, however, and thus they need a few moments to 'recharge' before they use it or their chameleon endowment again.

While this unique physiology bestows upon the Aki some amazing powers, their electromagnetic field also makes them vulnerable, as they can be subject to devastating results if exposed to electromagnetic weapons. There is also speculation that a fine tuned electromagnetic field generator could be used to detect and/or confuse otherwise invisible Aki. To date, however, none has been developed for this purpose.

Personality: Aki are usually pleasant mannered individuals. They love to jest and misbehave, and seem to be unconcerned with the problems that interfere with the daily life of others. To some degree, however, this is in part due to the ultra serious nature of their work as advanced scouts and explorers.

On Aki colonies, where one finds Aki in a more normal distribution of employment, they still tend to be fun loving individuals, but not to the same extent.

Physical Description: The Aki are mostly made of a long, fine tail that emerges from underneath what looks like a cross between a mushroom and a head. Two fine wing-like structures bob out from the top, right behind the stalks that hold the eyes. Small tentacles grow around their tail, which the Aki can use to manipulate objects. The Aki move by floating about, thanks to their innate magnetic field, low density and high-speed wing movements. This method is not particularly precise and, while they can move about rapidly, they are somewhat clumsy.

Relations: Aki have some sort of relationship with all other races, or at least their military. They are always being recruited to assist with intelligence gathering, yet the same employers are constantly trying to devise defenses against Aki employed by their opponents. Some cynically suggest that Aki don't actually spy at all, but since some are working for all nations, they just get together and exchange information. This highlights the main problem with employing Aki, in that one can never be sure where an Aki's allegiance lies. They have been known to work as double agents, and it is rumored that they work with other militaries only for the ultimate goal of some nefarious scheme to benefit Aki society.

Place of Origins: Nobody is sure where the Aki came from, though the most commonly accepted location is in the outer edge of Tucanaeon a madly rotating planet with a liquid silver core. They now have loosely affiliated colonies in every galaxy.

Communications: Aki have their own languages, but they are quite capable of speaking Galactic (albeit with an atrocious, child-like accent and grammar). Their audible languages, each with numerous dialects, are so diverse it is not uncommon to find two Aki that can't understand each other's native tongue. They also have a complex sign

language, however, that conveys meaning through colors, positions and motions of their tail, wings, tentacles, and eye stalks, and is universally understood by all Aki.

• **Silhouette Template**

Aki are standard Silhouette characters, as defined in the **Silhouette CORE rulebook**. Their Attributes range from -3 to +3 in all categories except the followings: AGI -4 to +2, BLD -5 to -1, CRE -2 to +4, FIT -4 to +2, PER -1 to +4, PSY -1 to +4.

Aki can take any of the Skills listed in the rulebook (section 2.2) and any of the basic Perks and Flaws. They have access to all the professions (unless specifically indicated otherwise).

Aki can float between 0 and 3 meters off the ground, moving at twice the calculated movement rate for their Attributes.

Aki's electrical attack is usable once per hour: Acc 0, BR Melee, DM x16+Haywire.

All Akis automatically have Disguise 3/1.

• **Open Gaming Content Template**

- Aki are Medium-size characters.
- Strength -4, Dexterity -2, Constitution -4, Intelligence +2, Wisdom +2, Charisma +2
- Aki have a base flight speed of 60 feet (Poor).
- Aki's electrical attack is usable once per hour and deals 5d4 electrical damage with reach.
- Aki have a +8 racial ability to all Hide checks

• Centar



• Description

Centars are not a naturally evolved species like most others, but in fact were developed through genetic manipulation by the Gargeni, a particularly hostile and ruthless race of Humans. Originally bred as beasts of burden, the Gargeni quickly realized the potential benefits of their own personal subordinate brutes, and soon had Centars performing all kinds of tasks on their behalf. Originally not very bright, Centars seem content to live out such an existence, having never known any other. While such behavior was frowned upon by CORE, other than a diplomatic reprimand and suspension of certain privileges, no action was taken against the Gargeni.

An ambitious lot, it was not long before the Gargeni came to the conclusion that they could accelerate their aggressive expansion by using Centars in combat, thereby minimizing their own casualties. To be effective warriors they needed constant supervision, however, and soon the call went out to the genetic engineers to develop a more intelligent Centaur. The engineers were successful beyond anyone's imagination, but what was a stunning achievement of science would also prove to be a fatal mistake.

It did not take long for the new generation of fully sentient Centars to question why they were doing all the working and fighting while their human masters sat in comfort and safety reaping the spoils of Centar efforts. Discrete contact with CORE was made, and although officially CORE was never involved, several human races, already concerned with the threat the Gargeni were becoming, provided assistance with a Centar revolution.

The Gargeni put up a valiant fight, but with Centars forming the bulk of their fighting force for nearly a century, they lacked significant numbers of their own soldiers, and those they had lacked any real combat experience. When defeat became certain, the Gargeni fled, and although they are rumored to have reestablished themselves somewhere in the Trianguli galaxy, they have not been heard from since. The Centars, now in control of their own destiny, have thrived ever since, though they still are considered an inferior species by some who feel their creation was an atrocity.

Personality: Centars tend to be very upbeat and pleasant individuals. When young they are constantly reminded of the hardship of their ancestors, which tends to impress upon them an optimistic outlook of their current freedoms. They are easily excitable and are even spooked on occasion, resulting in a temporary urge to flee from wherever they happen to be. This sensation is particularly common when trapped indoors for extended periods, and Centars traveling on small

spaceships generally carry mild sedatives to help them cope with spending a long duration in a confined area.

Physical Description: Centars have humanoid upper bodies, with two manipulator arms, multiple digit hands, and an elongated head. Their lower body is horse-like, complete with four powerful yet graceful legs to support them and provide motion and a tail which aids balance.

Relations: Centars are particularly friendly with the human civilizations that assisted them in their battle for freedom, and though over a millennium has passed, are still exceedingly grateful. Now full members of CORE, they maintain at least minimal diplomatic relations with all major sentient species. They are particularly distasteful of Kabayans (see **CORE Command Player's Handbook** chapter 5) for their continued practice of using slaves and in general will frown upon confrontational or overtly aggressive behavior.

While this leads them to be known as pacifists, the truth is that they have military teams constantly preparing to fight to ensure they, or any of their allies, will never be subservient to others again.

Place of Origins: Centars were first conceived in the mind of Dr. Thad La'Dor, a bioengineer working at a covert unsanctioned gene lab in the Equidae System of the Spiral galaxy. Nobody is quite sure what went on in that lab, and in addition to the Centars tales of abominations of all kinds being created there persist to this day.

What is certain is that after successfully winning their freedom from their masters and recognition from CORE, the first thing the newly acknowledged race did was dispatch a team to locate this lab and unravel the secrets of their genesis. What they found is unknown as the returning team became unshakably close-mouthed and only disclosed the complete destruction of the laboratory along with the enclosed information.

Communications: Centars are one of the few races without their own language, speaking primarily Galactic Standard to avoid using the language of their former human masters. Their humanoid vocal cords allow them to speak most common audible languages, and it is not unusual for the average Centaur to know all the languages of the fellow races they come in regular contact with. Though not widely known, Centaur leadership has developed a unique sign language code to allow for private and covert communication when necessary.

• **Silhouette Template**

Centars are standard Silhouette characters, as defined in the **Silhouette CORE** rulebook. Their Attributes range from -3 to +3 in all categories except for: BLD 0 to +5, PER -4 to +2, PSY -2 to +4, WIL -4 to +2.

Centars can take any of the Skills listed in the rulebook (section 2.2) and any of the basic Perks and Flaws. They have access to all the professions (unless specifically counter-indicated).

Calculate the movement rates normally, then multiply by two. Their body structure, however, prevents them from crawling and they may thus not use this movement mode.

Centars may kick targets behind them, causing double the normal kicking damage for their size/strength.

• **Open Gaming Content Template**

- Centars are Medium-size characters.
- Strength +2, Constitution +2, Wisdom -2, Charisma +2
- The Centar base speed is 50 feet. Centars cannot crawl.
- * Centars may kick targets behind them, causing double the normal kicking damage for their size/strength.

• Nep'ta'le, Ta'le and Trekkla



• Description

Ta'le are non-sapient arboreal predators. They are quite agile, fairly intelligent and they have exceptionally well-developed senses. They are highly social animals, living and hunting in packs of 12-20. Ta'le have fairly large brains, but most of their cerebral structure is devoted to processing sensory information rather than higher level thought.

Over many millennia, certain Ta'le have developed a symbiotic relationship with an unusual neural parasite. The Trekkla parasite rewires the large Ta'le brain, changing it from a sensory processor into a more flexible thinking machine. This dulls the Ta'le's senses

but dramatically boost their intelligence, raising these Nep'ta'le to true sapience. While the most dramatic changes occur during the first five weeks, the neural reconfiguration process is a constant one. The Nep'ta'le brain naturally tries to revert to its natural form, forcing the neural parasite to make continuous modifications. Specific facts and information tend to fade over time.

The Nep'ta'le and Trekkla reproduce separately (the former by bearing live young, the latter by laying eggs). At adolescence, the most promising young Ta'le receive the neural parasite while the rest are turned out into the wild or put to other uses (see *Webbling*, further). This is effectively a eugenics program, ensuring that only the most capable members of the species survive to breed the next generation.

If the Trekkla parasite is ever killed or removed, the Nep'ta'le will revert to non-sapience. Over the course of about five weeks, intelligence will decline and individual personality will gradually be submerged by animal instinct. This process is a severe psychological trauma. Most Nep'ta'le will respond by either withdrawing into a morose depression or becoming suicidally aggressive. In either case, death often results before reversion is complete. Loss of one's Trekkla is regarded as a fate worse than death, making it the harshest possible penalty under Nep'ta'le law. Replacing one parasite with another is possible, but the neural rewiring completely wipes out the preexisting personality and memories.

Personality: The Nep'ta'le have a highly hierarchical social structure and behavior depends almost entirely on the relative difference in perceived rank. A Nep'ta'le will give anyone of higher rank deference, ranging from mere politeness to meek obeisance. Those of lower rank receive anything from slight rudeness to haughty contempt.

The only Nep'ta'le trait that outweighs rank behavior is their territoriality. Even a Nep'ta'le of much higher rank will ask for permission to enter another's domicile. If someone enters without permission, it is almost certain to

provoke a violent response, even against suicidal odds.

Physical Description: The Ta'le are small, four limbed creatures covered in a fine, brown fur. Their eyes and ears are quite large, a testament to their highly developed senses. Ta'le forelimbs sport retractable claws and their mouths contain many small sharp teeth.

The Nep'ta'le are identical to their less intelligent cousins, save for the Trekkla neural parasite. The parasite is basically hemispherical, with a light blue chitin exoskeleton. When attached to a Nep'ta'le, the Trekkla appears like a large skullcap or small helmet (leading to the derisive use of the term "helmet heads" by some other races).

Relations: It is difficult for most Nep'ta'le to regard any creature that does not have the benefit of a neural parasite as truly sapient, which tends to color their relationships with other races. While the sapience of other species can be proven on an intellectual, scientific level, most Nep'ta'le still instinctually regard anyone without a Trekkla as unworthy of attention.

Place of Origins: The Nep'ta'le home world and most of its colonies are concentrated in the Tucanae galaxy, but they can be found in lesser numbers throughout the five galaxies.

Communications: The Nep'ta'le language is composed mostly of growls, screeches and hisses. Their excellent senses make them capable of communicating using a wide variety of non-verbal cues, including scent. Nep'ta'le can also learn to communicate with wild Ta'le, though the primitive structure of this communication limits the expression of complex concepts.

• **Webbling**

The Nep'ta'le have always used their less intelligent cousins as guard animals, trackers and even cannon fodder. More recently they have turned to webbling to allow the Ta'le to be used for more sophisticated tasks. Webbling involves connecting an animal's brain to a computer network, increasing both its intelligence and its receptiveness to commands. Webbled Ta'le are commonly used for menial or dangerous tasks.

SilCORE Game Mechanics: Webbling is only possible with large and rather intelligent animals (Instinct -1 or higher, Build -6 or higher). Webbling gives an Instinct bonus of +1 and a Willpower penalty of -1 (when resisting commands). Webbled animals can be taught relatively simple skills. Each Skill Point requires one week of training and the maximum Skill level is 2 (or 2 levels higher than a naturally occurring skill). Complexity can never exceed 1.

OGL Game Mechanics: Webbling is only possible with large and rather intelligent animals (Intelligence 2 or higher, Size Small or larger). Webbling adds 2 to intelligence. The webbled creature will obey its master (acts as a permanent Charm Person or Animal spell, plus a -5 penalty to all opposed charisma checks). Webbled animals can be taught relatively simple skills. Each skill rank requires 1 week of training, (maximum 4 ranks for any skill).



• SiLCORE Stats — Nep'ta'le

Nep'ta'le are standard Silhouette characters as defined in the Silhouette CORE rulebook. Their Attributes range from -3 to +3 in all categories except the followings: AGI 1 to +4, BLD -4 to +1, CRE -2 to +4, KNO -4 to +2, PER -2 to +4.

Nep'ta'le receive five more Character Points during character creation but subtract five points from their starting Skill Points. They can take any of the Skills listed in the rulebook (section 2.2) and any of the basic Perks and Flaws. Nep'ta'le claws add 5 to their UD.

If a Nep'ta'le is ever separated from its neural parasite, reduce INF, KNO and PSY by 1 per week until they reach -5, then add 2 to PER. At this point they are treated as a creature rather than a character (CRE becomes INS).

If the parasite is restored, reduce PER by 1 and increase INF, KNO and PSY by 1 per week until they reach their original values.

• OGL Stats — Nep'ta'le

- Nep'ta'le are Small-size characters.
- Dexterity +2, Constitution -2, Intelligence -1, Wisdom +1
- Nep'ta'le have a base speed of 25 feet.
- Low-light Vision: Nep'ta'le can see twice as far as a human in starlight, moonlight, torchlight and similar conditions of poor illumination. They retain the ability to distinguish color and detail under these conditions.
- If a Nep'ta'le is separated from its neural parasite, reduce its Intelligence, Wisdom and Charisma by 2 per week until they reach zero. They are now treated as a creature rather than a character. If the parasite is restored, increase these attributes by 2 per week until they reach their original values.

• Flowers for Algernon

The Trekkla parasite of an important Nep'ta'le dignitary has been stolen and the PCs have been assigned to retrieve it. They must track down the parasite in time, while keeping the increasingly unstable dignitary under control.

• **SilCORE Stats — Ta'le**

Attributes: AGI +2, BLD -2, FIT 0, INS +1, PER +3, WIL 0, STR -1, HEA 0, STA 15, UD 5

Skills: Combat Sense 2/1, Defense 1/1, Hand to Hand 2/1, Athletics 2/1, Stealth 2/1, Notice 2/1

Special Attack: Claws (x5 Damage)

Move: 35 m/round

• **OGL Stats — Ta'le**

CR 2; Small Animal; Hit Dice 4d4; hp 8; Init +8 (+1 Size, +3 Dex, +4 Improved initiative); Speed 35 ft.; Defense 15 (+1 Size, +3 Dex, +1 Natural), Touch 14, Flat-footed 12; BAB +3; Grap -1; Atk +3 Melee (1d6, Claws); SV Fort +3, Ref +5, Wil 0; AP 0; Rep 0; Str 10, Dex 16, Con 8, Int 2, Wis 11, Cha 6

Skills: Climb +8, Balance +14, Jump +8, Move Silently +15, Spot +6, Listen +6

Feats: Improved Initiative, Weapon Finesse (claws)

• **SilCORE Stats — Trekkla**

Attributes: AGI +1, BLD -7, FIT -1, INS -3, PER -2, WIL 0, STR -4 HEA -1, STA 1, UD 1

Move 1 m/round, Armor Rating 10

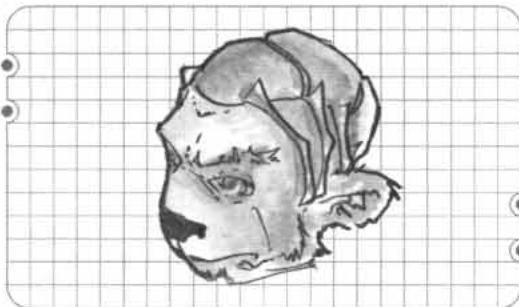

• **Experimenting with Trekkla Parasites**

The players have been ordered to investigate a group of renegade scientists attempting to use Trekkla neural parasites on other races, trying to create a genius from already sapient species. Unfortunately, neurological incompatibilities have left all of the experimental subjects gibbering idiots. Unknown to the PCs, a Nep'ta'le team has been sent in with similar orders, to prevent the "misuse" of the Trekkla parasites.

• **Ta'le Bloodhounds**

The Nep'ta'le consider their non-sapient cousins mere commodities, and are not above selling them to other races. One particularly popular product are webbled Ta'le trackers. Their enhanced senses and high level of intelligence make them nearly impossible to elude. Use the standard Ta'le stats with webbling modifications and the maximum allowable level of the Notice or Tracking skill.

• **OGL Stats — Trekkla**

Cr 1; Diminutive animal; Hit Dice 1/8d8; hp 1; Init +3 (+4 Diminutive, -1Dex); Spd 3 ft.; Defense 13 (+4 Size, -1 Dex), Touch 13, Flat-footed 13; BAB 0; Grap -17; Atk none; SV Fort -8, Ref -3, Wil -3; AP 0; Rep 0; Str 1, Dex 8, Con 1, Int 1, Wis 5, Cha 4

Skills: none

Feats: none

Removing a Trekkla attached to a Nep'ta'le head requires an opposed strength test. For the purposes of such a test, treat the Trekkla as if it had a strength ability modifier of +3.

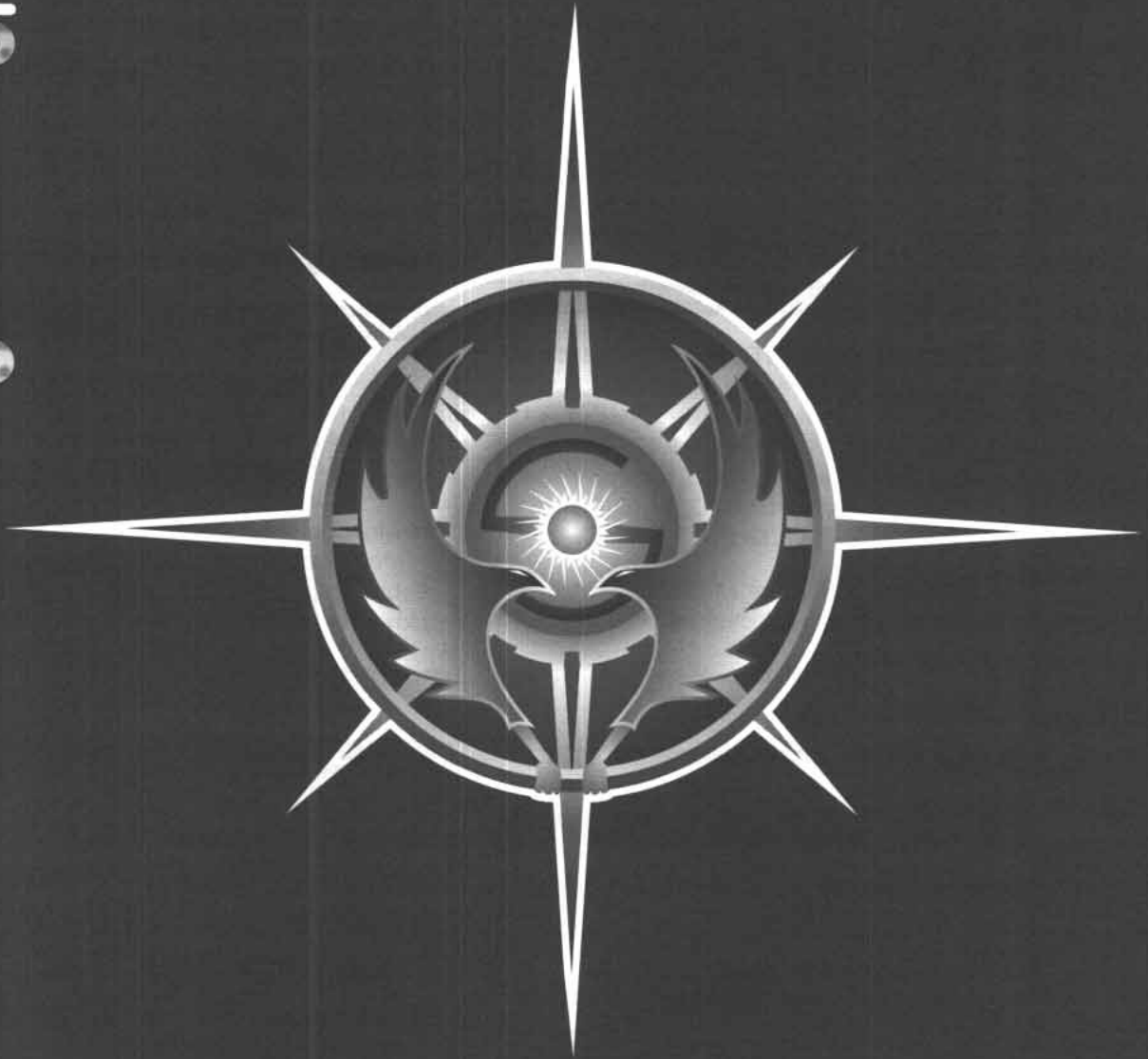

CHAPTER 3:
Flora And Fauna

• The Albitoi Swarm



• Description

Otherwise known as the Landfall Scourges or the Living Brushfires, the Albitois are alien creatures of gregarious nature that could be distantly related to rodents. A single specimen stands on two sets of legs and exhibits razor-sharp claws and fangs, along with a tail-mounted sting that can dispense a virulent oncological toxin. Albitois share a luxuriant fur, as soft as velvet, but otherwise show incredible individual variation in their physiological traits, ranging from a chitinous exoskeleton to gills and feathers. This subtlety is often lost on the observer who will most likely face an Albitoi Swarm, made of 50-500 such creatures moving as one screeching, carnivorous carpet.

The Albitoi metabolism is unbelievably fast, their cells dividing the way fireworks explode. An Albitoi never pauses in its lifetime, ignoring sleep and satiating its hunger by tearing pieces off what crosses its path. Reproduction is either accomplished sexually while running at full speed or through a macromolecular adaptation of binary fission when sex proves too complicated. Small Albitoi clones bud off the side of both sexes to fall fully formed to the ground. Very few have the good fortune not to

be devoured by the Swarm upon birth. In comparison, other life forms pose little threat to Albitois. A Swarm will incessantly roam planetary surfaces, repeatedly growing and dividing. Undeterred by major obstacles, it will eventually exhaust resource poor planets. The swarm will then rapidly turn upon itself, self-devouring and leaving behind a handful of hibernating, bloated members. These burst to life and begin dividing as soon as planetary conditions become hospitable again. Victims of Albitoi poison have been found to have undergone accelerated cellular division, leading to the postulate that the toxin also serves some regulatory function among the Swarm.

Intact Albitoi fur is very popular on many less developed worlds. The pelt of just one creature, undamaged, will fetch 200-300 credits in the right marketplace.

• SiLCORE Stat Block

Swarm Attributes: Aggressiveness 5, Damage/Turn 7, Damage Threshold 30, Random Horde Size 6d6, Basic Swarm Size 100

• OGL Stat Block

Albitoi Swarm Creatures: CR 1; Small Vermin; HD 1/4d8; hp 3; Mas 10; Init +2 (Dex); Spd 60 ft., Climb 30 ft.; Defense 13 (+1 size, +2 Dex); BAB 0; Grap -7; Atk +3 Melee (1d2, Bite), Full Atk +3 Melee (1d2, Claws), +3 Melee (1d2 & Poison, Sting); FS 5 ft. by 5 ft.; Reach 5 ft.; SQ poison; AL none; SV Fort +2, Ref +3, Will +0; AP 0; Rep +0; Str 1, Dex 15, Con 10, Int —, Wis 10, Cha 2.

Skills: Climb +8, Hide +13, Spot +7

Feats: Weapon Finesse (bite).

Advancement: None

Poison: The tail of the creature is tipped with a barb that generates a neuro-toxin.

• Blood Worms

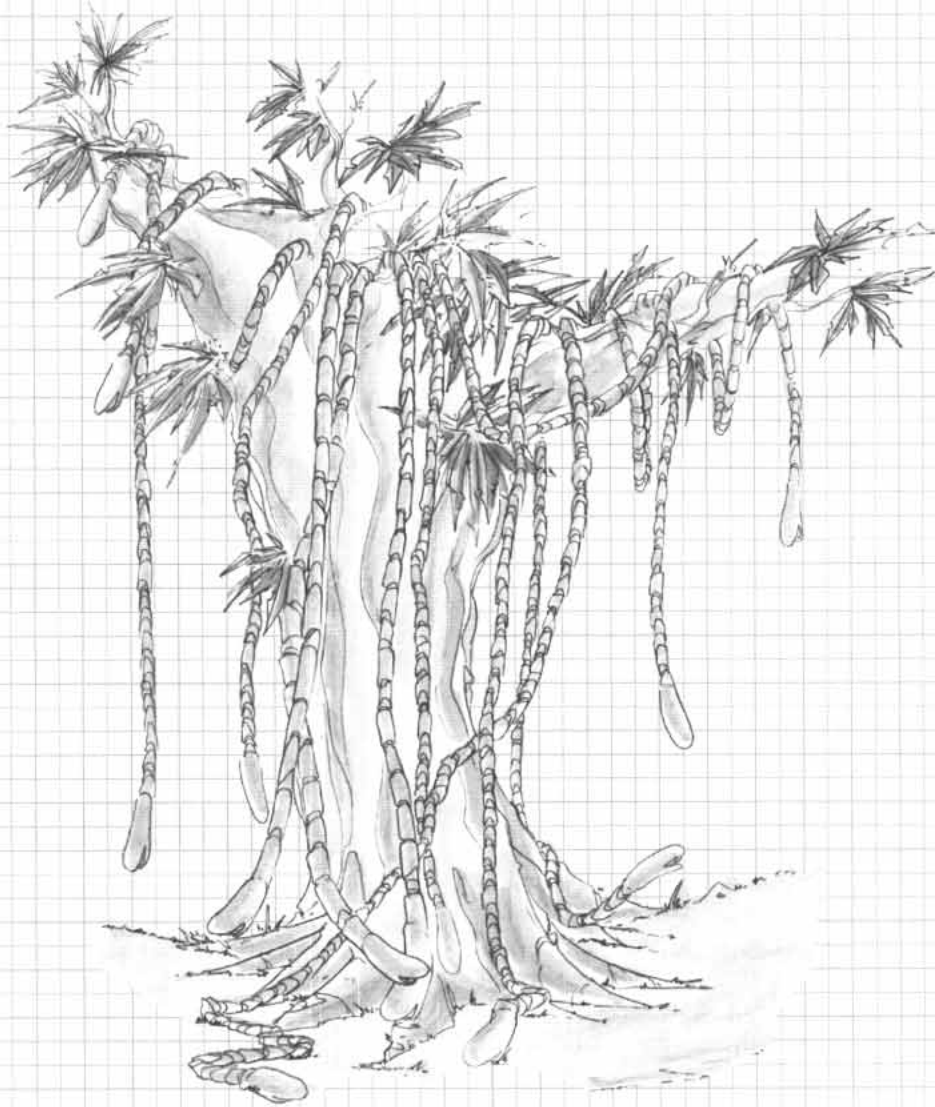

• Description

The very existence of the Blood Worm's symbiotic relationship blurs the distinction between flora and fauna. Preeminent sages across the five galaxies disagree over which of the plant or the animal evolved first. The Blood Worm extracts vital fluids from the living beings it snares and provides essential nourishment to its host, the Blood Worm

Tree. Yet, it derives equally crucial bio-compounds from the plant and rapidly perishes if separated from its symbiont's substratum. To date, the only consensus is to label it a parasite with regard to everything else it interacts with.

The lignified Blood Worm Tree grows twisted burnt-like appendages up to dozens of meters in length. Unlike other trees, it branches



extensively from its point of inception at ground level, and extends homogeneously above and below grounds, with no distinctions between roots and shoots. The mature form of the plant, if it could be fully seen, would be reminiscent of two gigantic wooden crowns placed bottom to bottom. On this scaffold lives one or more Blood Worms which resemble pitch black lampreys up to twenty feet in length. These whip-like worms attack and entangle passing animal life. They firmly anchor their hind end to the tree and either snake out in the air so as to resemble low-lying branches or swing down nervelessly in the fashion of dropping vines. Their attack is sudden and consists of an autonomous reflex on the Blood Worm's part, which snaps to buffet and coil around a passing life form, crushing it to death while secreting a bio-compound that forcefully 'sucks' fluids out of the victim's body. The entity's rudimentary intelligence gives rise to other strategies, such as to attack from covered burrows delved from the Blood Worm Tree's underground section.

The worm snakes nimbly among the tree branches and disappears within carved out limbs of the Blood Worm Tree if seriously wounded. If separated from its host, it dies as would a fish stranded on land. The statistics are for the worm itself. The tree does not attack and is treated like a regular tree for all game purposes.

• **SilCORE Stat Block**

Attributes: AGI +0, BLD +6, FIT +2, INS +2, PER +0, WIL +0, STR +3, HEA +0, STA 55, UD 14

Skills: Combat Sense 2/1, HtH (Grapple) 2/2, Disguise (Camouflage) 2/1, Defence 2/1.

Special Abilities: Blood drain — after initial round of grappling, base UD increases to 16 to simulate extra trauma from blood loss.

• **OGL Stat Block**

Improved Grab: as follow up to a successful slam attack.

Constrict: a Blood worm inflicts 1d6 + 7 constriction damage with a successful grapple attach each round holding its prey.

Blood drain: Through osmosis in the body of the 'worm' itself; the held victim must each round make a Fortitude save vs. DC17 or lose 1-2 Con points.

Blood Worm: CR 2; Large Animal; HD 4D8+12; hp 30; Mas 16; Init 0; Spd 30 ft (see notes); Defense 15 (-1 size, +6 natural); BAB 3; Grap 10; Atk: +7 Melee (1d6+7, Slam); Face 15ft. by 15ft.; Reach 20 ft; SA improved grab, constrict, blood drain; SQ camouflage, blindsight; AL none; SV Fort +7, Ref +1, Will +2; AP 0; Rep +0; Str 20, Dex 10, Con 16, Int 2, Wis 13, Cha 8.

Camouflage: When hidden within the hidden boles of the Bloodworm tree, a successful Spot check (DC 20) is required to see the worm before it attacks.

Blindsight: the worms need no light to see.

• Dargesh

CHAPTER 3

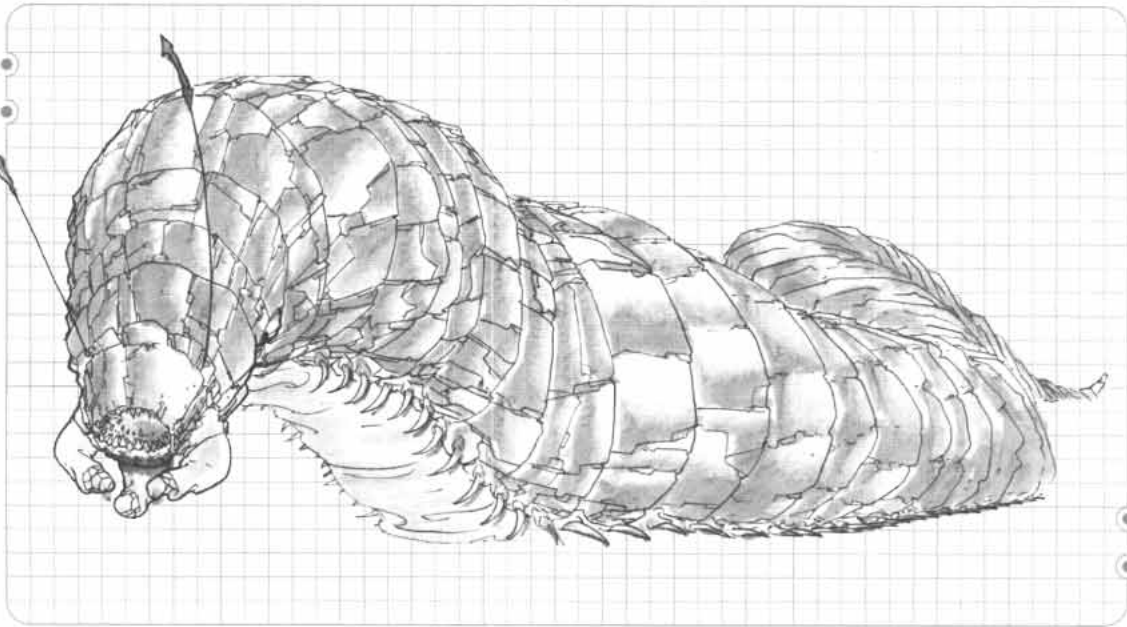

• Description

The Dargesh is a multi-limbed, silicon-based creature whose anatomy approximates that of a 10-meter-long millipede. The shells covering the segmented limbs are partly transparent, revealing the inner organs of the creature. The organs adopt strangely regular geometrical shapes, fooling some into believing the Dargesh is a mechanical construct and not a living creature. The Dargesh lives preferably in very cold climates and underground caves.

The most unique feature of a Dargesh at the molecular level is its replacement of carbon based compounds with silicon based ones. Of course, this also gives rise to a number of surprising features at the macro-level. Notably, a Dargesh does not breathe. It needs not eat carbon based creatures nor oxidize them through the process of respiration to live. Instead it tunnels through planetary crusts and hungers for the silicone veins found underneath. It extracts the energy and forms the biological building blocks from these through an almost random molecular process that baffles all scientists, based as it is on

molecular resonance but lacking any further pretenses of organization. There is little water in a Dargesh, the basic liquids filling its interstitial cavities being mainly cyclo-hexane and other small hydrocarbons. This gives the Dargesh its ability to withstand extremely low temperatures. Combined with the rigid structure of a Dargesh's body and its absence of need for air, it also allows them to float freely in space unharmed. Dargesh are asexual and live up to eight hundred years. Young Dargesh develop in their parents, with one offspring occupying one segment of the parent. An adult Dargesh will give birth to about a thousand progeny every century.

Dargesh are large pests that can be found in all five galaxies. On planetary settings, they will create a honeycomb of underground channels with a few select openings to the surface. These they will instinctively survey everyday in order to eliminate any threat that enters their territory. Multiple Dargesh will link their caves into a sprawling complex. Civilized planets informed of the presence of Dargesh will immediately take drastic action to wipe them out completely as they are well aware of

the consequences ensuing from an unchecked Dargesh infestation. The underground burrows incessantly expanded by the Dargesh will gradually mine the structural integrity of the planetary crust, eventually leading to the collapse of major cities and the impossibility of building any kind of heavy construction henceforth. Dargesh have also been found floating in space. There they aimlessly drift in hope of impacting their favorite meal: spaceships. The presence of a spaceship with its unusually high content of silicone will send a Dargesh in a feeding frenzy followed by rapid duplications. It will burrow through the ship's structure, creating structural breaches in record time. The loss of the few Dargesh that chew on the ship's reactors are negligible in comparison to the large number of young Dargesh produced. Space travelers are warned of the threat of entering a Dargesh field. These are marked and regularly updated on CORE's maps, although the information always remains probabilistic.

An attacking Dargesh will strike out at its enemies with its fanged mouth in a succession of deadly bites. It will also jerk its body around like an untangling telephone line to crush smaller threats. Dargesh are almost fearless and will keep fighting even after sustaining mortal wounds. Its most fearsome weapon is its sonic attack. Deep in the creature's gullet is an array of resonant crystals which it uses to generate a sound wave that can pulverize flesh and bone alike. The sonic attack sounds like an unhappy marriage between an opera aria and a buzz saw. This attack forms a cone that extends from the Dargesh's mouth and is 60 feet in diameter at its end.

A Dargesh is highly susceptible to its very own sonic attack. This somehow disrupts the resonant factor of its unique metabolism leading to a complete disorganization of the Dargesh molecular structure. A Dargesh will take triple damage from other Dargesh sonic attacks and double damage from other sound-based attacks. Each of the 10-20 crystals found in a Dargesh's mouth, if undamaged, are perfectly tuned to a specific note, and worth 500-2500 credits a piece.

• **SilCORE Stat Block**

Attributes: AGI -1, BLD +9, FIT +6, INS -2, PER +1, WIL 0

Secondary Attributes: STR+7, HEA +3, STA 85, UD 14

Skills: Combat Sense 2+1, Dodge 2/-1, Hand-to-Hand 2/-1. Small Arms (sonic weapon) 2/-1

Movement: 40m/round

Special Abilities: Slam (DMx20), Bite (DMx10), Sonic Attack (ACC 0, DM x30, BR 5m), immune to electrical attacks, Armor Rating 50

• **OGL Stat Block**

Dargesh : CR 6; Huge Animal; Hit Dice 9d10+40; hp 85; Mas 25; Init +1; Spd 60 ft, Burrow 15 ft (poor); Defense 20 (-2 size, +1 dex, +11 natural), touch 19, flat-footed 19; BAB 9; Grap 26; Atk +9 Melee (6d6+16, Slam); +9 Melee (1d6+8, Slam); FS 25 ft. by 5 ft.; Reach 20 ft.; SQ sonic attack (6d6 damage, Range 60 ft., -2 to hit), cold resistance; immune to electric attacks; AL none; SV Fort +11, Ref +4, Will +0; AP 0; Rep +0; Str 26, Dex 13, Con 25, Int 2, Wis 2, Cha 1

Skills: Listen +4, Spot +4

Feats: Improved Initiative

Advancement: 2-3 HD (Small)

● Drifters and Streamers ▼

CHAPTER 3

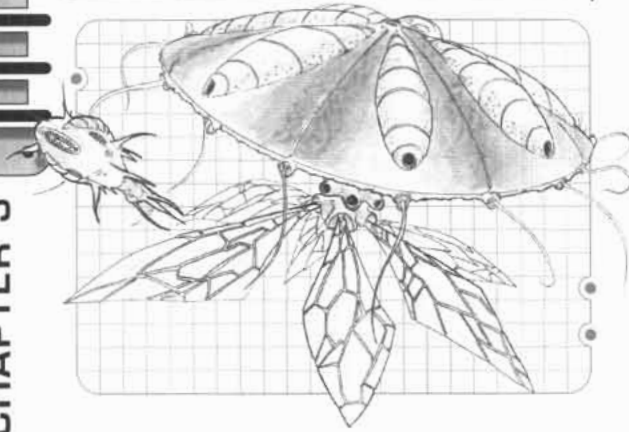

These are two distinct organisms that share a symbiotic relationship and live in the harsh upper atmospheric environments of gas giants. They are believed to have been originally genetically engineered by an ancient and unknown race for the purpose of harvesting the resources of these gas giants. The fate of their creators is a mystery and Drifters and Streamers can now be found on various gas giants primarily in the Andromeda galaxy.

When CORE scientists first discovered them, while certainly unique organisms living in a previously though uninhabitable environment, they were little more than a scientific curiosity. But since their true nature, and the purpose for which their creators made them was discovered, they have been one of the most studied and sought after creatures in the universe. Despite this, because of the difficulties in surviving, let alone working, in a gas giant atmosphere, there is much to learn about these creatures and progress is slow.

As part of their metabolic process, which is still not understood, some of the abundant hydrogen gas from the atmosphere gets converted to the much rarer and more valuable isotope of deuterium. Deuterium is sought after by all races of the galaxy primarily for its use in generating nuclear power, but it also has applications for such items as lasers, optical fibers, advanced semiconductors, and solar panels. As hydrogen is found virtually

everywhere in the universe, the ultimate goal would be to develop a Drifter that can inhabit safe stable environments, where collecting the deuterium produced would be infinitely easier. Currently, by the time one penetrates the unforgiving environment and overcomes the creatures' natural defenses, the energy used to do so is worth more than the deuterium gained. But it is no secret that several species are competing to be the first to devise a reasonably feasible method to harvest this new source.

● Drifters ▼

A Drifter resembles a large jellyfish-like organism, typically being twenty meters in diameter. The upper section of the Drifter houses several large chambers that are filled with heated gas, which keeps it afloat in the upper atmosphere, much like a balloon. By filling or expelling gas stored in the chambers the drifter will ascend or descend.

Often Drifters are observed clinging onto each other to form what looks like a single massive Drifter. Such a formation may contain several Drifters, up to but usually not more than 20. The purposes of these formations are not completely known, but it has been suggested that these formations are probably behavior once encouraged by their creators to facilitate collection of the gases they stored. Once connected, they rarely break their formation. They are completely passive creatures and would seem lifeless if not for the moving sails that hang from the bottom of their top membranes directing them through the upper atmosphere of a gas giant. They move as fast as the winds take them.

● Streamers ▼

These creatures provide for the defense of individual Drifters and Drifter formations. Each Drifter has several small compartments above the sail but below the lift membranes that house these Streamers. In exchange for the energy supplements produced by the Drifters that they receive, Streamers will attack any

threat to their host, or in the case of a formation, the entire group. The Drifters themselves never exhibit any behavior to suggest they are even aware of the presence other creatures and/or spacecraft. But through some sensory capability approaching objects are detected and the Streamers are immediately deployed. In large formations streamers from all Drifters present will deploy together, suggesting some sort of communication or stimulus exchange occurs among the group.

Streamers vaguely resemble a bag about 30 cm long with three pairs of swept back wings and a large opening in the front from which they suck in air and compresses it in their body before squirting it out of their rear in a jet like fashion for propulsion. They can travel at a speed of around 400 km/h and due to their small wings, they are very maneuverable. The front of Streamers has special organs placed around the 'intake' that produce an ionic discharge capable of electrocuting any attackers. They tend to attack in swarms, overwhelming the would-be attacker in seconds. It is not known if the individual Streamers can communicate with each other, or if this swarm behavior is simply the result of a common response to a common stimulus. Each Drifter usually has six Streamers living within them.

• OLG Stat Block — Drifters

Drifter: CR 1/2; Huge Animal; Hit Dice 6d6; hp 18; Mas 6; Init 0; Spd as fast as the wind, Fly (poor); Defense 11 (-4 size, +8 natural), touch 11, flat-footed 11; BAB 0; Grap 0; Atk none; FS 60 ft. by 60 ft.; Reach 30 ft.; SQ immune to electric attacks; AL none; SV Fort 0, Ref -3, Will 0; AP 0; Rep +0; Str 8, Dex 4, Con 6, Int —, Wis 3, Cha 2

Skills: Navigate +6 (sailing), Spot +4

Feats: None

Advancement: 2-3 HD (Medium), 4-5 HD (Large)

• SiLCORE Stat Block — Streamers

Attributes: AGI +2, BLD -2, FIT +3, INS +1, PER +0, WIL +0

Secondary Attributes: STR +0, HEA +1, STA 20, UD 3

Skills: Gunnery 2/1 (Ionic discharge), Piloting 3/1 (Flyer), Combat Sense 2/1

Special Abilities: Ionic Discharges (DM x12, Front arc, ACC 0, BR3, ROF 0, Unl. Ammo, Haywire, Attenuating Dam. -1)

• OLG Stat Block — Streamers

Streamers: CR 3; Small Animal; Hit Dice 4d4; hp 8; Mas 10; Init +8; Spd Fly (Poor) 2000 ft; Defense 15 (+1 size, +8 natural), touch 15, flat-footed 15; BAB 0; Grap 0; Atk +8 Melee (1d4+4, Slam); +8 Melee (6d6, Bite); FS 5 ft. by 5 ft.; Reach 5 ft.; SQ ionic discharges (1d10+2 damage, threat 18-20, crit. x2, RI 175 ft.), immune to electric attacks; AL none; SV Fort 0, Ref +5, Will 0; AP 0; Rep +0; Str 9, Dex 20, Con 10, Int —, Wis 14, Cha 2

Skills: Piloting (Flyer) +6, Ionic Discharge Proficiency +6, Knowledge (Tactics) +6

Feats: Improved Initiative

Advancement: 2-3 HD (Tiny)

• SiLCORE Stat Block — Drifters

Attributes: AGI -4, BLD +0, FIT +0, INS -2, PER -2, WIL -1

Sec. Attributes: STR +0, HEA -1, STA 20, UD 3

Skills: Navigation 2/1 (Sailing)

• The Fluidion

CHAPTER 3

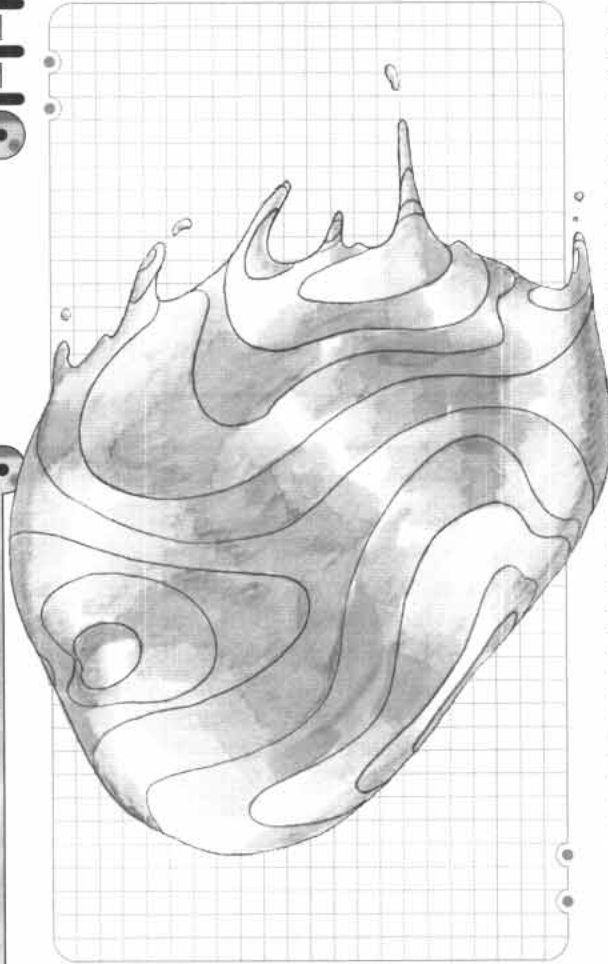

• Description

When news came of the complete loss of contact with the Colonial collective of the Jeu-Feh IV and its 4000 colonists, a team of CORE Agents was dispatched to discover the reason. What the team uncovered when they arrived was at first unclear.

The investigation discovered the terraforming generators, living quarters and most importantly the water treatment processors almost untouched and intact. Indeed at first some form off-world interference was suspected, as the world was selected for colonization because of the lack of any flora or fauna beyond single celled organisms and

plant bacteria. An engineering assessment of the water processors revealed the first piece of the mystery, an almost systematic destruction of the filtration and associated systems using blunt instruments of unparalleled strength.

After a good portion of the investigative team returned to the safety of orbit, the remaining surface team came under siege by the strangest of enemies: A living element. The CORE team soon found themselves in direct conflict with a creature they dubbed 'the Fluidion.'

As far as can be reconstructed from the team's testimony and the hastily made scientific data received, the Fluidion is actually a small creature, a highly specialized microscopic and multi-cellular plant based life form that in itself forms a collective intelligence. These micro cells in turn, through a complicated and mysterious process still not properly logged by CORE Scientists are somehow able to shape and control the water around them. Subsequently, the cells are able to surround themselves with a vast and animate body of water. The colossal entity consists almost entirely of semi-sentient, animate water that will fiercely defend itself from outsiders.

After heavy casualties the surface team was evacuated and the world of Jeu-Feh IV was placed under quarantine. Subsequent scientific missions to the world were planned but as yet despite the years no mission has been carried out.

• **SilCORE Stat Block**

Attributes: AGI -2, BLD +17, FIT +16, INS -2, PER 0, WIL +3

Secondary Attributes: STR +17, HEA +6, STA 138, UD 37

Skills: Combat Sense 5/2, Hand-to-hand (Grappling) 3/2, Defence 1/2, Natural Sciences 3/1, Survival 2/2.

Special Abilities:

Engulfing attack: May opt to use this attack in conjunction with any form of movement. Successful grapple ensnares opponent, pulling them at 10 meters/round towards the center of the creature's mass. Held target may attempt to resist, a contested Strength roll to escape. Victim of attack is to be treated as if drowning unless some form of breathing gear is worn.

Area Effect Attack: The Fluidon may move at a walking pace, enveloping all those whose path it crosses, as per the Engulfing attack above.

Armor: Fluidon almost immune to all known forms of physical attack and is considered to have the equivalent of an armor rating of 50 versus physical attacks, to represent its vast and malleable liquid form. The Fluidon can reform from destruction from any physical attack within a 96-hour period to full hit points. Energy weapons damage as per normal however.

Water Control: The Fluidon, if injured or if required to, may absorb further mass, growing to almost unbelievable weights of water mass. The creature may increase its size up to BLD +30, with calculated statistics adjusted as necessary. Access to a water body of comparable size allows the Fluidon to heal a Flesh Wound in five minutes or a Deep Wound in an hour.

• **OGL Stat Block**

Engulfing Attack: May opt to use this attack in conjunction with a full move, charge or slam attack. Attack engulfs opponent, pulling them at 30'/round towards the center of the creature's mass. Held target may attempt to resist, a swimming or strength roll versus difficulty 35 to escape. Victim of attack is to be treated as if drowning unless some form of breathing gear is worn.

Area Effect Attack: By taking a full move or charge action the Fluidon may engulf any opponents and subject any enveloped opponent as the engulfing attack above.

Damage Reduction 50/energy: The Fluidon is almost immune to all known forms of physical attack. Fluidon can reform from destruction from any physical attack within a 96-hour period to full hit points. Energy weapons damage as per normal however.

Water Control: The Fluidon if injured or if necessary may absorb further mass, growing to almost unbelievable weights of water mass. Treat as being able to 'grow' up to an extra 20 HD as required, as well as being able to heal at 20hp/round if it is within touching distance of a larger body of water.

Fluidion: CR 25; Gargantuan Elemental (water); HD 26D12+300; hp 456; Mas 48; Init 0; Spd 60 ft.; Defense 16 (+7natural, -8 size, -3 dex), touch 2, flat-footed 16; BAB 21; Grap 48; Atk +21 Melee (7d10+27, Slam); FS 60 ft. by 60 ft.; Reach 30 ft.; SQ engulfing attack, area effect attack, damage reduction 50/energy, water control; AL none; SV Fort +39, Ref -2, Will +9; Str 40, Dex 3, Con 48, Int 2, Wis 16, Cha 0

Skills: Bluff +10, Listen +10, Sense Motive +8, Knowledge (Planetary earth sciences) +8, Search +9, Spot +9.

Feats: Lightning Reflexes, Alertness, Great Fortitude.

Advancement: None

- Spectral Inha'azalass

No image on
file (invisible
creature)

- Description

The first Spectral Inha'azalass was discovered by a CORE exploratory team surveying a hulk of unknown origin in deep space sector UU-32CCXVIII near Grand Void Station. A purely psionic-based life form composed of 'psi-matter', the Spectral is not a physical entity but a tangled facsimile of emotions pooled from previous species the creature has encountered. Some argue it is not an entity at all but a self-perpetuating cycle of negative emotions interfering with intelligent creatures' brainwaves. No matter what, the creature is now classified as a lethal threat by all CORE agents.

The Spectral in itself cannot, and does not, create original thoughts. Rather it acts like a psychic parasite, stealing thoughts from its host and harnessing these to undergo its unique process of mental procreation. The possessed individual retains a measure of control over his own body but the best part of his reasoning is subsumed by the invading Inha'azalass. The host's thought process is transformed into a mixture of genuine feelings and pastiche memories forming the Spectral. Due to the invasive nature of the imposed mental propriety, most impulses seeping out are of a violent, pathological nature. An affected victim may behave normally but his psyche is regularly perturbed by thoughts not his own, giving rise to inconsistent speeches and contradictory actions. More ancient Inha'azalass will literally fragment the persona of the host into a collection of momentary split personalities. The switch between different mental predispositions is accompanied by a directly observable sign, ranging from a slight

facial twitch, a vocal interjection, to a complete subversion of the host's body to an outside force and the adoption of a fetal position. Lengthy observation of the victim often reveals recurrent sequences of behaviors. These are the memories of strong-willed former hosts that impressed more strongly on the Spectral. Orb-Shakras cultivate a deep-seated fear of Spectrals. The single recorded event of Orb-Shakra possession has led to uncounted miseries as the result of domination extended to other members of the race through their quantek mind-to-mind link. No Orb-Shakra working with CORE was willing to comment.

The Inha'azalass itself is normally invisible, but appears as a shimmering 'aura' if surveyed by the proper amplification/sensing devices. It is impervious to most forms of physical attack but is fully vulnerable to quantek strikes and will even yield to very well executed sessions of hypnosis. It will react strongly to the presence of a magnetic field, which makes it incapable of maintaining its mental dominion and causes it great pain, seemingly pulling the ghostly aura apart in a process akin to ripples forming in water. This vulnerability restricts the Spectral Inha'azalass' presence to deep space, where magnetic fields are rarer.

Lengthy examination of the Spectral is rarely an affordable luxury. Depending on the circumstances and emotional/psychic output of the possessed, the Spectral will have branched into two identical daughter forms within 24 to 48 hours and will quit the nest it built into the host's conscience. Released victims often collapse into a coma; depending on the ferocity, length and circumstances of the possession. The rare cases of lengthened possessions have left the recipients eternally scatterbrained.

The ontology of the Spectral Inha'azalass is unclear at best. A few crazed hermits and perturbed ghost hunters have chosen to actively pursue these creatures to uncover their purpose and origins. This has led to panoplies of hare-brained theories almost as numerous as the theorists themselves. Whether the 'Spectral,' as it has become classified, is a

naturally occurring entity, a D'Vor weapon or a failed experiment is to date open to debate. Recently, a widely renowned and long retired CORE taxonomist, Khael Waitlet returned from self-imposed exile with a valuable piece of information pertaining to these mysterious entities. Charting all five galaxies and compiling the distribution of Inha'azalass manifestations, he statistically tracked down their origin to a best fit quadrant in the spiral nebulae. Interestingly, the Spectrals' origin seems to be linked with that of the Orb-Shakra although Khael is still collecting data.

• **OGL Stat Block**

Spectral Inha'azalass: CR 4; Medium Outsider (incorporeal); HD 7d10; hp 35; Init +4 (Improved initiative); Spd 120 ft; Defense 10, touch 10, flat-footed 10; Atk: +7 melee (depending on possessed); +7 ranged (depending on possessed); Face/reach 5ft by 5ft; SA: possession; SQ: invisibility, if any; SR 7; AL varies but often evil; SV Fort +3, Ref +3, Will +15; Str -, Dex 10, Con —, Int 17, Wil 20, Cha 14

Skills and Feats: Improved initiative, Iron Will. Eight level 8 skills available, skills vary based upon individual entity.

Special Abilities: Possession- as per the Magic Jar FX spell (as as 10th level spell; Will Diff. 18 to save). One attempt per victim per hour, roll required for every three six hours of possession once gained. Otherwise functions as psionic ability.

Special Qualities: Invisibly as per the FX spell.

Spectrals typically possesses equipment and gear from current and sometimes the previously possessed dependant on circumstance.

• **SilCORE Stat Block**

Attributes: AGI +0, BLD +0, FIT +0, KNO -3, CRE +3, PER +2, PSY +3, WIL +3

Secondary Attributes: STR n/a, HEA +2, STA 35, UD n/a

Skills: Varies; typically Combat Sense 2/3, Psionic link at least two Combat Skills at 2/3.

Special Abilities:

Ethereal: cannot be affected by non-quantek physical/energy attacks and radiation, immunity to radiation and atmospheric effects.

Mental possession: If within 30 meters, able to anchor themselves to an individual. Victim makes a contested Will roll versus Difficulty 7 to resist, with bonuses or penalties as assigned by the GM according to emotional state and psionic based equipment. Allowed only one initial attempt, and three chances to resist once the Spectral runs its course.

Invisible: Spectrals cannot be seen without equipment that specially modulates thought patterns and/or detects psychic or psionic phenomena.

Faster than Human: moves at 2x human movement rates.

• **First Contact**

The CORE team codenamed Mythos-X35M established first contact with the Spectral. Charged with tracking down new spatial entities, the team was thrilled when it discovered a derelict ship generating a living signature of unknown origin. However, their excitement was cut short when the expert gunman left onboard trained all weapon systems at the recon group boarding the hulk. Over thirty hours later, the team recovered the lifeless body of their former companion floating in space. The cause of death was labeled 'anoxia' and the downtrodden team did not argue much over the perturbing neural scans they had obtained from the deceased.

• GolGoChans

CHAPTER 3

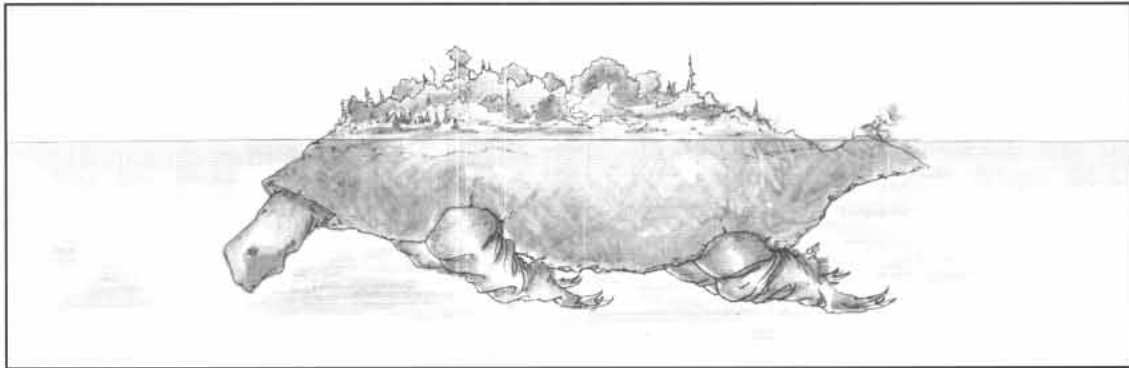

NATURAL ENVIRONMENT

• Description

Adult GolGoChans are massive beasts that placidly drift in the waters of their home world in semblance of a successful cross between turtles and icebergs. They float at the ocean surface with their shells exposed to the weathers and their undersides submerged. GolGoChans take over five millennia to mature, giving the plates on their back time to thicken to more than ten meters. As their metabolism is exceedingly slow, GolGoChans may not move for decades, turning them into living islands. They feed on plankton, kelp, and, occasionally, smaller animals that filter through their monstrous opened underwater maw.

GolGoChans form the pillar of the ecological food chains on their watery home. Their exposed hide sports luxuriant vegetation and serves as a haven for all sort of land-dwelling creatures while aquatic plants and small animals shelter in the underwater folds of their bodies. All adult GolGoChans secrete a thick, greenish nutritive substance from pores along their bodies, which drains off into the water and provide nutrients for the many small life forms nearby. As a result, a GolGoChan will always be surrounded by a vibrant array of living creatures. These in turn are the main source of food for the juvenile GolGoChans that surround the mature adult.

The juveniles, the sexually breeding stock of the GolGoChan species, are a good deal smaller than their parents. Both sexes look like sharks. The males breathe water through gills,

are highly territorial, and remain close to the adult, patrolling nearby. The females have a cartilage skeleton, grow large leathery wings and roam the skies from one adult to the next. Due to the hormonal nature of the nutritive chemicals secreted by an adult, its female offsprings will be driven away, while the males will remain close, thus preventing inbreeding.

Adult GolGoChans meetings are somber affair with neither party giving any outward sign of recognition. Yet, there is evidently some form of message exchanged as these meetings give way to occasional traveling herds of GolGoChans. These herds are beautiful sights that form extensive ecosystems whose complexity rivals that of continents.

GolGoChans are hard to rise in combat, but in the occurrence of an outside force succeeding in scoring a blow against one, a GolGoChan will rouse itself in terrifying anger. The perpetually open mouth will turn in a record time of a minute or so to clamp itself on the disruptive offender in hope of terminating the threat. In the event that a second wound is inflicted, a GolGoChan will dive to the depths of his watery home, dragging with it the unfortunate inhabitants of its back.

GolGoChans have spread to numerous worlds over two galaxies, though no one is quite sure how. On their native world where the ocean bottom reaches depths of sixty thousand feet, a local indigenous race speaks of the GolGoChan predator which, at least in their legends, assumes a cuttlefish-like mortal form.

• **SiLCORE Stat Block — Adult** ▼

Attributes: AGI -4, BLD +41, FIT +8, INS -5, PER -3, WIL +0

Secondary Attributes: STR +24, HEA +1, STA 235, UD 69

Skills: Notice 2/1, Defense 1/1, Hand-to-Hand 1/1

Movement: 40m/round

Special Abilities: Bite (DMx50), Armor Rating 50

• **OGL Stat Block — Male Juvenile** ▼

Male Juvenile GolGoChan: CR 2; Large Animal (Aquatic); HD 10d8+10; hp 50; Mas 18; Init +1 (Dex); Spd Swim 60 ft.; Defense 19 (-1 size, +2 Dex, +8 natural), touch 11, flat-footed 17; BAB 8; Grap 16; Atk +7 Melee (4d6+8, Bite); FS 10 ft. by 5 ft.; Reach 5 ft.; SQ scent; AL none; SV Fort +6, Ref +7, Will +8; AP 0; Rep 0; Str 15, Dex 18, Con 12, Int 1, Wis 16, Cha 7.

Skills: Listen +7, Spot +7.

Feats: Weapon Finesse (bite).

Advancement: 4-6 HD (Medium-size).

Climate/Terrain: Any aquatic.

Organization: Solitary, school (2-5), or pack (6-11).

Treasure: None.

• **SiLCORE Block — Female Juvenile** ▼

Attributes: AGI +3, BLD +4, FIT +2, INS +2, PER +2, WIL +2

Secondary Attributes: STR +3, HEA +2, STA 55, UD 10

Skills: Notice 2/1, Defense 2/1, Hand-to-Hand 2/1

Special Abilities: Bite (DMx15), Flight 120m/round, Armor Rating 20

• **OGL Stat Block — Adult** ▼

GolGoChan: CR 8; Colossal Beast; HD: 30d20+400; hp 700; Mas 32; Init -3; Spd: 60 ft.; Defense 30 (-10, -5 Dex, size, +35 natural), touch -5, flat-footed 30; BAB 25; Grap 66; Atk: +25 Melee (12d12+31, Bite); FS 120 ft. by 120 ft.; Reach 300 ft.; SQ swallow whole (on a critical hit with the bite, the GolGoChan will totally engulf its target, doing the bite damage every round), immune to electric attacks; AL none; SV: Fort +34, Ref -10, Will -2; AP 0; Rep +0; Str 61, Dex 1, Con 32, Int 3, Wis 3, Cha 10.

Skills: Spot +4

Feats: Endurance

Advancement: 49+ HD (Colossal).

Climate/Terrain: Any surface water.

Treasure: Chemical secretions, worth 1000Cr/liter. Adult generates 200-400 liters per day.

• **SiLCORE Stat Block — Male Juvenile** ▼

Attributes: AGI +2, BLD +6, FIT +3, INS +1, PER +2, WIL +1

Secondary Attributes: STR +5, HEA +2, STA 63, UD 14

Skills: Notice 2/1, Defense 2/1, Hand-to-Hand 2/1

Movement: 40m/round

Special Abilities: Bite (DMx15), Armor Rating 30, Aquatic Only

• **OGL Stat Block — Female Juvenile** ▼

Female Juvenile GolGoChan: CR 3; Huge Animal (Flying); HD 8d6+8; hp 32; Mas 12; Init +3 (Dex); Spd fly 120 ft. (poor); Defense 15 (-1 size, +2 Dex, +4 natural), touch 13, flat-footed 12; BAB 6; Grap 12; Atk +6 Melee (4d4+4, Bite); FS 10 ft. by 5 ft.; Reach 5 ft.; SQ keen scent; AL none; SV Fort +6, Ref +7, Will +8; AP 0; Rep 0; Str 15, Dex 18, Con 12, Int 1, Wis 16, Cha 7.

Skills: Listen +7, Spot +7.

Feats: Weapon Finesse (bite).

• Gornan

CHAPTER 3



• Description

Gornans are giant, savage beasts born and bred for carnage and destruction. They resemble gigantic semi-humanoid dinosaurs with metallic looking jaws and claws. Their exact origin is uncertain, veiled as it is by their current widespread dispersal in both the Spiral and Andromeda galaxies. An ancient code found on the smaller of the twin rogue planets, Dimedenua ??-675XXII and ??-675XXIII, provided the first hints that Gornans were not natural creatures but the genetic craftwork of an unnamed galactic race. Studies of the hereditary code of the Gornan indeed revealed a marvelously well ordered DNA integrally used for protein coding. This being a random probability of nihilistic proportions, it has led to CORE's classification of Gornans as genetical constructs with the master engineers behind their creation labeled as 'unidentified'.

The particular legacy of the Gornans' origin has lent them a superior metabolism. Their muscular fibers are perfectly aligned throughout their body, giving them a proportional strength fivefold of what would usually be expected at their size. Considering a Gornan is already the height of a one-story building, it is not surprising to see them routinely accomplish feats of might. For one thing, it is impossible to contain a Gornan in a cell made of any material of solidity lesser than and including reinforced steel, as the beast will escape after clawing his way through the walls. Similarly, the saying 'A Gornan needs no door but will always knock' is based on their habit of entering guarded complexes by piercing openings at random location, most often away from the conventional doors. Other reports tell of Gornans lifting rocks three times their size to crush offenders or preventing small spaceships from taking off by holding them with their bare paws.

In combat, a Gornan disposes of multiple means of attack. When opposing threats larger than itself, it will viciously rake with its claws. In the event that it manages to score a hit with both claws, it will secure them onto its opponent and bring its viselike mouth to bear. The later inflicts larger damages as it repeatedly tears into the trapped adversary.

Against small pestering creatures a Gornan will use its arms and legs independently, running over and trampling multiple victims under its large feet while swinging his arms in the melee with the intent of knocking the others over. The Gornan has also learned to recognize armed creatures and will concentrate its attack on them. It may grab armored individuals into its paws and weight on them the full extent of its strength, rapidly crushing them to death. Finally, Gornans are experts at camouflage, both in terms of behavior and physical endowment. Their skin is covered with minerals similar to metamorphic crystals. Each individual shard has as different tint and hardness on each of its facet and is left free to rotate over the underlying Gornan scales. These give the Gornan an incredibly tough skin as well as the ability to give its body the texture of most rocky environments. This the Gornan puts to good use by dissimulating itself among dispersed boulders to sleep or surprise its future challenger.

Gornans have long been used by militaries as advance fodder to test defenses. Before landing troops in a new combat zone, captured Gornans are deployed to run amok, drawing attention and wasting resources of the defenders. Ideally this tactic exposes the strategic plan of the target in question. However, results often vary since the Gornans are wild, solitary creatures that cannot be controlled. They behave in an unpredictable manner when in the presence of one another and, during deployment of leading hordes, will end up spending more time combating each other than the intended enemy. Nevertheless, the outcome remains the same as a fight involving several creatures this size always lead to extensive collateral damage.

• **SilCORE Stat Block**

Attributes: AGI -1, BLD +12, FIT +8, INS -1, PER +1, WIL -1

Secondary Attributes: STR+10, HEA +2, STA 95, UD 25

Skills: Combat Sense 2/1, Defense 2/1, Hand-to-Hand 2/1

Movement: 40m/round

Special Abilities: Slam (DMx20), Bite (DMx10), Armor Rating 20

• **OGL Stat Block**

Improved Grab: The Gornan must first hit with his bite attack.

Rend: A Gornan that gets a hold on its target starts to tear at it, causing 3d6+9 points of damage.

Gornan: CR 6; Huge Beast; HD 12d10 + 100; hp 160; Mas 27; Init -4; Spd 30 ft; Defense 20 (-2 size, -2 dex, +14 natural), touch 6, flat-footed 20; BAB 12; Grap 30; Atk +12 Melee 3d4+18 claws; Full atk +12 Melee 2d8+8 bite, 1d6+3 claws; FS 20 ft by 20 ft; Reach 10 ft; SQ scent; AL none; SV Fort +14, Ref +3, Will +0; AP 0; Rep +0; Str 31, Dex 6, Con 27, Int 3, Wis 2, Cha 5.

Skills: Hide +7, Spot +8

Feats: Weapon Finesse (bite).

Considering the danger, effort and trouble that capturing and transporting these creatures entails, however, many military commanders question the worth of such a strategy and advocate relegating these monsters to forlorn planets away from the main interstellar routes.

• Junko

CHAPTER 3

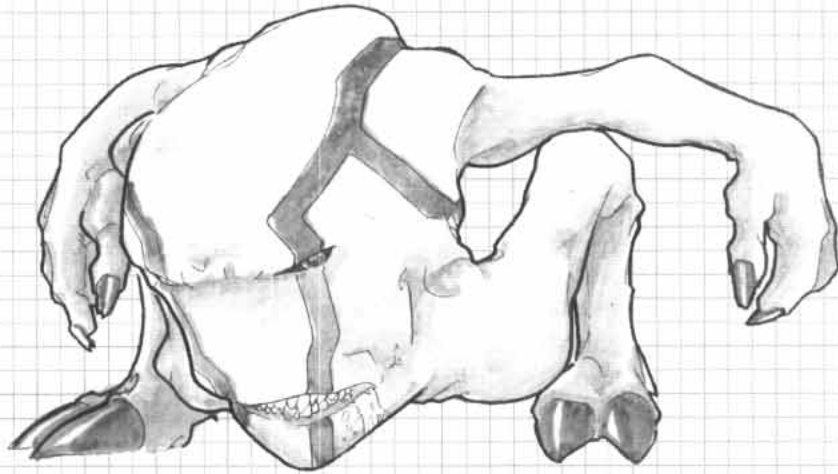

• Description

Vicious carnivores that they are, happening upon a pack of Junkos is not a pleasant experience. Famously mean-tempered creatures, and very territorial, Junkos will attack on sight, even creatures two or three times their size. Almost always traveling in groups of 5 to 15 or more, they try to encircle their prey before closing in for the kill. With their powerful legs they can jump tremendous heights, allowing Junkos to attack the head of humanoid creatures or taller while others jaw at the victim's feet. Because their senses are not particularly strong, it is possible for one to detect a group of Junkos before being detected by them and take measures to avoid confrontation. Once discovered, however, there is virtually no escape, and one best be prepared to fight. They are not particularly intelligent creatures, and some adventurous types have claimed to escape from a pack of Junkos by confusing them, though it is not clear how this would be done.

As an individual, a Junko is not an imposing figure, but rather looks like a short, squat, and slightly overgrown bulldog crossed with an

ape. Even in those rare circumstances that one finds a Junko alone, however, it is still quite capable of causing damage. A Junko can run quite fast, and use its flat broad head as a battering ram. In groups a few will often try this while the prey is distracted by other Junkos using their jump attack. The combination of these two attacks is generally enough to cause even the sturdiest of adventurers to lose their balance, and once on the ground, the Junkos will use their teeth and claws to rip the unfortunate prey right apart. Their jaws are extremely powerful, able to cut through all but the toughest of body armors, and they have the ability to rotate themselves incredibly quickly in a kind of spin attack. While spinning they extend their arms and use their razor sharp claws to cut and slice. Fortunately they can only sustain this for a short duration, after which they are temporarily disoriented. This type of attack is especially common if a lone Junko is ever encountered.

• **Domesticated Junko**

While the Junko is an ill-tempered creature, some of them can be tamed using extreme amounts of patience and efforts. This requires a veteran trainer or someone with extremely high willpower, as well as a lengthy period of acclimatation. Much of the training process is aimed not at breaking the creature's spirit, but at forcing it to accept the trainer as its new pack leader and principal supplier of food.

Domesticated Junko are viewed with suspicion by their wild counterparts and can almost never rejoin a pack. Once the Junko has been broken in, however, it becomes an exceptionally faithful sidekick that will follow and protect its master throughout their travels. Should the master die or abandon the domesticated Junko, the creature will attempt to find a new master — often the very person that eliminated its previous owner, since it has shown proper strength and cunning. If rejected, it will move off and engage in one of two behaviors: either it will shadow its new yet reluctant owner until accepted, or it will wander until it meets a suitable new owner (who may be quite surprised by the acquisition).

Once trained, the Junko will recognise simple commands and most forms of body languages. The creature isn't quite smart enough to engage in complicated maneuvers or plans, though some individuals of note have shown considerable smarts. Domesticated Junko tend to be shunned by people, and local laws may restrict their activities. Unfortunately for all, Junko have a great dislike for leashes and restraints.

• **SilCORE Stat Block**

Attributes: AGI +4, BLD -1, FIT +3, INS +1, PER -2, WIL 0

Secondary Attributes: STR+1, HEA +1, STA 27, UD 5

Skills: Combat Sense 2/1, Defense 2/1, Hand-to-Hand 2/1

Movement: 20m/round, Jump 40m

Special Abilities: Slam (DMx10), Bite (DMx12), Armor Rating 5

• **OGL Stat Block**

Scent (Ex): This ability allows a Junko to detect approaching enemies, sniff out hidden foes, and track by sense of smell.

Junko: CR 2; Medium Beast; HD 5d6+6; hp 21; Mas 17; Init +4; Spd 30 ft., jump 60 ft.; Defense 22, touch 14, flat-footed 18 (+4 Dex, +8 natural); BAB 5; Grap 6; Atk +5 melee (2d4+1 rake); Full Atk +7 melee (1d6+5, 2 claws/rake) and +2 melee (2d6+2, bite); FS 5 ft. by 5 ft.; Reach 5 ft.; SQ low-light vision, scent; AL none; SV Fort +5, Ref +10, Will +1; AP 0; Rep +0; Str 12, Dex 19, Con 17, Int 2, Wis 6, Cha 5.

Skills: Climb +18, Listen +6, Spot +6.

Feats: None.

Advancement: 5-8 HD (Large).

• Jirugui

CHAPTER 3

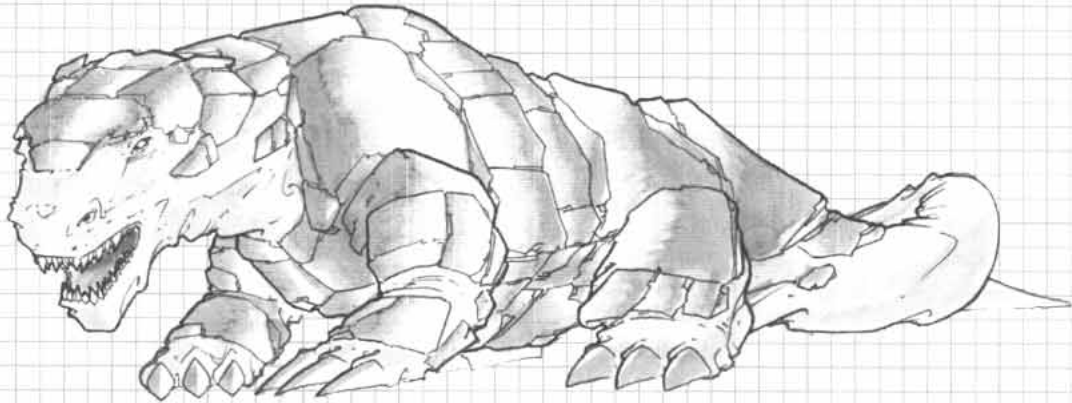

• Description

The Jirugui is a huge battle lizard that is tamed and used as a battle mount and beast of burden on the desert moon of Ima Prime. It is twenty feet long and ten feet high, with heavy armored carapace on its sides, chest and head areas. The eyes are very, very small and pupil-less.

The Insect-Ursinoid tribesmen of the fourth moon of Ima Prime have used the Jirugui as both a means of transport and a weapon of war for over seventy millennia. A hardy but ultimately primitive and violent planet, the Ima home world is a landscape of harsh deserts, rocky outcrops and the very occasional and carefully guarded water sources. What little life does prosper on this moon must demonstrate a high degree of territorial ferocity in order to survive. The K'atheireq tribesmen in their early history competed with the Jirugui for the limited water and food supplies often found therein, with violent and devastating results. Over time, the K'atheireq realized the Jirugui's potential as both a reliable source of muscles for domestic tasks and aggressiveness in combat.

The first recorded attempt at Jirugui domestication was carried out by leading caste

members of the K'atheireq and was a disaster. Very powerful and stable when standing on firm ground, these K'atheireq found out they were devoid of stable anchors when mounting a Jirugui. Following the death of their most esteemed hero under a madly trashing Jirugui, the warrior caste wisely chose to relinquish the task of the beast's domestication to the expendable servile caste of desert herders. To the surprise of all and the jubilation of the first desert herder scapegoat thrown on a Jirugui back, the proud and mean-tempered desert lizard subdued to its new rider. The exploit was later attributed to the long proboscis used by desert herders to collect sap from desert plant and exapted for pressuring the Jirugui at the bottom of the neck, where a victor usually seizes its vanquished opponent in fights in the wild.

Jirugui domestication forced a revolution on Ima Prime, with the desert herders emerging as the new leading caste. These new K'atheireq warriors developed a highly ritualized and acrobatic form of mounted battle whose trappings and ceremonial acts serve as a reminder of the days of the desert herder's emancipation. To a human CORE outsider, the sport bears an uncanny resemblance to the ancient art of jousting.



In the wild, Jiruguis are gregarious animals and can typically be found living in packs of ten to twelve. Their courtship sessions and mating follow a complicated biorhythm. Males and females intermingle freely as long as the multiple suns of the solar system are high in the sky. However, when only the fourth sun, Blue Rhaidon, is shining bright, the Jirugui adopt territorial attitudes and mating challenges resound in the lunar night. These are issued by females as well as males with battles sometimes seen between opposite sexes. Other creatures of Ima Prime, including K'atheireq have learned to lay low on those special occasions.

Lone Jirugui can be encountered, typically as exiled members of a pack or domesticated specimens released by the K'atheireq. Jirugui attack by biting with their enormous tri-line toothed jaws and with their powerful fore claws. The creature has been known to rear on its hind legs, lashing out with the attached bladed claws with a combined nasty bite over its shoulder, but will only resort to such an acrobatic maneuver if sufficiently threatened or presented with a significantly sized opponent (such as another Jirugui). When riding by K'atheireq, Jiruguis are compliant creatures that can move in precise combat formations. Driven by the intelligent minds of their masters, they become truly formidable opponents able to take much larger creatures or large forces. K'atheireq make full use of the acrobatic prowess of their mounts to attack from unlikely locations, springing down steep gorges or bounding over large boulders.

Jirugui carapace hides are highly prized by both the K'atheireq and galactic curio collectors alike and are typically fashioned into wearable armor, weapons and other primitive tools.

• **SiICORE Stat Block**

Attributes: AGI+1, BLD +10, FIT +4, INS +1, PER +1, WIL +1

Secondary Attributes: STR +7, HEA +2, STA 85, UD 22

Mount Quality: -3 (wild) to +1 (battle mount).

Skills: Combat Sense 2/1, Hand to Hand 2/1, Defense 1/1

Special Abilities: Bite (DMx25), Claws (DMx22), Armor 20

• **OGL Stat Block**

Jirugui: CR 3; Large Animal (Reptile); HD 15d6+30; hp 75; MAS: 21; Init +1 (+2 Dex); Spd 40 ft.; Defense 21, touch 10, flat-footed 19 (-2 size, +2 Dex, +12 natural); BAB 11; Grap 21; Atk: +11 Melee (7d4+10, bite); +7 Melee (3d4+10, 2 claws); FS 15ft. by 10ft.; Reach 10ft.; SQ scent (may track using scent); AL Ferocious (N) SV Fort +11, Ref +7, Will -1; AP 0; Rep +0; Str 22, Dex 15, Con 21, Int 2, Wis 2, Cha 8

Skills: Listen +9, Spot Hidden +9

• Khorai Wolf

CHAPTER 3

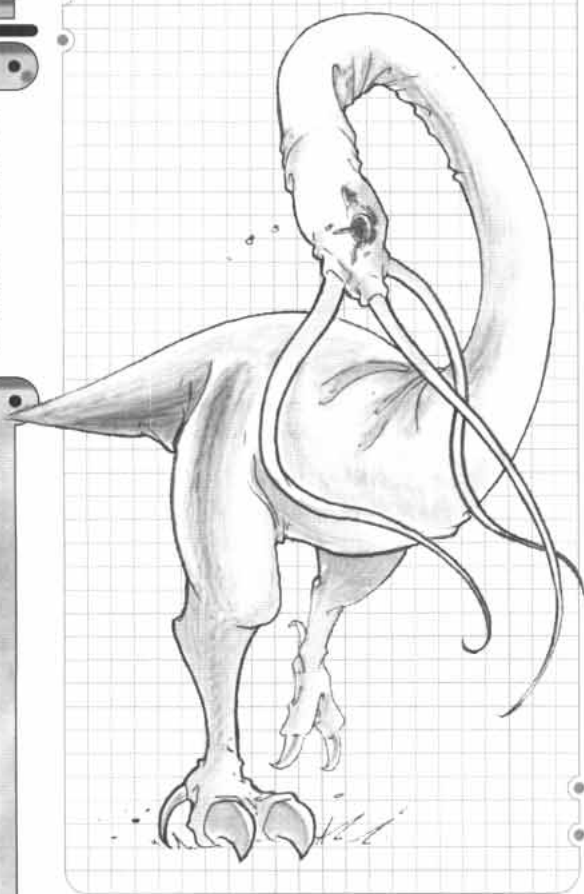

• Description

Explorers in the Khal'tha wastes of Sk'ren III first discovered these voracious, cunning pack creatures some four hundred years back. The evidence of their encounter was recovered on a visual recording device later found on the bodies.

The Khorai Wolves on Sk'ren fill a pack carnivore niche, traveling in packs between six and twelve members when on the prowl for prey. Their typical preys, the Koqius, are large insectoid herbivores devoid of intelligence whose main armament against the Khorai Wolves is a multi-layered carapace evolved to protect them from slashing blows.

The Khorai Wolves have in turn adapted in this evolutionary arms race. Over numerous eons, they have developed the ability to squirt mighty gouts of a chemical cocktail with corrosive basic properties (a chemical antagonist of acid; similar in terms of game mechanics). These expectorate specifically react with the Koqiu armor, breaking down the polymeric molecular chains found within and effectively dissolving the scaly plates off the Koqiu's back. The beast then moves in for the kill, jumping on the prey and slashing it down to a residual sludge with its razor sharp taloned hind legs. Its three tentacle trunks are little more than muscled openings without any teeth or ability to chew which the Khorai Wolf utilizes principally to suck Koqiu carcasses dry or reach down in small crevices where most of the water found on the Khal'tha wastes collects.

On Sk'ren, the Khorai Wolves live on the barren stretches of the Khal'tha wastes, a dry husk of a land that rarely receives more than five centimeters of precipitation per earthly year. This does not bother the Khorai Wolves, however, as they are very well adapted to this land and know no other type of existence. The Khorai Wolves do not sweat and their scaly hides are covered with a thin film of web-like feathers designed to prevent the escape of what little humidity they expose to the arid air. Their tentacles are highly vascularized and designed to dissipate much heat and no water to the external environment. In days of sweltering heat these tentacles become gorged with blood and are periodically spread open by their owners for fanning and to free large measures of internal heat. A group of fanning Khorai Wolves, when observed from afar, resembles a field of blooming flowers moving in slow circles. Those who have observed the phenomena and lived to tell the tale refer to it as the 'Dance of the water lily'.

The Khorai Wolves are like most other animals found in nature and normally do not attack other life forms unless irrevocably threatened or driven by hunger. It must be said, however, that Khorai Wolves live in a mostly barren and



lifeless environment which primes them to feel threatened very easily. A pack of Khorai Wolves on the hunt is a frightening sight. They keep their body bent near the ground when running, which, combined with their scales colored to resemble the charred dust of the Khal'tha wastes, allows them to elude the searching eye of wary prey. They are also endowed with an evolutionary advantage stemming from their unique language connate to the ever-present winds on Sk'ren. A small organ right behind their spitting orifice allows them to trap and modulate the wind to low-pitched crescendos and rapid screeching staccatos. Unfortunately for their quarries on Sk'ren, this language is almost undistinguishable from the usual wail of the wind.

Creatures very similar to the Khorai are not common but can be found on several dozen worlds throughout the five galaxies. The environment is almost always of the arid inhospitable one as it seems that the Khorai Wolf ectomorph is an evolutionarily winning adaptation to a life under these conditions.

• **SilCORE Stat Block**

Attributes: AGI+1, BLD +0, FIT +2, INS +1, PER+1, WIL +0

Secondary Attributes: STR +1, HEA +1, STA 30, UD 5

Skills: Combat Sense 2/2, Defense 2/1, Hand-to-Hand 2/1, Small Arms (Projectile Spray) 2/2

Special Abilities:

Base Spray: Able to spray an area of effect cone, 10 meters by 3 meters, at an opponent. Treat as a ranged attack with +1 to the attack if the target is moving, or target must anticipate the attack and move out of the area of effect, otherwise the base compound inflicts an Intensity 10 chemical burn/fire.

Base Immunity: The Khorai are almost entirely immune to reactions with most base chemicals, and immune to the effects of their own and other Khorai sprays.

• **OGL Stat Block**

Base Spray: can spray an area of effect cone with a strong, extremely harmful chloride (base) that is 30 foot long and 10 foot wide at its end. Acid from the creature does 5D6 damage, and it may use spray it every third round of combat.

Base immunity: Khorai is immune to most bases, including spray from other Khorai.

Khorai Wolf: CR 4; Medium Animal; HD 9d4+17; hp 35; Mas 17; Init +6 (+2 Dex, +4 Improved initiative); Spd 60 ft.; Defense 17, touch 13, flat-footed 14 (+2 Dex, +5 natural); BAB 6; Grap 8; Atk +6 Melee (2d6+2, 2 hind claws rake); FS 5ft. by 5ft.; Reach 5ft.; SQ base spray, base immunity; AL none; SV Fort +6, Ref +8, Will +3; AP 0; Rep 0; Str 15, Dex 16, Con 17, Int 2, Wil 9, Cha 6.

Skills: Listen +4, Spot +4

Feats: Alertness, Improved initiative.

Advancement: Small (3-4 HD)

• Mnemonic Keeper

CHAPTER 3



• Description

The beings that would later be called the Mnemonic Keepers were first encountered by an expedition to the Deltoan sub-sector, within the eastern part of the Spiral galaxy. The explorers were trying to make contact with a Dreamstate civilization that had been rumored to exist within a small cluster of star systems, though no probe had ever located any installation beyond ruins.

The Mnemonic Keeper is a large, monstrous looking creature that stands far taller than a man. It's covered with a thick skin and plates of natural armor, and large muscles can propel it at a fearsome pace. A thin but very sturdy sting emerges from just above the mouth; specialized glands generate a highly reactive organic substance that acts as a neural poison, and is also flammable. If need be, the creature

can squirt vast amount of this compound, igniting it with sparks from a set of exposed metallic bones within the mouth itself. A tough digestive system allows it to gain sustenance for virtually organic material, not matter its form and biochemistry. Such a powerful and versatile creature could hardly have evolved naturally, and indeed samples of its cells (hastily gathered from the expedition's survivors' wounds) showed proof of extremely complex and ancient genetic engineering.

What earns the Keeper its name are the multitude of imbedded datanodes that are scattered over its head and upper back. Each node is linked to its neighbors by a dedicated bundle of nerve cords. Some of the nodes, especially around the head, radiate feebly in the lower EM spectrum, and might be used either to communicate with other Keeper or to

backup data. In effect, the whole network is a very powerful distributed computing system. The current theory goes that it holds the digitized consciousness of the beings who engineered the creature in the first place. They may have abhorred technology or relied exclusively on biological sciences, or perhaps they just felt safer with mobile databanks that could defend themselves. No one knows which of these explanations hold true.

This has two interesting applications, a new civilization to talk to (provided there is a way to communicate with the being or community housed within each Keeper) and very advanced bio-computing applications and technology. The problem, of course, is finding a way to either subdue the aggressive Keeper or link to it. This also assumes that its masters want to talk to outsiders, and will not just consider this an invasion that needs to be met with brutal force.

• **SiLCORE Stat Block**

Attributes: AGI -1, BLD +5, FIT +3, INS +2, PER +1, WIL 0

Secondary Attributes: STR+4, HEA +2, STA 60, UD 14

Skills: Combat Sense 2+1, Dodge 2/-1, Hand-to-Hand 2/-1. Small Arms (breath weapon) 2/-1

Movement: 40m/round

Special Abilities: Slam (DMx20), Bite (DMx30), Breath Attack (ACC 0, DM x50, BR 10m, ROF 0/4, Incendiary, Wide-Angle (10)), Poison Sting (Onset 0 sec., Potency 6), Immune to electrical attacks, Armor Rating 50

• **OGL Stat Block**

Breath Weapon (Su): Can breathe a 60-foot-long, 5-foot-wide line of fire every 1d4 rounds as an attack action. Any creature in the line of fire takes 5d10 points of damage, or half damage if a Reflex save (DC 25) succeeds.

Improved Grab (Ex): To use this ability, a Keeper must hit with both claw attacks. If it gets a hold, it hangs on and stings. If a Keeper grabs a creature two or more size categories smaller, it automatically deals damage with both claws and its sting each round the hold is maintained.

Poison (Ex): A creature stung by a Keeper must succeed a Fortitude save (DC 25) or take 2d6 points of temporary Con damage. After 1 minute has elapsed, the creature must succeed on a second save (DC 25) or take another 2d6 points of temporary Con damage.

Scent (Ex): This ability allows a Keeper to detect approaching enemies, sniff out hidden foes, and track by sense of smell.

Immunities (Ex): Keepers are immune to sleep, hold, and paralysis effects.

Skill Bonus: Keepers receive a +3 species bonus on Spot checks during daylight hours.

Keeper (Adult): CR 16; Huge Aberration; HD 19d12+114; hp 237; Mas 23; Init -2; Spd 40 ft.; Defense 21, touch 6, flat-footed 21 (-2 size, -2 Dex, +15 natural); BAB +19; Grap +37; Atk +28 melee (1d8+10 plus poison, sting); Full Atk +28 melee (1d8+10 plus poison, sting), +26 melee (2d8+5, bite), +26 melee (2d6+5, 2 claws); FS 15 ft. by 15 ft.; Reach 10 ft.; SQ breath weapon, improved grab, fling, poison, scent, immunities, darkvision 60 ft.; AL neutral; SV Fort +17, Ref +9, Will +12; AP 0; Rep +0; Str 31, Dex 7, Con 23, Int 6, Wis 12, Cha 10.

Skills: Listen +22, Move Silently +17, Search +17, Spot +22 (+25 during daylight).

Feats: Alertness, Cleave (bite), Multiattack, Power Attack, Weapon Focus (sting).

Advancement: 20-26 HD (Huge);

• Sacnoth 5736

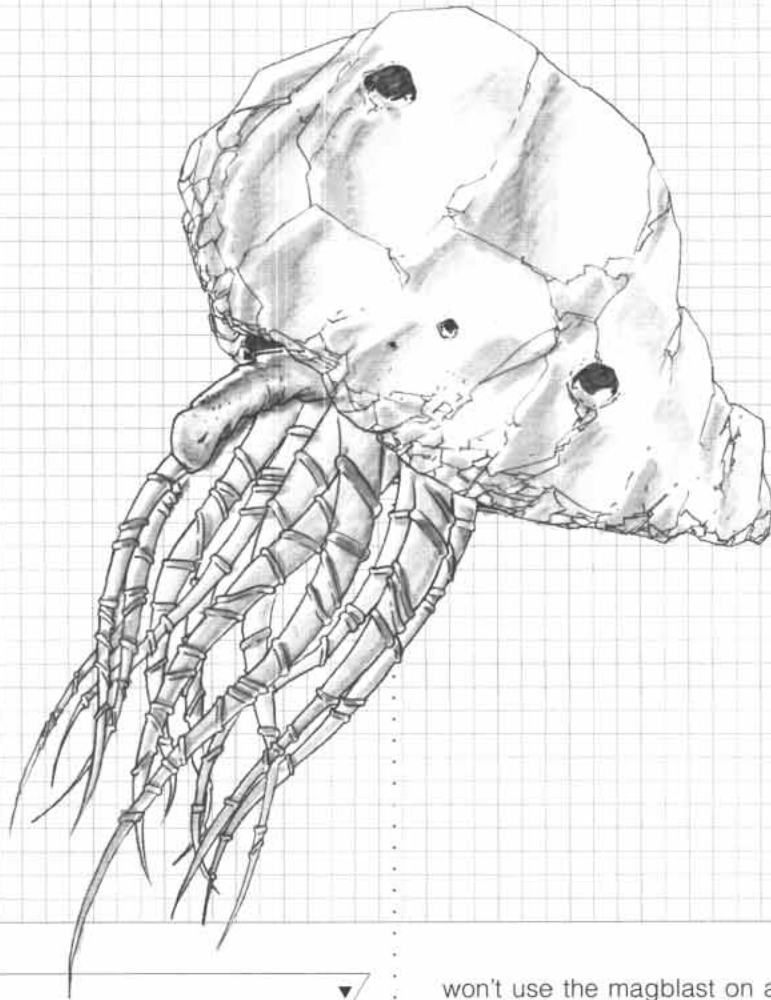

• Description

Sacnoth 5736 is a singular creature that lives in the stellar nebulae of the same name. Roughly as large as a medium-sized asteroid, this massive but stupid squid-like creature is capable of manipulating the complex magnetic fields of the nebula for propulsion and attack. It also seems to have some sort of rudimentary gravity sense, as it can detect the presence of a ship's drive from millions of kilometers away. A ship's drive field enrages it, however, and will prompt it to attack. If a ship turns off its drive, but radiates any sort of heat, it will attract a different sort of attention from Sacnoth. The creature will attempt to mate with the ship, which is tantamount to an attack, though it

won't use the magblast on a potential mate. The fact that Sacnoth exhibits mating behavior suggests there is, or at one time was, one or more similar creatures. Where they might be or what might have happened to them is anyone's guess, with several fables and myths based upon the subject.

Sacnoth's lair is an asteroid covered with the wrecks of spacecraft, some of them incredibly ancient. Anything could be hidden in the wreckage. CORE scientists, in addition to learning more about Sacnoth, long to examine this debris as a historical record of space travel. Such a mission has been proposed numerous times but is never approved due to the remote chance of surviving such a close

encounter with Sacnoth. Rumors do persist that the surface of Sacnoth's lair is home to a society of rouges and criminals, though there is no evidence to suggest this is true. This rumor germinates from the well known fact that spacecraft navigated by the truly desperate will travel towards Sacnoth purposefully to avoid pursuit.

There is no record of any ship surviving an encounter with Sacnoth, and it is unknown how many near misses occur, since by the time a ship detects Sacnoth, it is too late. Most crews will go out of their way to avoid the sector, but there are also rumors of covert military operations in the area, using the fear of Sacnoth as cover to deter observation. Unlike the other rumors and stories about Sacnoth, these ones have a better than average probability of being true.

• **SilCORE Stat Block**

Attributes: AGI +1, BLD +20, FIT +5, INS +3, PER +0, WIL +0

Secondary Attributes: STR +12, HEA +2, STA 135, UD 38

Skills: Notice 2/1, Combat Sense 2/1, Defense 2/1, Hand-to-Hand 2/1, Small Arms (Magblast) 2/1

Movement: 1000m/round (space only)

Special Abilities: 8 x Arms (DM x30), 2 x Long Tentacles (DM x80 + haywire), Mag Blast (Acc. 0, DM x250, BR 100m, ROF 0, Haywire), Armor Rating 50

• **OGL Stat Block**

Improved Grab (Ex): To use this ability, Sacnoth must hit an opponent of up to Huge size with an arm or tentacle attack. If it gets a hold, it can constrict. constrict 2d8+12 or 1d6+6

Constrict (Ex): Sacnoth deals automatic arm or tentacle damage with a successful grapple check against Huge or smaller creatures.

Mag jet (Ex): Sacnoth can jet backward once per round as a double move action, at a speed of 1000 meters.

Mag Blast: 10d6 damage, range 200 meters.

Sacnoth 5736: CR 10; Colossal Beast (Vacuum); HD 30d10+350; hp 650; Mas 36; Init -8 (Improved Initiative); Spd 0-G 200 ft.; Defense 32, touch -5, flat-footed 32 (-10 size, -5 dex, +37 natural); BAB 30; Grap 68; Atk +30 Melee (2d6+38, 10 tentacle rake), +30 Melee (10d12+38, bite); FS 90 ft. by 90 ft.; Reach 100 ft. with tentacle; SQ magnetic move, mag blast, improved grab; AL none; SV Fort +34, Ref -5, Will -2; AP 0; Rep 0; Str 54, Dex 2, Con 36, Int 5, Wis 3, Cha 3.

Skills: Knowledge (Sacnoth Nebula) +10, Search +15, Spot +15.

Feats: Alertness, Blind-Fight, Expertise, Improved Critical_(tentacle), Improved Initiative, Improved Trip, Iron Will.

Advancement: 21-32 HD (Gargantuan); 33-60 HD (Colossal).

Climate/Terrain: Sacnoth Nebula.

Organization: Solitary.

Treasure: In its lair, there could be ships, weapons, practically anything.

• Silverspine

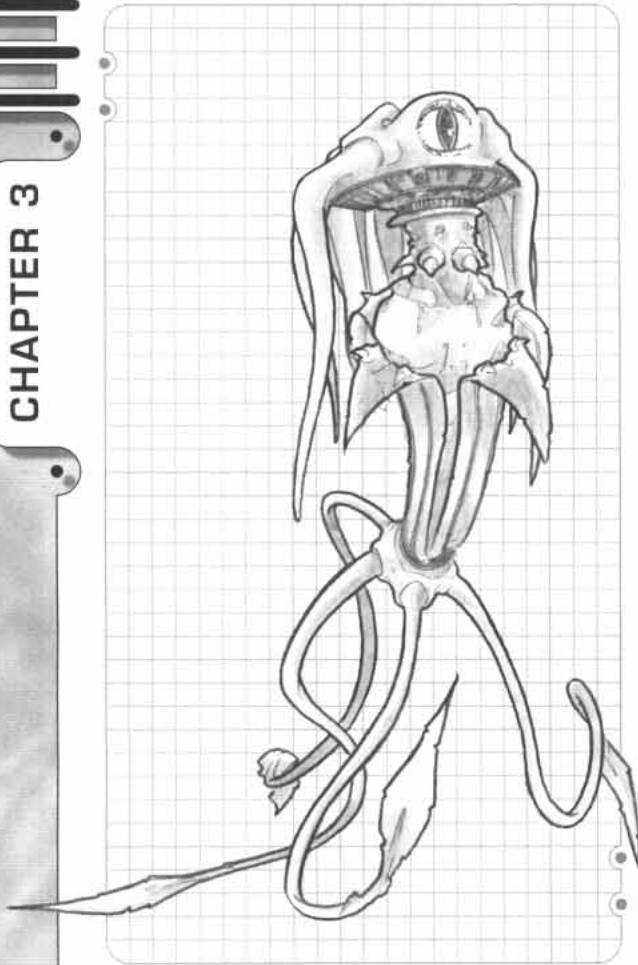

• Description

There exist few words that could faithfully describe a Silverspine as well as 'alien'. These creatures are like walking plant stalks only they mount an octopus like head with dangling ropey tentacles. They do not walk but seem to float on three to five vine cords that protrude from the bottom of their body, each with a claw-like sharp hardened leaf on their end. Most Silverspines stand about the height of a human, but the species shows a lot of size and proportion variations. Silverspines towering 15 feet tall are occasionally found. Silverspines are omnivorous quasi-plant creatures. By account of their diet they are clearly considered to belong to the animal kingdom.

Yet, they are mostly made of cellulose fibers and exhibit extensive photosynthesis. Furthermore, while they are capable of directed daytime movement, at night they take root in soil to rest. While doing so they are able to regenerate themselves the same way a plant would regenerate damaged leaves and stems.

The first Silverspines were collected as seeds on a tropical planet, named UU-98MCCXXXII in CORE's databank, in the Trianguli galaxy and stored for many years before being grown. Lengthy experiments came to the conclusion they would only grow when affixed to laboratory walls. The first specimen opened an eye that gazed intelligently at the researchers present. Whether or not the Silverspine is truly intelligent is not known due to the absence of any means of communication with the creature. For centuries now, the Silverspines have been grown and thrice studied for the two venoms they produce, their regenerative properties and their peculiar mean of transportation. The venom's chemical compositions are very easily modified, allowing researchers to turn these into either one of a large array of useful drugs. The mystery underlying their transportation method was rapidly elucidated; researchers having found out their 'legs' had a molecular structure akin to carbon nanotubes, a single limb easily lifting the creatures five times. In contrast, the restorative properties of Silverspine pluripotent cells have not successfully been harnessed for humanitarian purposes. Researchers are still frustrated as to how a single damaged cell from a Silverspine has the property to regenerate entire individuals.

Silverspines, in turn, have been able to migrate across their native galaxy and beyond through the interim of spaceships. They have colonized many wild but hospitable planets. Baffling most educated guesses, they have demonstrated unprecedented resilience in colonizing new worlds, adapting to temperate, boreal and even some more exotic climates. Perhaps this is due to their accommodating palate, as a Silverspine will eat almost anything. Unfortunately, in the case of larger specimens, this includes humanoids, earning the species

the classification of 'threat' by CORE. As Silverspines were first found as seeds, it was postulated they reproduce sexually. However, such an event has never been directly observed to date and almost all Silverspines found on different planets are clones of the original specimen recovered from UU-98MCCXXXII. Silverspines are believed to be solitary creatures devoid of language but the mounting number of red herrings and misleading conclusions pertaining to the alien leads some CORE researchers to claim there must now exist a Silverspine civilization somewhere.

Silverspine hunting techniques are also unlike most of what is found elsewhere. Silverspines are equally comfortable scaling perfectly smooth vertical surfaces as horizontal ground and will climb to a vantage point to await a prey. Once in a desired position, the creature can assume almost any orientation, favoring the posture most suitable to blend in with the surrounding vegetation. They snag the first incoming prey by wiping their lower vines at them with the intent of scoring a hit with the end barb. This barb contains the first venom, which acts as a fast-acting, pain inhibiting paralyzing agent. The Silverspine uses several smaller tentacles protruding from its head to administer the second venom to paralyzed victims. This is really a secretion of mutualistic fungal agents, which slowly decay the victim into a biological mush that the Silverspine can consume.

Smaller Silverspines will sometimes simply walk up to unsuspecting parties, extending out a vine in an eerie imitation of a greeting to simply poke a hole at any unfrightened living being. Debates still rage as to whether this is a proof of Silverspine intelligence.

• **SilCORE Stat Block**

Attributes: AGI +0, BLD +0, FIT +0, INS -5, PER +0, WIL +0

Secondary Attributes: STR +0, HEA +0, STA 25, UD 3

Skills: Athletics (Climb) 2/3, Combat Sense 2/1, Defense 2/1, Hand-to-Hand 2/1

Movement: 10m/round in any direction

Special Abilities: Poison (Analgesic, Onset Time 0 sec., Potency 10), Armor Rating 5

• **OGL Stat Block**

Silverspine: CR 2; Medium Plant; HD 4d8+8; hp 24; Mas 5; Init +2; Spd 30 ft., climb 30 ft.; Defense 14, touch 11, flat-footed 12 (-1 size, +2 Dex, +3 natural); BAB +3; Grap +12; Atk +7 melee (1d6+5, claw); FS 5 ft. by 5 ft.; Reach 5 ft.; SQ low-light vision, scent; AL none; SV Fort +6, Ref +6, Will +2; AP 0; Rep +0; Str 10, Dex 15, Con 5, Int 2, Wis 12, Cha 7.

Skills: Climb +18, Spot +6.

Feats: None.

Advancement: 5-8 HD (Large).

• Tra

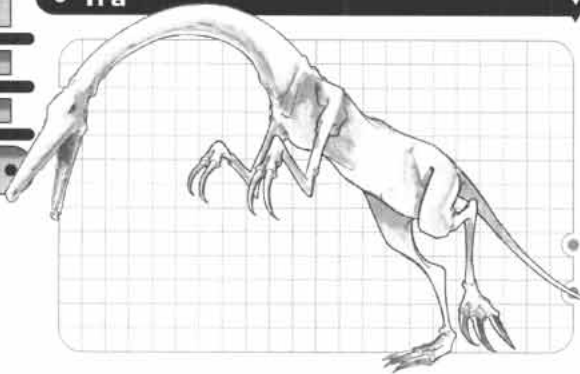

CHAPTER 3

• Description

Tra are small reptilian vermin, known for their voracious appetite and willingness to eat almost anything. As omnivores they will eat plant and animal matter, necessary as scavenging is their primary method of obtaining food. Tra found in the wilderness tend to be very lean and quick. When hungry enough, they have been known to bring down live prey of their own, though this is less common.

True pests, Tra feed on waste and anything else they can get their claws on. They have spread from world to world by stowing away on spacecraft. Infestations are all too common in the poorer areas of many colonies and anywhere large stores of food are kept. They are also known for eating through plastics and wiring, which while usually only a nuisance, can sometimes have dire consequences.

They are usually timid when encountered singly, be it in the wild or in a settlement and would much prefer to flee rather than fight. They are good climbers, and equally adept at hiding in city or wilderness environments. More often they are encountered in swarms of varying sizes, depending on the availability of food in the area. In the wild, groups of two to ten are most common, while in settlements nests with 50 or more inside have been found.

Given an abundance of food, females will breed virtually non-stop, with food brought to them by foraging males. The better and more plentiful food brought, the more likely the female will mate with the particular male. In clinical studies females seem to breed indefinitely, only limited by food supply. Thus it is believed that after reaching a certain size, infighting and competition causes a group to break off and find a new nesting area. While this limits the number found in any one nesting site despite the constant reproduction drive, where conditions permit multiple nests may be in close proximity to each other.

One particular case was recorded of numerous nests with in excess of a thousand individuals combined. In contrast with an individual, these swarms can be aggressively territorial, and are especially ferocious when intruders disturb their nests. They attack with claws and teeth in a relentless fashion.

• SiICORE Stat Block

Swarm Stats: Aggressiveness 3, Damage/Round 4, Damage Threshold 25, Random Horde 1D6, Swarm Size 10

• OGL Stat Block

Tra: CR 1/8; Tiny Animal; HD 1/4 d8; hp 2; Mas 10; Init +2 (Dex); Spd Spd 15 ft; Defense 14 (+2 size, +2 Dex); BAB 0; Grap 13; Atk +4 Melee (1D3-4, Bite); FS 2.5ft by 2.5ft; Reach 2ft; SQ scent; AL none; SV Fort +2, Ref +4, Wil +1; AP 0; Rep 0; Wil +1; Str 2, Dex 15, Con 10, Int 2, Wis 12, Cha 2.

Skills: Balance +10, Climb +12, Hide +18, Move Silently +10.

Feats: Weapon Finesse (bite).

Advancement: None

• **Keepichai**

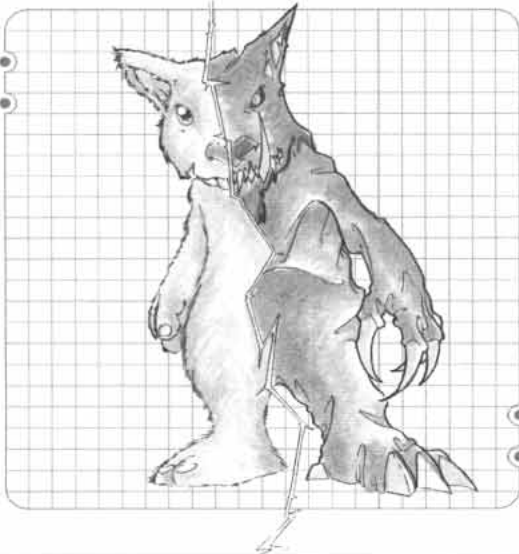

• **Description**

"The sign of the Rabbit is an omen of great luck and good fortune. The rabbit is a pleasant person, charming, and always of good company. No harm will come to you on the night where you hug a rabbit before going to sleep." — Long forgotten Chinese Horoscope

The nightmare that seeps into one's dreams; the feeling of dread that taints a home with an air of doom; the very gloom that clings to the air; the Keepichai is the proverbial monster in the closet. They were once the companions of the Proteans, the polymorphic jack-of-all-trades of the five galaxies. With their masters, they shared the gentleness, the intelligence and the ability to morph, or change their external appearance to suit their whims. The Keepichai shared a relationship of equal standing with the Proteans, holding different positions in their society and even seats on their government. They were often sent by the Protean-Muran alliance as scouts to chart unexplored locations on newly discovered planets.

Over a full decade in the recent past, however, disaster struck the Keepichai specie. A lone Keepichai returned home bearing a recombinant virus that spread like wildfire in the entire race, mutating and warping their physical appearance and mental persona into a terrible mockery of their former self. Their shapechanging abilities

were replaced by a more insidious power. This they used at first to impersonate what they once were by projecting an image of harmlessness in their victim's mind. They lured and murdered scores of Proteans that way before being uncovered and banished by their compassionate former allies.

Today they haunt the most lonely and desperate holes in the galaxy, still following their former ploy of appearing cute and innocent to trap the unwary. Some rare Keepichai have developed further mental powers and are now able to influence outsider's minds in other ways. Their cries sometimes echo in the emptiness of their lairs, though if that reflects their hatred or their suffering no one could tell.

• **SILCORE Game Mechanics**

Attributes: AGI +2, BLD -3, FIT +1, INS +3, PER +1, WIL +0

Sec. Attributes: STR -1, HEA +0, STA 10, UD 1
40m/round movement

Skills: Combat Sense 2/+1, Dodge 2/+2, Hand-to-Hand 2/+2.

Special Abilities: Disguise (PER Threshold 5 to penetrate disguise), Claws (DM x3), Teeth (DM x4), Armor Rating 3

• **OGL Game Mechanics**

Keepichai: CR 1; Tiny Animal; HD 1/2d8; hp 2; Mas 10; Init +2 (Dex); Spd 30 ft.; Defense 14 (+2 size, +2 Dex); BAB 2; Grap 2; Atk +4 Melee (1d2-4, 2 Claw), -1 Melee (1d3-4, Bite); FS 2 1/2 ft. by 2 1/2 ft.; Reach 0 ft.; SQ psionic disguise; AL none; SV Fort +2, Ref +4, Will +1; AP 0; Rep 0; Str 3, Dex 15, Con 10, Int 3, Wis 12, Cha 7.

Skills: Balance +10, Climb +5, Hide +17, Spot +4.

Feats: Weapons Finesse (Claws).

Advancement: 2-3 HD (Small).

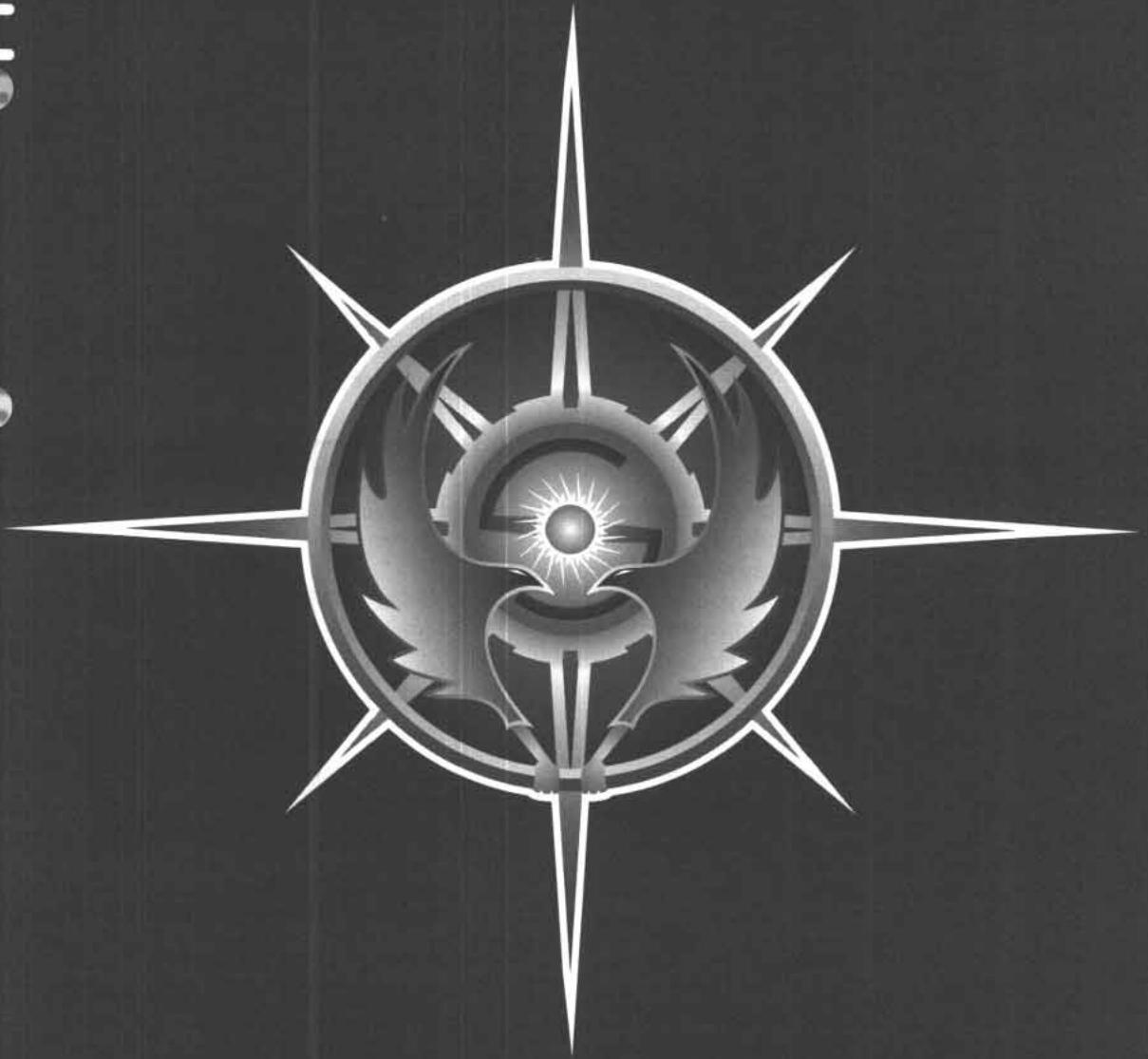

CHAPTER 4:
Artifacts & Constructs

• Mechanical Beings

Most advanced humanoid societies have recognized the parallel between the electrical currents produced by their technology and the similar impulses of their nervous system. In its simplest form the analogous nature of both humanoid nerves and electronic systems has led to the successful implementation of mentally controlled artificial limbs. At the same time genetic engineering technology allows for the manipulation of biological organisms by more 'natural' means. Throughout the universe these advanced technologies are being developed and can be found put to use to a varying degree. Non-humanoid species, with their own unique physiologies, are busy exploring this realm of possibility as well. While many stunning advancements are being made, CORE is by no means the leader in this regard, as the remarkable (even if remarkably terrifying) constructs of the D'vor provide one example of.

There are a number of mechanical civilizations scattered throughout the Five Galaxies. Many of them are the end results of the evolution of an organic species that underwent dramatic technical progress. This knowledge was used to augment their bodies. Initially such augmentation would involve genetic manipulation in order to improve upon some weakness, such as vulnerability to disease or radiation. As their technical prowess advanced even further, this transformation delved beyond mere genetic manipulation, and allowed them to eventually transcend their original bodies with the actual creation of bio-mechanical creatures, and in some cases, almost purely mechanical beings. Indeed, sometimes the line between organic and inorganic is extremely blurred.

Other bio-mechanical creatures may have been created as-is by highly advanced races. There are many D'vor menaces that fit into this category. The defense mechanisms of most Dreamworlds are also of this nature as well.

• Capabilities

A construct is an animated object or artificially constructed creature. As such, they are immune to many ailments and weaknesses of living beings, such as the need to breathe, eat or sleep (for the most part — some artifacts, such as many D'vor creatures, do require atmospheric gases to function). Most of the time, they are also unaffected by things like poison or stunning blows. Constructs don't feel fatigue or get bored, and this makes them well-suited for extended and monotonous duties, such as patrols. They also adapt to new environments with ease, adjusting to various levels of things like gravity and radiation with a minimal time delay and/or distress that most biological organisms would face.

On the downside, most constructs cannot heal damage on their own and need to be repaired whenever they do get damaged. They may also need regular maintenance and refueling. Some very advanced constructs, mainly artifacts and other creations of powerful civilizations, do have sophisticated self-repair systems incorporated that allow them to replace damaged components over time, given access to the necessary raw material. As well, while many constructs are highly intelligent, only a very few extremely advanced constructs can incorporate new technology that was not part of the original design.

Animators

CHAPTER 4



Description

Animators are hideous little devices designed to transform a fresh intact corpse into a combat drone. On its own, an Animator appears as an ovoid the size of a human fist. When placed on a body and activated, it bores inside and attaches itself to the nervous system, effectively becoming the "brain" of the body. After a few minutes, the corpse rises and can be issued orders.

Animated corpses are deployed as shock troops and front line soldiers, though they have also been used to send troops back into battle as they fall. Most sentient races revile Animators, and even those who use them try to deploy animated troops well away from living units. Animators are not fully sentient, but they are cognizant enough to function independently. Animated bodies are immune to pain and toxins, and no longer breathe. The corpse will continue to decompose, however, and will remain useful for only a few hours, gradually becoming less mobile as rigor mortis sets in.

SiLCORE Stats

The Animator requires d6 minutes to assume command of a fresh corpse. Once animated, the body retains all physical Attributes. Mental Attributes immediately drop (or are raised to) 0. Any Skills or special knowledge possessed by the body while alive are lost. The Animator can be programmed with an equivalent of 20 Skill Points, though these are almost always spent on Combat Skills (Hand-to-Hand, Melee and so on). Rigor mortis robs the body of -1 AGI every two hours. When AGI drops below -5, the body ceases to function. Animators cost 5000 credits and weigh 1 kg.

OGL Stats

Treat animated corpses as appropriately-sized Zombies with these exceptions: animated corpses can be given complex orders and can move and act normally. Such corpses remain active for 3d4 hours after creation before the body enters rigor and becomes useless. While these corpses are statistically exactly the same as undead, they are not undead in the supernatural sense and cannot be affected or influenced as such.

• **Kloopterra**

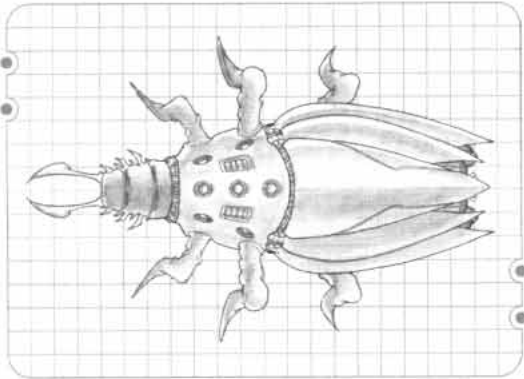

• **Description**

The Kloopterra are an inorganic organism of simple elegance and technological terror. No one knows whether they are a artificial or naturally occurring life form, but the first record of their appearance dates to the destruction of the Cyles VIII ringworld some 200 years ago.

As a swarm, Kloopterra look like a cloud of grayish dust. Individually observed, they are revealed as micro-sized mechanical scarabs, with dull metallic grey bodies, six legs and streamlined mandibles. They swarms over metallic objects, such as ship's engines and control surfaces, and devour them using a combination of acid and sophisticated grinding apparatus.

The Kloopterra live to consume inorganic material, complex metallic compounds in particular. As well as deriving nutrition from this, they also self-replicate — at an alarming rate, too. A Kloopterra infestation is a crisis situation: they have been known to completely destroy artificial stations and starships within a day or more. The mere detected presence of one or more individual Kloopterra is enough to result in an interplanetary blockade until the threat is completely dealt with.

Kloopterra are susceptible to fluctuations in magnetic fields; a non-cyclical rotation of the magnetic charge of an inorganic device, vehicle or installation will hold them at bay, but they must be destroyed to neutralize the threat.

• **OGL Stats**

Klooptera Swarm: CR 3; Large Construct (micro-bot); HD 5D10; hp 25; Init +2 (Dex); Spd 60 ft; AC 15 (-1 size, +4 natural +2 swarm bonus); Atk: special; Face 10 ft by 10 ft; Reach 10 ft; SA destroy inorganics; SQ replication; AL N; SV Fort +3, Ref +7, Will +1; STR 10, DEX 16, CON —, INT 5, WIL 5, CHA —; 10 ft by 10/10ft, 40 lbs.

Special Ability — Replicating Sabotage: The Kloopterra are able to co-occupy existing space with other characters and equipment. Those engulfed in the area (10' by 10) must make an item saving throw versus DC 25 for each item, or the item in question is destroyed. Inorganic characters take 10d6 damage per round of exposure.

Special Qualities — Replication: A swarm may replicate another swarm in one hour. A horde (a swarm of 20 or more) is required to do significant damage to vehicles, with 16,777,216 hordes (unchecked growth for 24 hours) resulting in a mega-horde which can devastate a major space installation or artificial habitat in 24-48 hours or more.

• **SiICORE Stats**

Swarm Attributes: Aggressiveness: 3, Damage/round: 10, Damage Threshold: 30, Random Horde Size: 6D6 (average 20), Swarm Size: 10,000.

Swarm only targets metallic and semi-metallic objects and devices.

Sabotage: Damage of Horde inflicted is in Vehicle Scale per hour. A mega horde is required to inflict the same damage on Gigantic Scale vessels. May target specific systems for critical effects based on initial infection and ship layout.

Replication: A swarm may replicate another swarm in one hour if enough material is available. A horde is required to do Vehicle Scale damage. 16,777,216 hordes (unchecked growth for 24 hours) are required to create a mega-horde. Damage is treated as slow acting Disintegration damage.

• Graviton Spheres

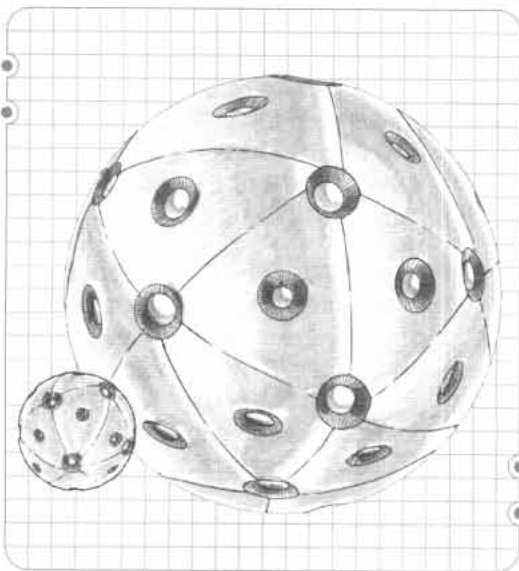

• Description

The Graviton Warden, Sentinel and Guardian are three designs in an integrated interplanetary defense system that uses focused graviton waves for attack, defense and movement. They were designed and deployed by an unknown race through multiple, seemingly random systems across both the Spiral and Andromeda galaxies. No one knows what the Gravitons are protecting or defending against — the only reason CORE knows of them at all are the disastrous encounters with CORE vessels and a subsequent covert investigation.

A Graviton is a sphere with a radius of two meters (Warden), 400 meters (Sentinel) or twelve kilometers (Guardian). All variants taken together, it's assumed they number in the millions, with the smaller units being much more common (a rough ratio of 100-to-1, when moving up one size category, seems to hold).

Sentinels and Guardians are the space-based components of the system. The Guardian acts as a transport (up to 100 Sentinels) and system-wide C3 center in addition to being the major space combat component capable of

taking on even the most powerful vessels known. Sentinels act to intercept and interdict any intruders into the system, and patrol areas of the protected system. Wardens are a planet surface-based system. They appear to be smaller versions of the Sentinel and perform the same function.

• Capabilities

All Graviton spheres are built using the same general layout. The sphere's surface is slightly faceted; the current assumption is that each facet is a graviton field controller that provides the unit with a weapon, defensive shield and propulsion. The surface of the sphere exhibits photo-reactive properties in addition to built-in sensor confusing equipment; this makes a Graviton very hard to detect. The ability to react to a threat while remaining undetected, thanks to its own powerful electronic countermeasures systems, is part of what makes the Gravitons so dangerous.

The spheres are very agile and quick for their respective sizes. Their projected graviton shields can simply deflect any mass or energy directed at them. The graviton weapon is also a marvel of engineering: it's capable of crushing its target under an amplified gravity field, holding it in place, or even slamming it into other objects. Some even theorize that the graviton emitters are capable of very fine manipulations to perform delicate tasks; thus, many believe the Gravitons were also servants and assistants to their creators. How the Gravitons are able to produce all these effects is of great interest to CORE scientists, since graviton technology is generally used only for planetary mobility (a-grav networks) and wave guides for FTL travel.

If these features weren't enough to make a Graviton tough, it also has self-repair capability. The sensor records from a CORE exploratory vessel have logged definite telltale signs of a crippled Sentinel busy repairing itself. And finally, there is evidence that the Gravitons have a high level of intelligence; whether it is organic or inorganic in nature is still a matter of speculation.



CHAPTER FOUR: ARTIFACTS & CONSTRUCTS

• Background

Shortly after the first Gravitons were encountered, a specially equipped CORE reconnaissance vessel was dispatched to investigate the system and the Gravitons that defended it. The team spent a long time playing hide-and-seek with Sentinel and Guardian Gravitons as they collected data with passive sensors and tried to remain undetected. A simultaneously conducted planetary survey revealed that the fourth planet and a moon around the fifth were marginally habitable and seemed to be the focus of Sentinel and Guardian activities. With the survey and passive observations completed,

the team decided to attempt a landing on the moon to see if they could determine what was special about it. The descent was tense, but did not provoke a response from the nearby Gravitons. A number of interesting readings from low altitude led the team to pick a landing site close-by, and the team proceeded to approach it. Just as the ship was about to touch down, it was rocked by numerous impacts. Thus the existence of Graviton Wardens was discovered. The team managed to escape to orbit where they were immediately pursued by Sentinels and Guardians. Fortunately for the team — and CORE — they managed to limp home with the information they gathered.

• SilCORE Stats — Graviton Warden

Size:	4 (Vehicle, Sphere, 2 m)
*Defensive Threat Value:	
Movement:	Flight 20/40
Maneuver:	+1
Armor:	15/30/45
*Miscellaneous Threat Value:	
Crew:	Computer 4 (Sentient 4)

Deployment Range:	n/a
Perks & Flaws:	Communications (+2/10 km, Sat Uplink), Fire Resistant, Hostile Environment Protection (All, Radiation 25), Information Warfare (ECM +2/2 km, ECCM +2/2 km, Stealth 3, Holofield 3), No Fuel Required (Permanent), 2 x Reinforced System (All), Sensors (+2, 5 km), Self-Repair 5

*Offensive & Defensive Systems

Name	Arc	Acc.	DM	BR	ROF	Perks & Flaws	Ammo
Graviton Weapon	T	+1	x15	10	+2	Grav (dual), Armor Crushing, Area Effect 1	Unl.
Graviton Shield	T	+1	x25	Melee	0	Grav (push), Shield (energy, all), Defensive	Unl.

• OGL Stats — Graviton Warden

Type:	Vehicle
Size:	Medium (Sphere, 2 m)
Hit Points:	15+
Occupancy:	None
Armor Hardness:	15
Defense:	9
Spd:	Flight 1200 kph
Tact.Spdx:	Flight 2000 m

Initiative:	+1
Maneuver:	+1
Special Abilities:	Communications (All Types, Interplanetary, Secure), Countermeasures (All), Electronic Counter-Measures (All, +2), Navigation Aids (All), Sensors (All, 10 km), Stealth (All), Stabilization Gear
Exotic Abilities:	Artificial Intelligence (Full, Dex 18, Int 18, Wis 12, Cha 4), Force Field (50 hp), Regeneration 3
Mecha Defects:	None

Weapons:

Name	Dam.	Type	ROF	RI	Ammo	Qualities	Restrictions
Graviton Weapon	8d10	Crush	SA	500 m	Unl.	Incr. Crit. (x3), Incr. Threat (18-20), Invisible, Unl. Shots	n.a

• **SilCORE Stats — Graviton Sentinel**

Size:	25 (Large, Sphere, 400 m)
*Defensive Threat Value:	
Movement:	Flight 20/40
Maneuver:	+1
Armor:	40/80/120
*Miscellaneous Threat Value:	
Crew:	Computer 4 (Sentient 5), Computer 4 (Dumb 4)

Deployment Range:	n/a
Perks & Flaws:	Communications (+2/25 km, Sat Uplink), Hostile Environment Protection (All, Radiation 100), Information Warfare (ECM +2/25 km, ECCM +2/25 km, Stealth 5, Holofield 2), No Fuel Required (Permanent), 2 x Reinforced Systems (All), Sensors (+2, 25 km), Self-Repair 5

*Offensive & Defensive Systems

Name	Arc	Acc.	DM	BR	ROF	Perks & Flaws	Ammo
Graviton Weapon	T	+1	x30	10	+2	Grav (dual), Armor Crushing, Area Effect 1	Unl.
Graviton Shield	T	+1	x50	Melee	0	Grav (push), Shield (energy, all), Defensive	Unl.

G

• **OGL Stats — Graviton Sentinel**

Type:	Vehicle
Size:	Colossal (Large, Sphere, 400 m)
Hit Points:	250
Occupancy:	None
Armor Hardness:	40
Defense:	9
Spd:	Flight 1200 kph
Tact.Spdx:	Flight 2000 m

Initiative:	-1
Maneuver:	-1
Special Abilities:	Communications (All Types, Interstellar, Secure), Countermeasures (All), Electronic Countermeasures (All, +5), Navigation Aids (All), Sensors (All, Global), Stealth (All), Stabilization Gear
Exotic Abilities:	Artificial Intelligence (Full, Dex 18, Int 20, Wis 14, Cha 4), Force Field (100 hp), Regeneration 4
Mecha Defects:	None

Weapons:

Name	Dam.	Type	ROF	RI	Ammo	Qualities	Restrictions
Graviton Weapon	11d12	Crush	SA	5000 km	Unl.	Increased Critical (x3), Increased Threat (18-20), Invisible, Unlimited Shots	n.a.

• **Design Notes: Scaling**

Both the above sets of stats are modified by a factor of ten to represent the large scale of the vessel. Multiply Armor, Damage Multiplier, Base Range, Size, Crew size and internal volumes by a factor of ten to get the base vehicle stats.

CORE Command believes that Graviton technology would prove very effective against the D'Vor and Kabayan; Sentinels and Guardians could be deployed to defend systems along their axis of advance. Unfortunately, neither Guardians nor Sentinels appears to be FTL capable, so they'd need to be constructed on site.

The basic technologies of the Gravitons could also be used in a number of areas beyond defense. Despite the early failures to communicate with or capture a Graviton, CORE Command continues to commit resources to answer the Graviton enigma.

• **SILCORE Stats — Graviton Guardian**

Size:	9 (Gigantic, Sphere, 12 km)
*Defensive Threat Value:	
Movement:	Flight 15/30
Maneuver:	+1
Armor:	40/80/120
*Miscellaneous Threat Value:	
Crew:	Computer 4 (Sentient 6), Computer 8 (Dumb 5)

Deployment Range:	n/a
Perks & Flaws:	Cargo Bay (200,000 m ³), Communications (+3/100 km, Sat Uplink), Hostile Environment Protection (All, Radiation 100), Information Warfare (ECM +3/100 km, ECCM +3/100 km, Stealth 5 Holofield 2), No Fuel Required (Permanent), 2 x Reinforced Systems (All), Sensors (+3, 100 km), Self-Repair 5

*Offensive & Defensive Systems							
Name	Arc	Acc.	DM	BR	ROF	Perks & Flaws	Ammo
Graviton Weapon	T	+1	x30	10	+2	Grav (dual), Armor Crushing, Area Effect 1	Unl.
Graviton Shield	T	+1	x50	Melee	0	Grav (push), Shield (energy, all), Defensive	Unl.

• **OGL Stats — Graviton Guardian**

Type:	Vehicle
Size:	Colossal (Gigantic, Sphere, 12 km)
Hit Points:	250
Occupancy:	None
Armor Hardness:	40
Defense:	9
Spd:	Flight 1200 kph
Tact.Spд:	Flight 2000 m

Initiative:	-1
Maneuver:	-1
Special Abilities:	Communications (All Types, Interstellar, Secure), Countermeasures (All), Electronic Countermeasures (All, +6), Hangar (Colossal), Navigation Aids (All), Sensors (All, Global), Stealth (All), Stabilization Gear
Exotic Abilities:	Artificial Intelligence (Full, Dex 18, Int 22, Wis 14, Cha 4), Force Field (100 hp), Regeneration 5
Mecha Defects:	None

Weapons:								
Name	Dam.	Type	ROF	RI	Ammo	Qualities	Restrictions	
Graviton Weapon	11d12	Crush	SA	5000 km	Unl.	Increased Critical (x3), Increased Threat (18-20), Invisible, Unlimited Shots	n.a.	

• **Design Notes: Scaling**

Both the above sets of stats are modified by a factor of one thousand to represent the Gigantic scale of the vessel. Multiply Armor, Damage Multiplier, Base Range, Size, Crew size and internal volumes by a factor of one thousand to get the base vehicle stats.

• SE-224 Ki-3 Nanovirus

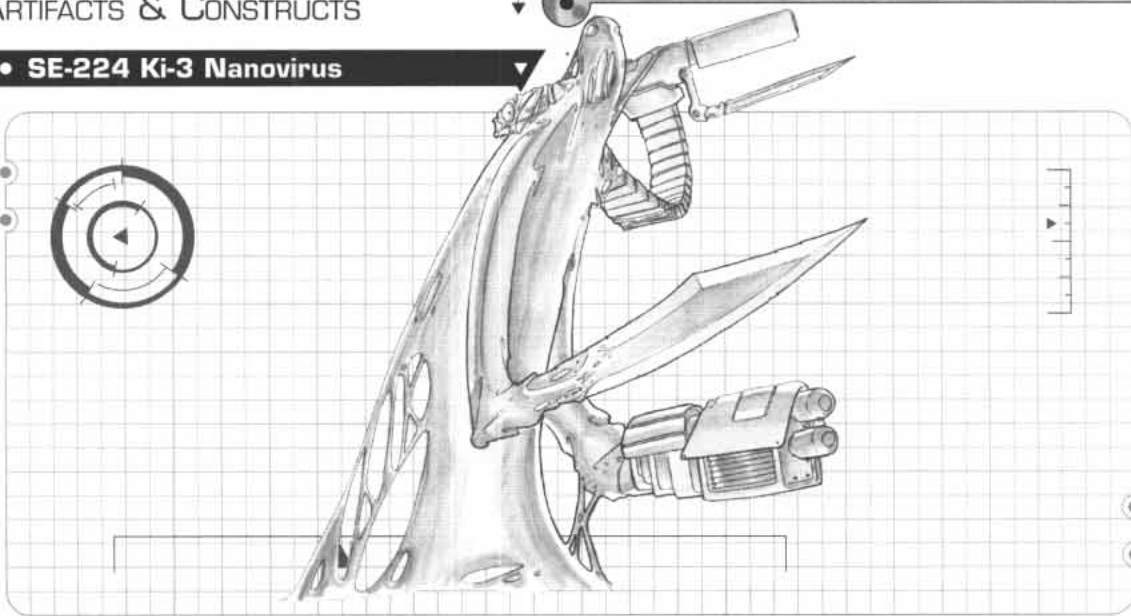

Most people infected with the nanovirus classified by CORE as SE-224 Ki-3 pass it on and recover without ever knowing that they had been infected. Though highly advanced, the nanobots are vulnerable to counterattacks by the host's immune system once they move from infection mode to active mode and begin building higher-level structures. In the few cases where these higher-level structures are not destroyed, the victim usually seeks treatment before the effects have reached dangerous levels. These factors make the virus very difficult to eradicate entirely, even though outbreaks are so rare.

If the nanovirus is allowed to run its course without medical intervention, the victim's body is transformed into a sophisticated killing machine. The nanotech colony-organism is programmed to cause as much damage and chaos as possible. These organisms operate on instinct, with a predatory and territorial behavior pattern. One will claim a region, absorb objects and raw materials found there to improve itself, reproduce, and expand its territory. Intruders provoke a hostile reaction, and will be driven back or killed by whatever means the organism has at its disposal. While the organism cannot transmit the nanovirus and infect new victims, it can reproduce by division. Once a sufficient quantity of material has been absorbed, the creature can divide

in half. The offspring organism is not identical to the parent. Its intelligence is even more rudimentary, it cannot reproduce, and it is subservient to the organism that created it. However, it is just as hostile, and no less dangerous if treated without proper caution.

• Description

The organisms produced by the SE-224 Ki-3 virus look like small piles of silvery goop, about a meter high and half a meter across. While these creatures cannot truly shapeshift, they can alter their shape to interact with their surroundings. They can slither with surprising speed, and extend manipulators, razor-sharp blades, or ranged weapons from their bodies.

In combat, the creature can exude energy blasters from its surface or any manipulator tendrils. The exact nature of these weapons has yet to be determined, as they appear to operate on principles beyond even CORE science. While small, their ability to produce a web of beams covering an area makes them very deadly. SE-224 Ki-3 organisms make a priority of acquiring and absorbing heavy weapons early on in their activity cycle. Energy weapons or slug-throwers with a high rate of fire are favored. Note that Buster Guns cannot be absorbed in a useful form, as their delicate quantek circuitry is destroyed in the absorption process.

The source of the nanovirus has never been found by any of the expeditions sent to search for it. Analysis of nanobots has revealed that there must be such a source, but its whereabouts and nature are unknown. As the first recorded victim was a crewmember of an "unregistered explorer" (a popular euphemism for the independent vessels that search for and loot Dreamworlds), many theories have focused on a Dreamstate race's ancient defense system as the virus' source. Other theories place its origin with the D'Vor, as a terror weapon intended to destabilize the CORE Alliance.

Scientific analysis of SE-224 Ki-3 samples has lead CORE scientists to conclude that there must be a way to reverse the process and recover the individual consumed by the nanovirus to produce the killer organism. Unfortunately for those who have fallen victim to the virus, no clues have been uncovered about how this can be done. In response to this discovery, some worlds have developed a policy of locking victims away in staze vaults, in the hope that a cure can be found. Others retain a policy of extermination with extreme prejudice, reasoning that it is unlikely that a cure will be found anytime soon. If there is a way to reverse the transformation, the secrets of the process were surely well-hidden by the virus' creators, whoever they may be.

• OGL Stats — Nanoviruses

SE-224 Ki-3 Nanovirus: Make a Fortitude save at +2 when exposed to someone with the virus during the 2-week incubation period. At the end of the two-week period, the individual loses 1d6 Con per day as the virus activates, transforming into a Nanovirus Victim when their Con reaches zero.

SE-224 Ki-3 Nanovirus Source: Make a Fortitude save at -6 when exposed to the source. During the 6-month incubation period, any infected individuals spread the virus to others as if they had the nanovirus. At the end of the 6-month period, the individual loses 1d6 Con per day as the virus activates, transforming them into a Nanovirus Victim when their Con reaches zero.

• SiICORE Stats — Nanoviruses

SE-224 Ki-3 Nanovirus: A highly advanced nanovirus that spreads easily, but is also easy for most races' immune systems to fight off. Once it starts producing the larger structures it needs to do its work, the victim's immune system can usually eradicate it. It is ONLY infectious during the onset time, which is not reduced as usual. If the virus activates, it is no longer infectious. An activated virus will transform the victim into a SE-224 Ki-3 Nanovirus Victim over a period of 1 week divided by the margin of failure. A MoS of zero or above means the victim's immune system has fought off the virus. During the contagion or activation period, treatment by an Autodoc will reverse any damage caused by the nanovirus and purge the nanomachines from the subject's system.

Contagion: 10 Onset Time: 2 weeks
Virulence: 3

SE-224 Ki-3 Nanovirus Source: Use these stats for the source of the virus. The nanobots it produces are much more powerful than those produced by self-replication and more resistant to the efforts of the target's immune system. Like the nanovirus itself, this is only infectious during its onset time, but it uses the same stats as the Nanovirus — the Source stats are only for infection from the source itself. Rules for activation are also identical; though note that the Source has a higher Virulence threshold.

Contagion: 15 Onset Time: 6 months
Virulence: 9

• **SILCORE Stats — Nanovirus Victim**

Name:	SE-224 Ki-3 Nanovirus Victim
Size:	2.6 (700 kg)
*Defensive Threat Value (DTV)	
Movement:	Ground 4/8
Maneuver:	-1
Armor:	16/32/48
*Miscellaneous Threat Value (MTV)	

Crew:	Computer 1 (Dumb, Level 3)
Deployment Range:	200 km
Perks and Flaws:	Arms: Manipulator Arm (4, Can Punch) x2, Armor: All-Around, Communications (+0/2km), Hostile Environment Protection (Vacuum, Extreme Heat, Extreme Cold), Sensors (+1/500m), Nanotech: Material Absorption (10), Nanotech: Self-Repair (2), Negative Features: Vulnerable to Haywire Effects

*Offensive Threat Value (OTV)

Name	Arc	ACC	DM	BR	ROF	Perks & Flaws	Ammo
Stray-Web Blasters	T	+0	x6	2	+0	Anti-Infantry, Concealed, Scatter	Unl.
Force Blades	T	+0	x8	Melee	+0	Parry, Stealth	Unl.
(opt.) Heavy Plasma Gun	T	+0	x10	4	+0	-	40
(optional) Machinegun	T	+0	x3.5	3	+2	Anti-Infantry	500

• **OGL Stats — Nanovirus Victim**

Name:	SE-224 Ki-3 Nanovirus Victim
Type:	Giant Robot
Size:	Medium
Hit Points:	18
Occupants:	0
Armor Hardness:	16
Defense:	9
Strength:	35

Tactical Speed:	Land 45 kph
Maneuver:	-2
Initiative:	0
Special Abilities:	Sensors (Global, Radar/infrared 500m)
Exotic Abilities:	A.I. (Full, Dex 14, Wis 6, Int 12, Cha 4), Self-Repair
Mecha Defects:	none

Weapons:

Name	Dam.	Type	RoF	RI	Ammo	Qualities	Restrictions
Stray-Web Blaster	2d6	Laser	Single-Shot	150m	Unl.	Unl. Shots, Cone, Concealed	None.
Force Blades	2d6	Slashing	Single-shot	Melee	Unl.	Infinite Ammo, Silent, Incr. Threat (18-20)	Melee
(opt.) Hvy. Plasma Gun	3d8	Plasma	Single-shot	200m	40	None.	None.
(opt.) Machinegun	2d10	Ballistic	Automatic	150m	500	Automatic.	None.

• **SiICORE Stats — Nanovirus Victim**

Name:	SE-224 Ki-3 Nanovirus Child
Size:	2.1 (350 kg)
Defensive Threat Value (DTV)	
Movement:	Ground 4/7
Maneuver:	+0
Armor:	12/24/48
Miscellaneous Threat Value (MTV)	

Crew:	Computer 1 (Dumb, Level 2)
Deployment Range:	200 km
Perks and Flaws:	Arms: Manipulator Arm (3, Can Punch) x2, Armor: All-Around, Communications (-1/2km), Hostile Environment Protection (Vacuum, Extreme Heat, Extreme Cold), Sensors (+0/500m), Nanotech: Material Absorption (8), Nanotech: Self-Repair (2), Negative Features: Vulnerable to Haywire Effects

Offensive Threat Value (OTV):							
Name	Arc	ACC	DM	BR	ROF	Perks&Flaws	Ammo
Stray-Web Blasters	T	+0	x6	2	+0	Anti-Infantry, Concealed, Scatter	Unl.
Force Blades	T	+0	x6	Melee	+0	Parry, Stealth	Unl.

4

• **OGLStats — Nanovirus Child**

Name:	SE-224 Ki-3 Nanovirus Child
Type:	Giant Robot
Size:	Medium
Hit Points:	17
Occupants:	0
Armor Hardness:	12
Defense:	9
Strength:	24

Tactical Speed:	Land 45 kph
Maneuver:	-2
Initiative:	0
Special Abilities:	Sensors (Global, Radar/infrared 500km)
Exotic Abilities:	AI (Full, Dex 14, Wis 6, Int 12, Cha 4), Self-Repair
Mecha Defects:	none

Weapons								
Name	Dam.	Type	RoF	RI	Ammo	Qualities	Restrictions	
Stray-Web Blaster	2d6	Laser	Single-Shot	150m	Unl.	Unlimited Shots, Cone, Concealed	None.	
Force Blades	2d6	Slashing	Single-shot	Melee	Unl.	Infinite Ammo, Silent, Incr. Threat (19-20)	Melee	

• D'vor Destroyer

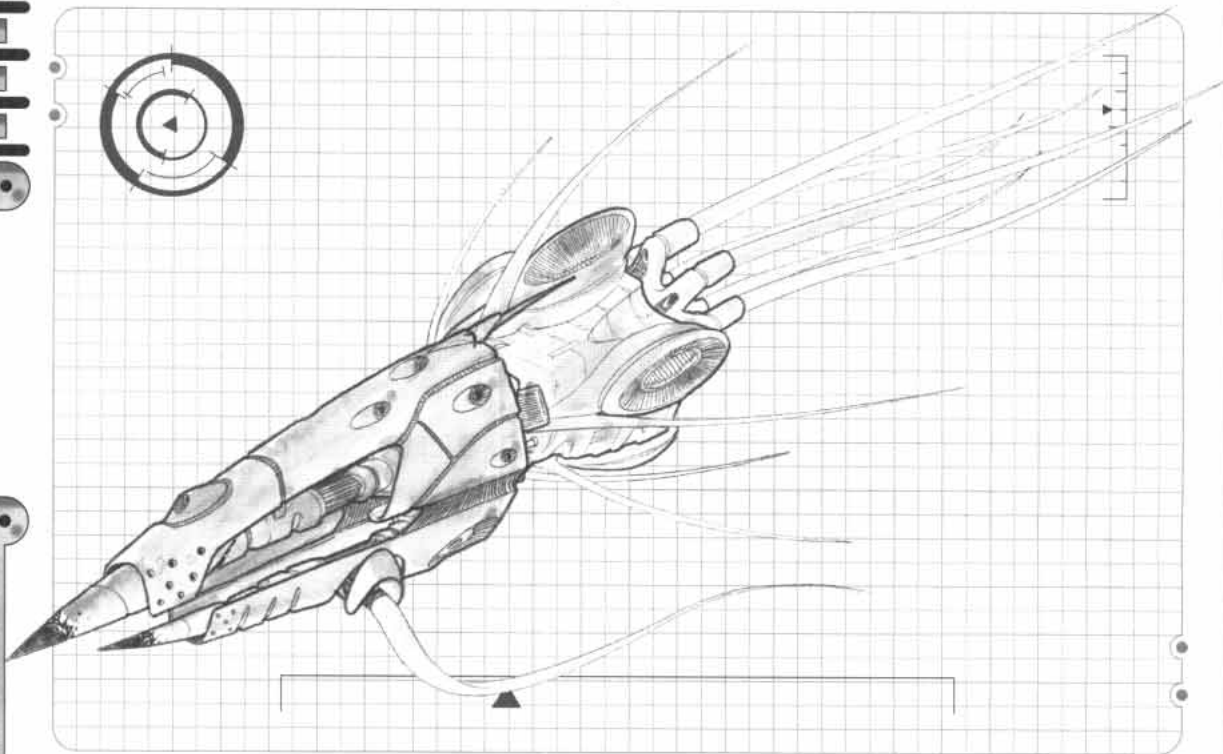

• Description

The Destroyer is a fearsome variant of the standard D'vor Hunter-Killer, though fortunately it is nowhere near as common. No one knows quite why, but it has been hypothesized that the D'vor directing intelligence (whatever and wherever they may be) see no reason to spend resources on such an overpowered vessel — there are simply not enough worthwhile targets.

The Destroyer is armed with a single weapon, and nothing else, not even close-in defense turrets. The massive Ion Discharger takes up most of the forward section of the hull and consumes a large amount of the ship's total generator output.

This vicious and fast bioship is a predator related to the Star Devourers. HKs are used to eliminate the opposition, and feed off the gases and plasmas rejected by the Star Devourer. Size is near to a kilometer in length. The rear section of the hull is composed of quadruple

engine exhaust ports centered on a cluster of waving tentacles, the latter being a combination of heat sinks and hyper-shunt governors. Like their brethren, Destroyers are generally too aggressive to accept any passengers except their own internal repair drones.

Unlike Hunter-Killers, Destroyers tend to hunt singly, but like the Hunter-Killers they have demonstrated a chilling intelligence and malevolence. A Destroyer will often spend considerable time maneuvering with the target to ensure maximum effect for its already devastating weaponry.

SILCORE Stats

Name:	D'vor Destroyer
Size:	3 (Gigantic, Long, 5 km)
*Defensive Threat Value (DTV)	
Movement:	Flight 25/50
FTL:	1000C, 100,000 LY, 1-minute activation (Multiplier x4096)
Maneuver:	-2
Armor:	12/24/36

*Miscellaneous Threat Value (MTV)	
Crew:	Computer 4 (Sentient, Level 3)
Deployment Range:	500 hrs
Perks and Flaws:	Accessories: Full Life Support; Communications (+0/100 km, Satellite Uplink); Features: Fire Resistant, No Fuel Required (Permanent), Reentry Systems (Permanent), Hostile Environment Protection (All, Radiation 100); Reinforced Systems (Structure); Sensors (+0/10 km)

*Offensive Threat Value (OTV)							
Name	Arc	Acc.	DM	BR	ROF	Perks & Flaws	Ammo
Ion Discharger	FF	-4	x15	15	-10	Disintegrators	Unl.
Force Screen	T	0	x3	Melee	0	Shield (Energy, All), Defensive	Unl.

4

OGL stat block

Type:	Vehicle
Size:	Large (Gigantic, Long, 5000 m)
Hit Points:	40
Occupancy:	N/A
Armor Hardness:	12
Defense:	0
Speed:	Air 1500 kph, FTL 1,000C
Tactical Speed:	Air 2500 m

Initiative:	-6
Maneuver:	-6
Special Abilities:	Communications (All Types, Interstellar, Secure), Countermeasures (All), Ejection Pods, Electronic Countermeasures (All, +4), Environmental Systems (Life Support), Hangar (Large), Navigation Aids (All), Re-entry Shield, Room (Workshop +5); Sensors (All Types, Global); Stabilization Gear.
Exotic Abilities:	Artificial Intelligence (Full, Dex 8, Int 12, Wis 4, Cha 4), Force Field (100 hp), Self-Repair.
Mecha Defects:	N/A

Weapons:							
Name	Dam.	Type	ROF	RI	Ammo	Qualities	Restrictions
Ion Discharger	6d20	Plasma	SS	15,000 km	Unl.	Increased Threat (10-20), Stream, Unlimited Shots	Arc (Fixed Front)

Design Notes: Scaling

Both the above sets of stats are modified by a factor of one thousand to represent the Gigantic scale of the vessel. Multiply Armor, Damage Multiplier, Crew size, internal volumes, etc., by a factor of one thousand to get the actual vehicle stats (for example, the actual Silhouette vehicle scale armor rating is 12,000. The number listed — 12 — is to be used when fighting against other Gigantic scale vessels, to avoid having to drag extra zeroes around.

• D'vor Brood-Mother

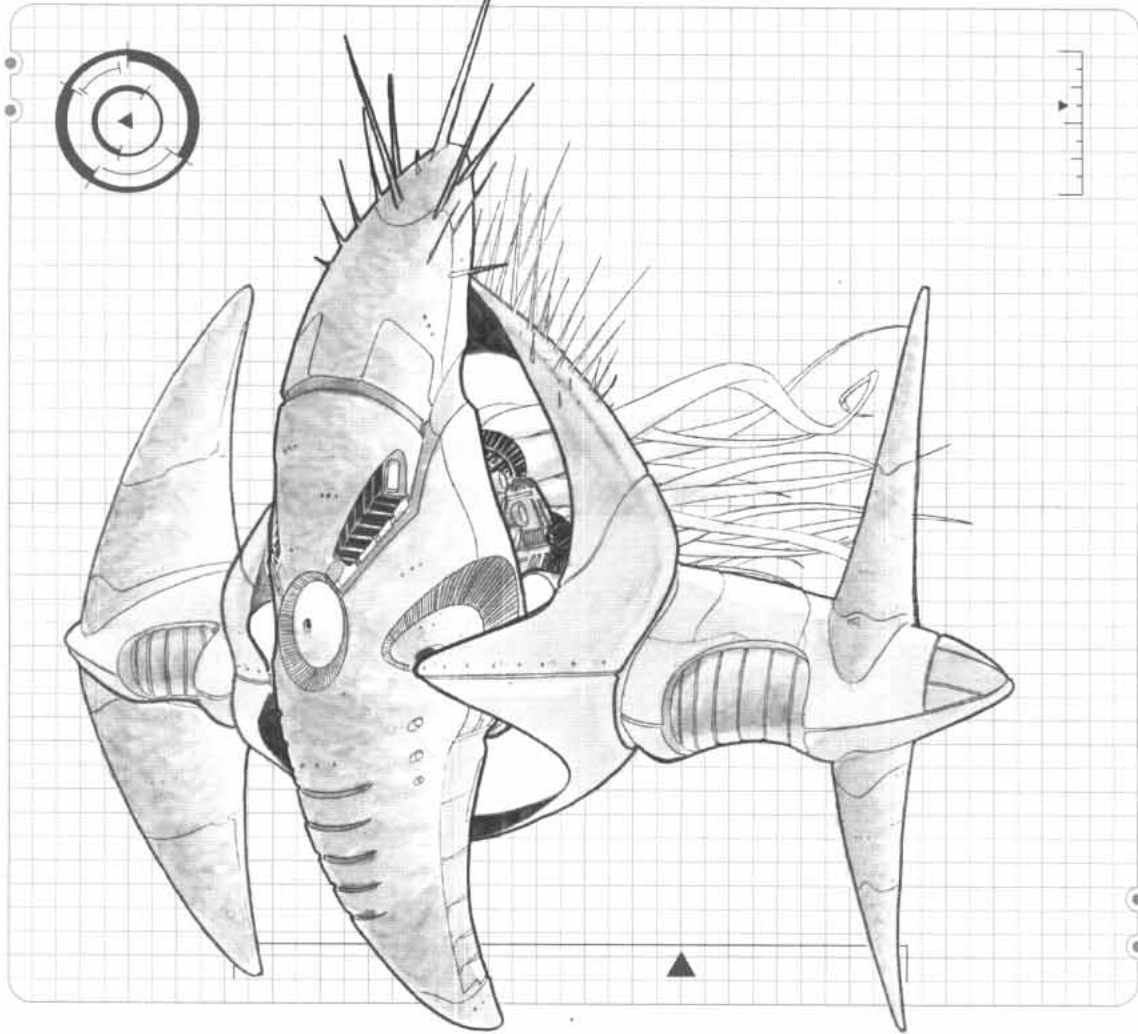

• Description

The Brood-Mother is a variant of the common Gatherer-Breeder D'vor vessel. They both share the same basic hull design and propulsion assembly, but the similarity ends there. Whereas the Gatherer-Breeder's task is to find food and resources to make new units for the Artifact fleet, the Brood-Mother is a giant transport and refueling craft.

Like the Gatherer-Breeders, the Brood-Mothers are slow, but well armored. They carry few weapons, and those mounted tend to be short-ranged energy dischargers largely electrical in nature. They rely mostly on escorts for

defense, and are rarely encountered without an accompaniment of some form (usually several dozen HKs). Brood-Mothers do not appear to be as intelligent as some of the other artifact ship types, though they have shown much more fortitude under fire.

• **SilCORE Stats**

Name:	Brood-Mother
Size:	3 (Gigantic, Tall, 5 km)
*Defensive Threat Value (DTV)	
Movement:	Flight 6/12
FTL:	1000C, 100,000 LY, 1-minute activation (Multiplier x4096)
Maneuver:	-6
Armor:	10/20/30

*Miscellaneous Threat Value (MTV)	
Crew:	Computer 4 (Sentient, Level 3)
Deployment Range:	500 hrs
Perks and Flaws: Accessories: Full Life Support; Communications (+0/100 km, Satellite Uplink); Features: Cargo Bays (50,000 m ³), Fire Resistant, No Fuel Required (Permanent), Reentry Systems (Permanent), Hostile Environment Protection (All, Radiation 100); Reinforced Systems (Structure); Sensors (+0/10 km)	

*Offensive Threat Value (OTV)							
Name	Arc	Acc.	DM	BR	ROF	Perks & Flaws	Ammo
Electro-Dischargers	T	-1	x1	5	0	Haywire	Unl.

• **OGL stat block**

Type:	Vehicle
Size:	Large (Gigantic, Tall, 5000 m)
Hit Points:	40
Occupancy:	1000 tons cargo
Armor Hardness:	10
Defense:	0
Speed:	Air 90 kph, FTL 1,000C
Tactical Speed:	Air 150 m

Initiative:	-2
Maneuver:	-2
Special Abilities: Communications (All Types, Interstellar, Secure), Countermeasures (All), Ejection Pods, Electronic Counter-Measures (All, +4), Environmental Systems (Life Support), Navigation Aids (All), Re-entry Shield, Sensors (All Types, Global), Stabilization Gear.	
Exotic Abilities: Artificial Intelligence (Full, Dex 14, Int 10, Wis 4, Cha 4), Force Field (100 hp), Self-Repair.	
Mecha Defects:	N/A

Weapons:							
Name	Dam.	Type	ROF	RI	Ammo	Qualities	Restrictions
Defensive Dischargers	4d4	Plasma	S	2500 km	Unl.	Incr. Threat (19-20), Stream, Unlimited Shots	-

• **Design Notes: Scaling**

Both the above sets of stats are modified by a factor of one thousand to represent the Gigantic scale of the vessel. Multiply Armor, Damage Multiplier, Crew size, internal volumes, etc., by a factor of one thousand to get the actual vehicle stats (for example, the actual Silhouette vehicle scale armor rating is 10,000. The number listed — 10 — is to be used when fighting against other Gigantic scale vessels, to avoid having to drag extra zeroes around.

• Stellar Devourer

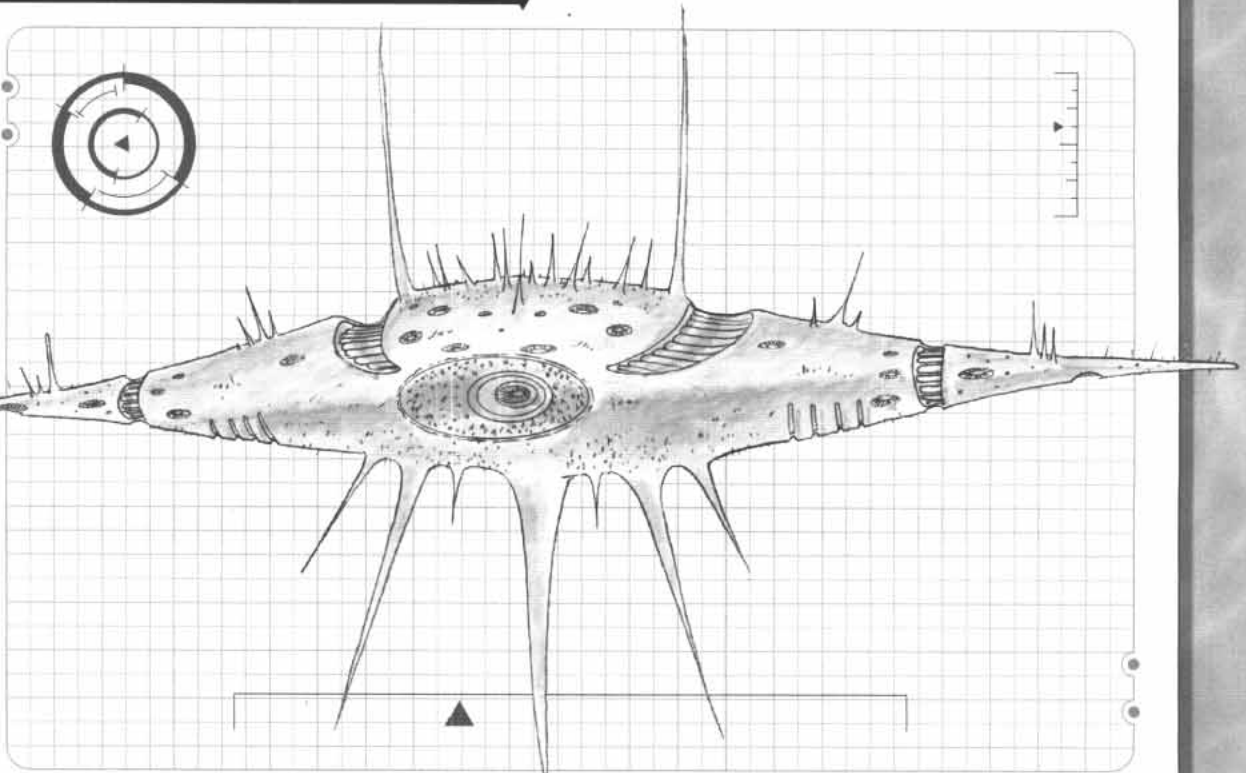

• Description

The Stellar Devourer is the largest D'vor artifact vessel ever encountered by CORE fleets. It is larger than most planets, yet is mobile. The mere presence of its mass within a solar system is enough to perturbate celestial orbits and creates devastating tides on all planets within the system — terrible dangers which become moot once the creature starts to feast on the local sun.

Outwardly, the Devourer shares many characteristics with its smaller brethren. The knobby surface has a quasi-organic look to it, though the common D'vor tentacle-like antennae/weapon/heat-sink assemblies are absent and replaced by elongated spines. This might be required for structural strength, as the spines span hundreds of kilometers apiece. The skin of the vessel is near-impervious to damage: what does manage to break the immensely tough, self-reinforcing

long chain polymers that compose it will merely dig a crater in a panel that may be up to one-kilometer thick.

The surface is broken by numerous large weapon emitters (which tend to concentrate on targets in groups and lack accuracy), the cavernous maws of the frontal star-cutters, and an almost infinite number of airlocks and access ports — some of them large enough to swallow an entire spaceship — that lead to the creature-ship's interior. These entry points are guarded by several D'vor ships or creatures (Krabbs are common) and may not be such a large weakness in the overall design.

• **SilCORE Stats**

Name:	D'vor Stellar Devourer
Size:	600 (Gigantic, Long/Large, 100,000 km)
*Defensive Threat Value (DTV)	
Movement:	Flight 1/2
FTL:	1000C, 1B LY, 10-minute activation
Maneuver:	-10
Armor:	1500/3000/3500
*Miscellaneous Threat Value (MTV)	

Crew:	Computer 16 (Sentient, Level 5)
Deployment Range:	Unlimited
Perks and Flaws:	Accessories: Full Life Support; Communications (+2/1000 km, Satellite Uplink); Features: Accommodations (5,000 km ³), Cargo Bay (5,000 km ³), Fire Resistant, No Fuel Required (Permanent), Hostile Environment Protection (All, Radiation 100); Information Warfare: ECM (+2/10km); Reinforced Systems: Backups x 5; Sensors (+2/100 km)

*Offensive Threat Value (OTV)

Name	Arc	Acc.	DM	BR	ROF	Perks & Flaws	Ammo
Star Cutters	FF	-5	x25	100	-10	Disintegrators	Unl.
Defensive Dischargers	L	0	x10	5	0	Wide-angle (180)	Unl.
Defensive Dischargers	R	0	x10	5	0	Wide-angle (180)	Unl.
Prim. Force Screen	T	0	x100	Melee	0	Shield (Energy, All), Defensive	Unl.
Sec. Force Screen	T	0	x100	Melee	0	Shield (Energy, All), Defensive	Unl.

• **OGL stat block**

Type:	Vehicle
Size:	Colossal (Gigantic, Long/Large, 1,000,000 km)
Hit Points:	10,000
Occupancy:	5M tons cargo
Armor Hardness:	1500
Defense:	n/a
Speed:	Air 60 kph, FTL 1,000C
Tactical Speed:	Air 150 m
Initiative:	-20

Maneuver:	-20
Special Abilities:	Communications (All Types, Interstellar, Secure), Countermeasures (All), Electronic Counter-Measures (All, +10), Environmental Systems (Life Support), Hangar (Colossal), Navigation Aids (All), Rooms (Kitchen, Conference Room, Science Lab, Workshop), Sensors (All Types, Global), Stabilization Gear.
Exotic Abilities:	Artificial Intelligence (Full, Dex 18, Int 18, Wis 18, Cha 10), Force Field (1000 hp), Self-Repair.
Mecha Defects:	N/A

Weapons:

Name	Dam.	Type	ROF	RI	Ammo	Qualities	Restrictions
Star Cutters	10d12x10	Plasma	S	5000 km	Unl.	Incr. Threat (10-20), Stream, Unl. Shots	Arc (Fixed Front)
Defensive Dischargers	10d4x10	Plasma	S	2500 km	Unl.	Incr. Threat (19-20), Stream, Unl. Shots	Arc (Left)
Defensive Dischargers	10d4x10	Plasma	S	2500 km	Unl.	Incr. Threat (19-20), Stream, Unl. Shots	Arc (Right)

• **Design Notes: Scaling**

Both the above sets of stats are modified by a factor of one thousand to represent the Gigantic scale of the vessel. Multiply Armor, Damage Multiplier, Crew size, internal volumes, etc., by a factor of one thousand to get the actual vehicle stats (for example, the actual Silhouette vehicle scale armor rating is 1,500,000. The number listed — 1500 — is to be used when fighting against other Gigantic scale vessels, to avoid having to drag extra zeroes around.

• Large Locations

Though the hull of the ship itself is incredibly tough, other locations on the surface and within the vessel aren't. It's possible to attack these separately from the whole of the ship if within a thousand kilometers of the surface (some targets are smaller and require even closer assault).

Large Star Cutter Maw: This large (5000 km) opening is the primary emitter for the Star Cutter beam. If the large maw is destroyed, the Star Cutter cannot be used.

Small Star Cutter Maw: This is a secondary beam guide emitter used to keep the main Star Cutter under control. It's much smaller (only 2000 km) and more easily damaged — in relative terms, of course. There six such emitters on the front end of the Devourer; for each destroyed, the Damage Multiplier of the Star Cutter drops by 2 as some energy is lost and unused in the firing process.

Defensive Discharger Zone: The surface of the Stellar Devourer is covered with multiple defensive emplacements that are used against starship opponents. Each of these emplacements contains an energy projector the size of a small house, along with the required generators and targeting devices. The emplacements are grouped in ten zones on each side of the vessel, and combine their firepower to saturate the entire broadside. Whenever the emplacements within a zone are destroyed, some of the survivors in other zones shift their targeting to ensure that there will be no blind spot in the fire pattern. This, of course, reduces the overall density of firepower. There are ten zones on each side; for each destroyed, the Damage Multiplier drops by 1.

Force Screen Emitters: Although the Devourer is physically very tough, it can be hurt by a sufficiently powerful attack. While anything can be repaired or regenerated with time, this

consumes hard to come by resources. The Devourer is thus equipped with a nested set of force screens that are projected through a series of kilometer-tall towers on its surface. There are two hundred such projectors for each screen; for each destroyed, the DM of one screen drops by 1.

Cargo Bay Door: There are several large cargo bays located on the upper and lower surface of the spacecraft. They are of varying sizes, but most span a few kilometers in width and length (depth is generally only a couple of kilometers). They are used to transport both dormant and active D'vor vessels and creatures, but are also likely to hold spare resources such as comets or asteroids in the process of being dismantled by the internal maintenance creatures. Access to these bays is through a five-kilometer wide bay door. If the latter is destroyed, the bay remains opened to space.

• Designer Note: Impossible Odds

Astute gamers will take one look at the stats and scoff. The Stellar Devourer has been intentionally designed to be near-indestructible: one cannot just grab a single ship and go against it. If ever characters are forced to tangle with it, they'll have to assemble one of the largest fleets in galactic history (see the Squadron rules in the **CORE Command Player's Handbook**), a major, extended feat of diplomacy. The alternative is to board the creature and drop an anti-matter bomb near its braincase (see next pages). This task won't be easy as the cavernous interior is populated with multiple defense drones and assorted D'vor creatures...

CHAPTER FOUR:
ARTIFACTS & CONSTRUCTS

• Small Locations

Some locations on the surface and within the vessel are almost human-scaled. It's possible to attack these separately from the whole of the ship if within a thousand meters of the surface.

Hatch: There are an estimated half-million hatches on the surface of the Stellar Devourer, each of them large enough to release a Kraab or similar D'Vor creatures. The hatches are incredibly tough on their own (though few will stand up to a true starship's weapons), but even if they are destroyed a secondary hatch can be found a few meters back, though this one has only one-tenth the armor. Hatches usually lead to wide corridors that make their way to within the first hundred kilometers or so within the vessel.

Airlock: These are small, man-size access hatches that are clustered around the edges of main cargo doors and major external systems. It is believed that there are more than one million of them on the entire surface, based on extrapolating clustering density. They are probably used for ongoing maintenance.

The airlocks are tough but not impossible to destroy by a well-equipped team. If they are destroyed a secondary airlock door can be found a few meters back, though this one has only one-tenth the armor and durability. These lead to small, twisting corridors that connect to everywhere within the vessel.

SIZE COMPARISON CHART

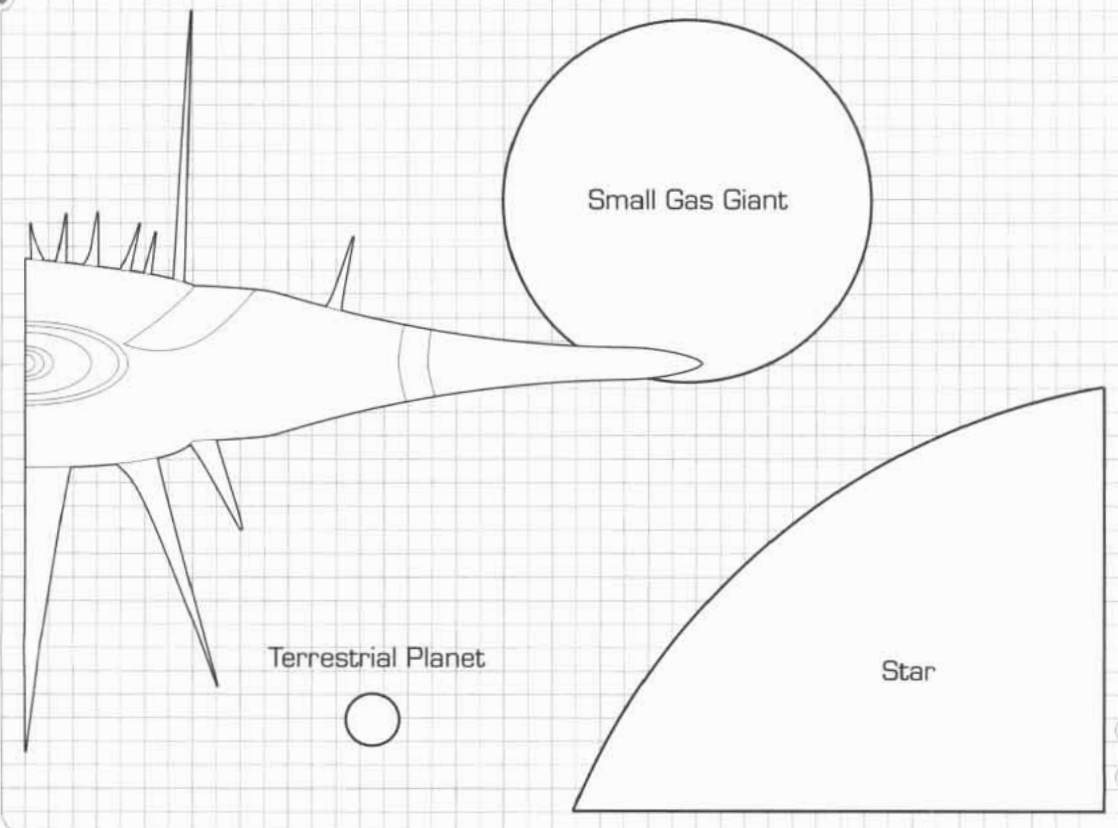

● **SilCORE Stats: Location/Item**

Location	Number	Armor Rating*	Effect
Large Star Cutter Maw	1	800	Star Cutter cannot be used
Small Star Cutter Maw	6	350	For each destroyed, DM drops by 2
Defensive Discharger Zone	10/10	350	For each destroyed, DM drops by 1
Prim. Force Screen Emitter	100	100	For each destroyed, DM drops by 1
Sec. Force Screen Emitter	100	100	For each destroyed, DM drops by 1
Cargo Bay Door	10	100	See text description
Hatch	0.5M	10	See text description
Airlock	1M	1	See text description
Internal Bulkhead	-	0.1	See text description
Internal Partition	-	0.01	See text description

*Subject to the Gigantic scale (x1000) multiplier

● **OGL Stats: Location/Item**

Location	Number	Hardness*	Hp*	Effect
Large Star Cutter Maw	1	80	30	Star Cutter cannot be used
Small Star Cutter Maw	6	35	15	Per destroyed, # of damage dice drops by 1
Defensive Discharger Zone	10/10	35	15	Per destroyed, # of damage dice drops by 1
Prim. Force Screen Emitter	100	10	5	Per destroyed, # of damage dice drops by 1
Sec. Force Screen Emitter	100	10	5	Per destroyed, # of damage dice drops by 1
Cargo Bay Door	10	10	5	See text description
Hatch	0.5M	1	1	See text description
Airlock	1M	0.1	1	See text description
Internal Bulkhead	-	0.1	0.1	See text description
Internal Partition	-	0.01	0.01	See text description

*Subject to the Gigantic scale (x1000) multiplier

Internal Bulkhead: These heavy structural walls and partitions can be found every half-kilometer or so. While they are thick and tough, they are pierced at regular intervals by openings and iris doors, and thus don't represent a real obstacle unless the doors are defended. Every ten kilometers, a bulkhead has a double thickness and serves as a structural support.

Internal Partition: These separate the entire of the vessel in numerous smaller chambers (the size of which varies wildly). They are tough but far from indestructible, and they are pierced at regular intervals by openings and iris doors.

● **Internal Exploration**

Although a Stellar Devourer can be taken down by a large enough fleet (albeit at immense costs in casualties), a better way is to board it and destroy it from the inside. Most Devourers lack internal defenses beyond the occasional pit or crushing door, and rely mainly on the other D'vor creatures they carry for protection. The latter act as mobile antibodies, roaming through the ship to take down intruders and malfunctioning maintenance machines alike.

No two Devourers are alike in internal configuration, and maps of previous encounters are quite useless. The brain tends

to be located at the very center of the ship. Most attackers prefer to enter from the top or bottom of the hull to reduce their travel time, but this forces them to travel through more densely populated regions. Attacking from the edges takes more time, but results in less encounters.

Most main corridors are wide enough to accept a small ship, and continue from the cargo bays and the farther reaches of the hull all the way to within a thousand kilometers of the core. Afterward, corridors become smaller, barely able to fit a battlepod. Smaller access branches crisscross the ship in between, just wide enough to admit a single person.

• Specific Features

Defenders: The corridors of the ship are swarming with D'vor creatures of all types. Most of these are harmless maintenance machines that completely ignore intruders and will passively absorb any attack. They range from the man-sized scrubber (a fat, black caterpillar drone used to keep the corridors clean) to the car-sized scavenger (a mobile dumpster — although its maw breaks down almost any matter placed within, it moves so slowly (about one meter per minute) that it's easy to avoid).

Internal Atmosphere: The ship maintains a low oxygen, low pressure internal atmosphere to help its drones function more efficiently (many designs breathe air to fuel biochemical power reactions within themselves). The oxygen content is barely high enough to allow a human or similar race to breathe. The air is humid and filled with a musty smell, interlaced with a hint of ozone whenever one is near a power node.

Brain: The main control device for the entire ship is located at the very center of the hull, right in front of the main energy core. The brain is about the size of a small car and is both very tough and very delicate. The brain casing has the same toughness as an entire bulkhead, although it's much smaller. Any attack that manages to get past the thick armor plates will annihilate it.

The brain is thus the most vulnerable location by far — if destroyed, a cataclysmic chain reaction occurs as the energy core (see next entry), deprived of the delicate constant power adjustments it needs, goes off-balance and into a critical mode. This destroys the entire vessel within 1d6 minutes.

Energy Core: This isolated section takes up most of the rear third of the ship. It's within its closed confines that the titanic energies required to move this planet-sized mass are generated and channeled. There is no access to this section other than the opening through which the power relays and cables (some of which are many kilometers in diameter) pass through. Anything that enters the energy core is automatically vaporized.

The energy core's walls have the same thickness and strength as the cargo bay doors. Any damage that beats the armor or hardness of the wall create a breach from which high density plasma is vented. Anything that touches the ten meter-wide stream is vaporized, no matter its armor.

• Internal Defender Strategies

The interior of the Star Devourer lacks advanced sensor systems, and thus intruders are able to move at a relatively good pace without fear of detection, as long as they destroy any unit they encounter before it has a chance to sound the alarm. In general, all but one combat units will fight to destruction while a single one will escape to round up reinforcements in the sector (a zone approximately ten kilometers on the side).

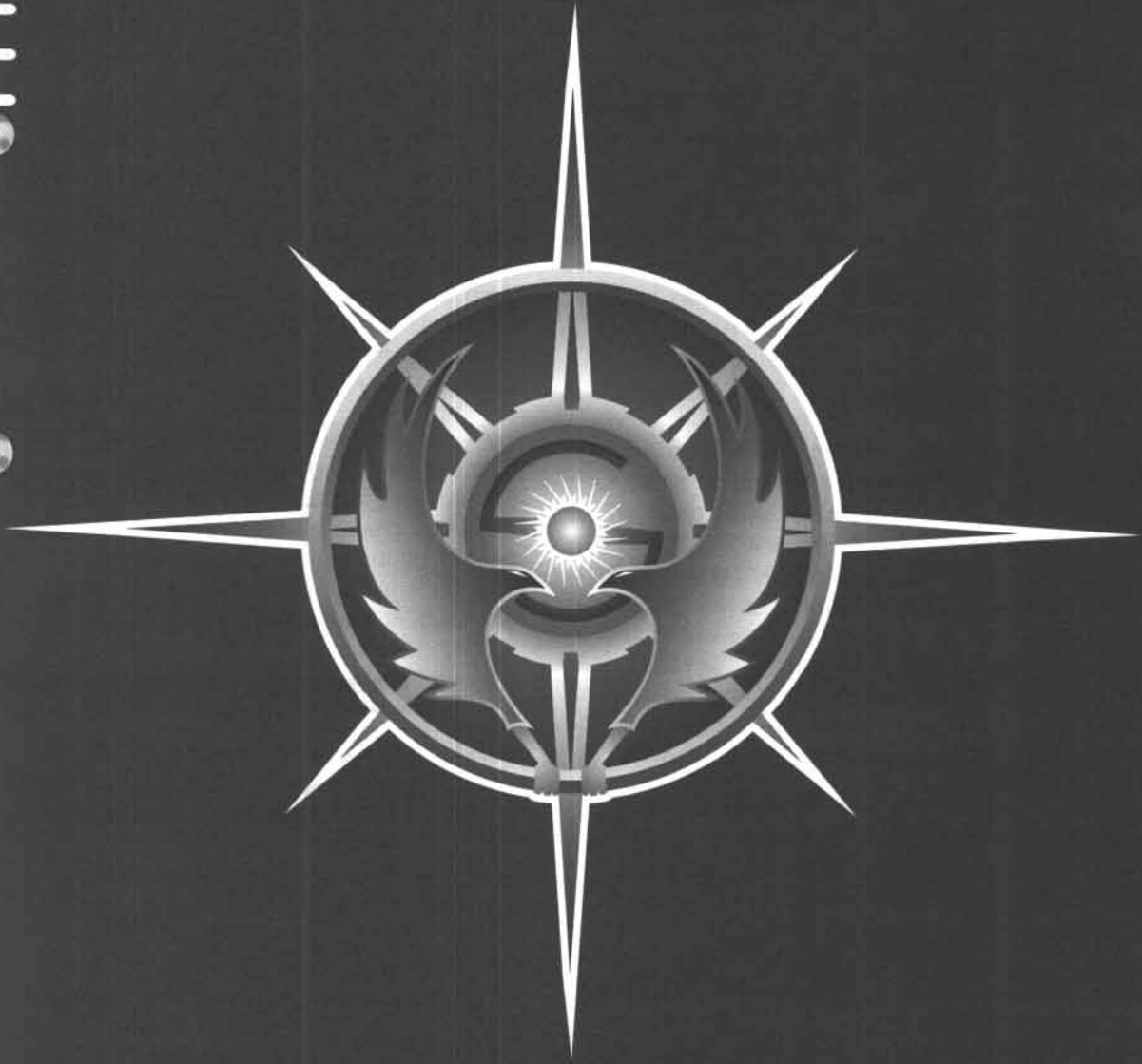

CHAPTER 5:
Threats



CHAPTER FIVE: EQUIPMENT AND WEAPONS

• Tools of the Trade

Unfortunately for a large number of living beings in the Five Galaxies, a significant portion of the industrial and scientific output of many races is composed of weaponry and other tools of warfare. Whether it's for export or local use, these deadly devices often end up traveling far throughout the galaxy to end up in the hands (or manipulator appendages) of races or societies that may not be ready for them.

• Kabayan Technology

The Kabayans have never been very science-oriented, and prefer to use slave workers and stolen (or traded) fabricator machines to do their bidding. Through a combination of threats and promises, they manage to staff entire workshops dedicated solely to the production of weaponry. As the Kabayans are not very keen on the concept of training (except for martial purposes), most of the slaves must learn their tasks on the fly. This greatly reduce the workshop's output and limits them to relatively simple weapons such as melee armament and primitive armor types.

• Grob Technology

The Grob tribes do include some technicians and scientists of sort, but they are more concerned with keeping the group's ships in working order than producing anything. The situation is made worse by the fact that Grob society lacks organized training programs, and thus all their technical people must pick up knowledge as they go — a process that has a tendency to perpetuate mistakes and falsehoods. For this reason, the Grobs prefer to stick with the tried-and-true, especially for critical systems such as life support modules and weaponry.

• Other Races

Most of the weaponry of other aggressive races in the Galaxies are built using autofacs or fabricators of somekind, except for the simpler devices (melee weapons, projectile weapons) which are sometimes assembled by hand. There are exceptions — the weaponcrafters of Indara VI, for example, use a type of neural connectors to mentally direct the shaping of the item they are making, directing lasers and force webs to deposit atoms and molecules layers by layers in the desired shapes. Indaran weapons are comparable in power output to other similar weapons of the same types, but are significantly stronger and more accurate. The process is extremely long and require great mental control, and thus such weapons are extremely rare; often, they will be gifts from a grateful weaponcrafter. Indaran weapons are virtually indestructible, and some have been found in perfect working order within century-old collapsed buildings.

Indaran Silhouette Stats: Treat as a weapon of the desired type (example, a laser pistol), but add +1 to Accuracy. Weapon has +300 Armor if hit. Requires one week to craft per point of Damage Multiplier.

Indaran OGL Stats: Treat as a *Mastercraft +2* weapon. Add +1000 to weapon's base Hardness if hit. Requires one week to craft per point of damage output (use maximum value).

• Aracknati Rail Rifles

Given their natural marksmanship abilities, it's no wonder that the Aracknati have primarily developed line-of-sight weapons. While they are quite fond of beam guns of all types, they also have a soft spot for their rail rifles, a comparatively primitive technology that is nonetheless quite effective.

A rail rifle is an electromagnetic gun that uses a strong current between twin metal rails to accelerate a projectile at enormous speeds. This, in turn, means that the projectile has more momentum and less time to be affected by external factors such as gravity fields or wind, thus improving both penetration power and accuracy.

The ammunition for the rail rifle is a short polymer cylinder that contains both the slim projectile and its launch sabot, and a reserve of potent chemicals. When a round is chambered, the chemicals are injected in a reaction chamber at the rear of the gun, where they produce an enormous electrical discharge that propels the dart downrange.

The **Assault Rail Rifle** is a short, almost stubby version of the weapon. It's used when the surroundings are confined, or where long range isn't particularly important, but accuracy is. It suffers from a poor ammunition load: only six rounds can be placed in the external rack (though it can be adapted for belt feeding).

The **Light Rail Rifle** has a slightly longer muzzle and a consequent longer range. It shares many parts with the Assault version, such as the reaction chamber.

The **Heavy Rail Rifle** is a much larger version of the weapon. Due to its heavy recoil, it is designed to be shot from the hip with the help of a head-mounted targeting display, or fired from a tripod or grav-mount base. The 18-round drum magazine can be replaced by a belt if desired.

• Assault Rail Rifle

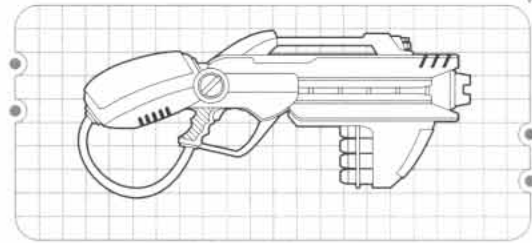

Silhouette CORE Stats:

ACC +1, DM x 35, BR 50m, ROF 0, Armor-Piercing, Wt. 2 kg

6 shots/clip or belt-fed

Open Gaming Stats:

Dam. 2d10, Crit. (19-20), RI 70 ft, Piercing

6 shots/clip or belt-fed

• Light Rail Rifle

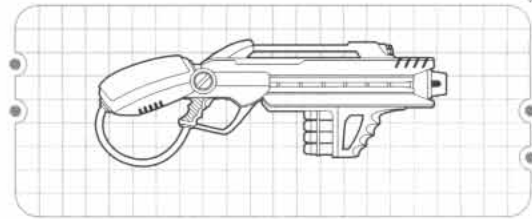

Silhouette CORE Stats:

ACC +1, DM x 35, BR 75m, ROF 0, Armor-Piercing, Wt. 2.5 kg

6 shots/clip or belt-fed

Open Gaming Stats:

Dam. 2d10, Crit. (19-20), RI 90 ft, Piercing

6 shots/clip or belt-fed

• Heavy Rail Rifle

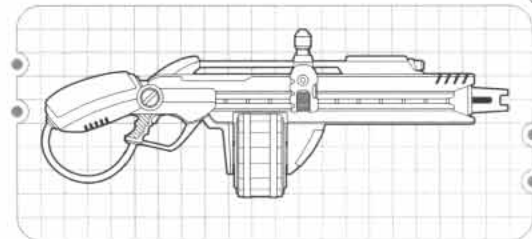

Silhouette CORE Stats:

ACC +1, DM x 40, BR 250m, ROF 0, Armor-Piercing, Wt. 6 kg

18 shots/clip or belt-fed

Open Gaming Stats:

Dam. 2d12, Crit. (19-20), RI 275 ft, Piercing

18 shots/clip or belt-fed

• Grob Blasterguns

The Grob blasterguns are midway between a standard rifle and a heavy weapon. Their design blueprints are not very common among the Grob tribes, and as such they are harder to find than the other Grob weapons described in other manuals. Their main advantage is that they have heavy weapon-like output, but are small and short enough to be handled like a normal rifle.

Both blasterguns are plasma discharge weapons, which are both loud and powerful. Like most Grob designs, the handle contains a sliver field generator and can be detached from the rest of the assembly. Sliver generators create a small, specialized cutting force screen that is aligned with the barrel of the weapon, effectively transforming it into a vicious melee tool.

The **Grob Blastergun** falls midway between a conventional rifle and a shotgun. It features an over/under combination of a burster tube and a light plasma cannon, both of them feeding off the same battery pack. Due to poor beam collimation, the plasma gun is shorter ranged but very powerful nonetheless.

The **Grob Heavy Blastergun** is basically a lighter version of the Repeating Plasma Gun. It lacks the latter's rapid-fire capacity but is much easier to wield. It suffers from the same beam collimation problem as its smaller brethren, however.

Game Use: All slicer weapons used in melee combat halve (round up) the Armor or Stamina rating of their target before calculating damage. The sliver field cannot be used to parry blows, though the gun can (effectively wrecking it as a firearm, however).

• Grob Blastergun

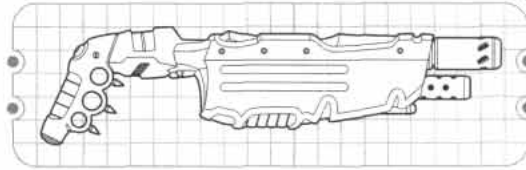

Silhouette CORE Stats:

ACC 0, DM x30, BR 5m, ROF 0, Plasma, Ammo 8, Wt. 3 kg

Plus ACC 0, DM x25, BR 15m, ROF 0, Piercing

Open Gaming Stats:

Dam. 2d10, Crit. (18-20), RI 10 ft, Plasma, Ammo 8, Wt. 3 kg

Plus Dam. 1d12+2, Crit. x3, RI 40 ft, Piercing

• Grob Heavy Blastergun

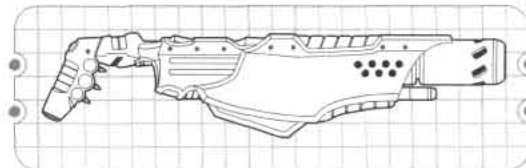

Silhouette CORE Stats:

ACC 0, DM x30, BR 20m, ROF 0, Plasma, Ammo 15, Wt. 3 kg

Open Gaming Stats:

Dam. 2d10, Crit. (18-20), RI 40 ft, Plasma

• Open Gaming Content

Grob sliver generators make a ranged weapon act like a normal, comparatively-sized melee weapon, adding +2 to the Threat Range and multiplying critical damage by two. The option doubles the cost of a ranged weapon.

• Grob Gunblades

Unlike the Grob Swrdgun, the gunblades are primarily melee weapons that are capable of functioning as short range weapons. A large ammunition power reserve is worn like a backpack. Grob technicians, to save time and effort, often reuse ammunition casing to house the battery packs.

The **Grob Waveblade** is a small but ingenious device that is similar to the weapons once employed by the civilization of Rut'ge'Ir (their star system was overrun a century ago by a D'vor Star Devourer and its escorts). Whether the Grobs copied the design or inspired themselves, no one knows, but it functions on similar principles. The gun is basically an extension of the sliver field principle: when activated, a resonance is set up within the field until some of the energy is bled off into a wave form projected forward along the blade.

The **Grob Featherblade** is a similar weapon but built slightly larger. It requires a secondary power feed to generate the main resonance effect, since all the primary energy feed is dedicated to maintaining the sliver field.

The **Grob Shearblade** is a cumbersome weapon that may have been originally designed as a tool. Two interlocking sliver fields are put over an articulated shearing blade activated by powerful linear motors. While the scissor action is slow and near impossible to use in combat, it's extremely powerful, capable of cutting through several centimeters of hardened alloy with ease.

• Grob Waveblade

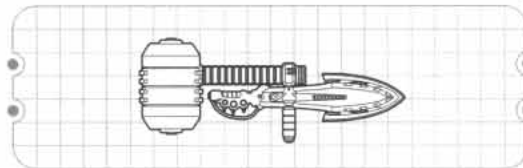

Silhouette CORE Stats:

ACC 0, DM x30, BR 5m, ROF 0, Plasma, Ammo 8, Wt. 3 kg

Open Gaming Stats:

Dam. 2d10, Crit. (18-20), RI 10 ft, Plasma, Ammo 8, Wt. 3 kg

• Grob Featherblade

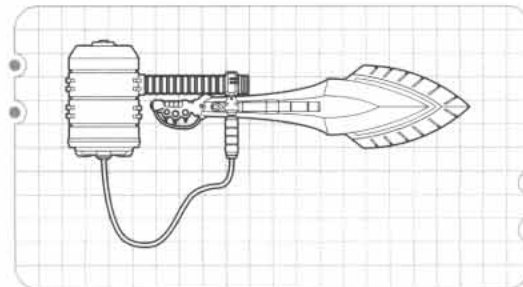

Silhouette CORE Stats:

ACC 0, DM x30, BR 5m, ROF 0, Plasma, Ammo 8, Wt. 3 kg

Open Gaming Stats:

Dam. 2d10, Crit. (18-20), RI 10 ft, Plasma, Ammo 8, Wt. 3 kg

• Grob Shearblade

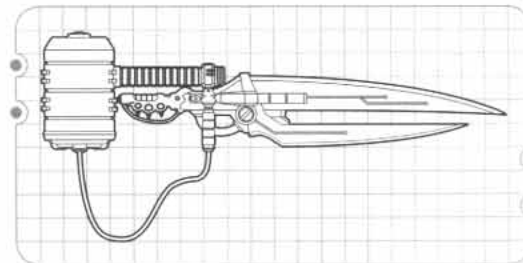

Silhouette CORE Stats:

ACC 0, DM x30, BR 5m, ROF 0, Plasma, Ammo 8, Wt. 3 kg

Open Gaming Stats:

Dam. 2d10, Crit. (18-20), RI 10 ft, Plasma, Ammo 8, Wt. 3 kg

● Grob Heavy Weapons

The Grobs tend to prefer weapons that are large and loud, but their diminutive physiology limits them in what they can pack. There are, however, a number of truly large personal guns in the Grob arsenal, though their costs and the amount of time required to make them limits their distribution within the various tribes.

The **Burster Snipergun** is very rare — most Grobs lack the patience to make effective use of such a long ranged weapon. It's basically a super-charged standard burster with a lengthened barrel and additional beam collimators. A sturdy stock and folding base make it quite stable when deployed.

The **Plasma Thrower** is a heavy area-denial weapon that is primarily used to defend the Grob's trade ships (especially against Zee attacks and raids). While cumbersome and short-ranged, it's very powerful. Each of the four shells contain a potent chemical fuel mixture. When the weapon is triggered, a high intensity ion discharge is sent through the material as it is vaporized within the heavily insulated muzzle. The resulting reaction creates a belching cloud of high temperature plasma that can burn through almost anything, though it dissipates rapidly.

The **Multi-Rocket Launcher** is an eight-rocket device intended for area bombardment. The rockets' miniature plasma drives are ignited by a high-intensity current fed through a standard power backpack.

● Burster Snipergun

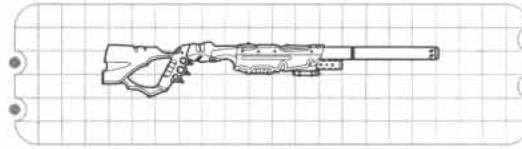

Silhouette CORE Stats:

ACC 0, DM x30, BR 5m, ROF 0, Plasma, Ammo 8, Wt. 3 kg

Open Gaming Stats:

Dam. 2d10, Crit. (18-20), RI 10 ft, Plasma, Ammo 8, Wt. 3 kg

● Plasma Thrower

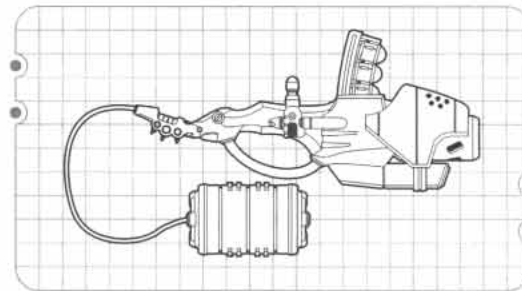

Silhouette CORE Stats:

ACC 0, DM x30, BR 5m, ROF 0, Plasma, Ammo 8, Wt. 3 kg

Open Gaming Stats:

Dam. 2d10, Crit. (18-20), RI 10 ft, Plasma, Ammo 8, Wt. 3 kg

● Multi-rocket Launcher

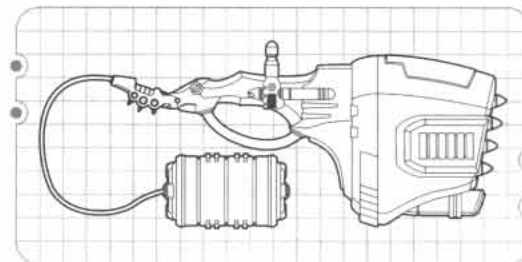

Silhouette CORE Stats:

ACC 0, DM x30, BR 5m, ROF 0, Plasma, Ammo 8, Wt. 3 kg

Open Gaming Stats:

Dam. 2d10, Crit. (18-20), RI 10 ft, Plasma, Ammo 8, Wt. 3 kg

• Hiscan Missile Launchers

The Hiscans have developed only a small number of advanced weapons on their own (having few dry workshops where they can work on them). They usually prefer to buy them from other races. The one major exception are the various Hiscan high-velocity missile launcher, a curious type of weapon that can be used both under and above water.

The device uses a high density gravitic field to accelerate a projectile to very high speed. The field is initiated within an implosion chamber located at the top of the weapon, then further amplified through a gravitic coil before being discharged through a pair of wave guides located on each side of the launch tube. This propels the missile toward the target and provides the required boost to ignite a plasma reaction within the warhead, enveloping it in a shroud of plasma that pushes aside water or air and allows it to move at velocities in excess of Mach 25.

While the missile has a very flat trajectory and its time to most targets is usually near zero. The projectile loses speed rapidly, however, and the gravity waves tend to ripple, imparting a slight wobble to the projectile. These factors cancel one another, making the launcher's accuracy only average.

The **Type A Launcher** is the simplest design, and can launch only one missile at a time. It needs to be reloaded between shots by inserting a new missile within the launch tube.

The **Type B Launcher** is similar in that it can launch only one missile at a time, but it features an improved implosion chamber that provide a greater initial impulsion.

The **Type C Launcher** is the most advanced version seen thus far. A large implosion chamber and a complex launch tube arrangement allows it to hold four missiles in a ready state, though only one can be fired at once.

• Type A Launcher

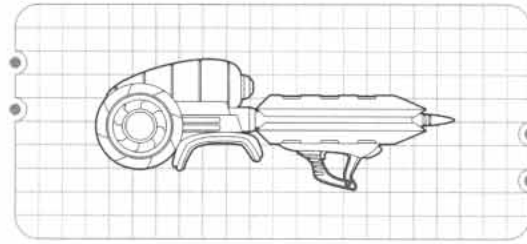

Silhouette CORE Stats:

ACC 0, DM x50, BR 100m, ROF 0/1, Armor-Piercing, Ammo 1, Wt. 4 kg

Open Gaming Stats:

Dam. 3d12, Crit. (18-20), RI 110 ft, Piercing, Ammo 1, Wt. 4 kg

• Type B Launcher

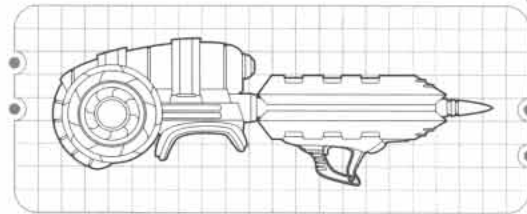

Silhouette CORE Stats:

ACC 0, DM x65, BR 150m, ROF 0/1, Armor-Piercing, Ammo 1, Wt. 5 kg

Open Gaming Stats:

Dam. 4d12, Crit. (18-20), RI 160 ft, Piercing, Ammo 1, Wt. 4 kg

• Type C Launcher

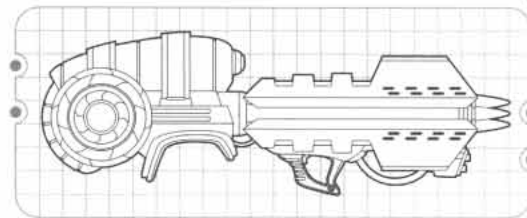

Silhouette CORE Stats:

ACC 0, DM x65, BR 150m, ROF 0/2, Armor-Piercing, Ammo 4, Wt. 7 kg

Open Gaming Stats:

Dam. 4d12, Crit. (18-20), RI 160 ft, Piercing, Ammo 4, Wt. 4 kg

● Kabayan Flaming Lances

The Kabayans have a fondness for weapons that need to be used at close range. Their Flaming Lances are powerful plasma burners intended for ship-to-ship boarding actions and other types of combat in restricted places. Like most Kabayan weapon designs, flaming lances are fairly simple devices, composed of a plasma injector linked to a simple magnetic accelerator. The raw fuel is carried within an armored canister that can be worn as a backpack or strapped to the side of the leg.

The Light Flaming Lance is the most basic model. It's capable of throwing a sheet of scalding flames several dozens of meters away.

The Triple Flaming Lance is a variant that straps three tubes together in an inverted triangle. This weapon has more output and covers more area, but it suffers from a greatly reduced ammunition capacity. It's most often seen at the front of Kabayan assaults, where the bearer has a short life expectancy and must inflict the most damage possible in a short amount of time.

The Heavy Flaming Lance simply scales up the design of its lighter brethren. While the weapon suffers from a similar lack of autonomy as the previous one, it's somewhat longer ranged.

● Light Flaming Lance

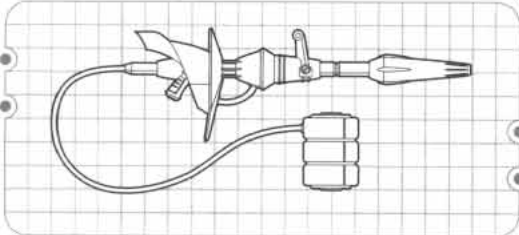

Silhouette CORE Stats:

ACC 0, DM x15, BR 5m, ROF 0, Incendiary, Persistent, Wide-Angle (10), Ammo 12, Wt. 4 kg

Open Gaming Stats:

Dam. 2d6, RI 20 ft, Fire, Cone, Ammo 12, Wt. 4 kg

● Triple Flaming Lance

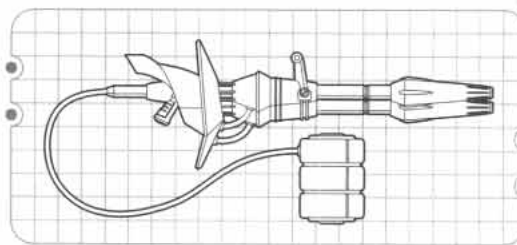

Silhouette CORE Stats:

ACC 0, DM x30, BR 5m, ROF 0, Incendiary, Persistent, Wide-Angle (10), Ammo 4, Wt. 6 kg

Open Gaming Stats:

Dam. 2d10, RI 20 ft, Fire, Cone, Ammo 4, Wt. 6 kg

● Heavy Flaming Lance

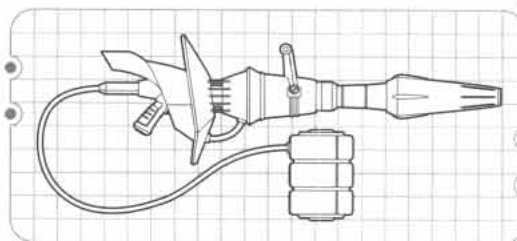

Silhouette CORE Stats:

ACC +1, DM x20, BR 10m, ROF 0, Incendiary, Persistent, Wide-Angle (10), Ammo 8, Wt. 6 kg

Open Gaming Stats:

Dam. 2d6+2, RI 30 ft, Fire, Cone, Ammo 8, Wt. 6 kg

● Kabayan Halberds

The Kabayans' preference for melee combat has led them to develop (or, more properly, to push someone smaller than they are to design and develop) a whole range of close combat weaponry. In addition to the common firesheet blades, many Kabayans like to carry powered halberds in combat. While they are too unwieldy to be used for parrying, they give a good reach (+1 meter) to the bearer.

These are massive ax-like weapons that are wielded in two hands. A generator placed within the shaft connects to the blade, making it hum and crackle with the glow of barely contained energy. Whenever the halberd strikes something, sparks and electrical discharges fly about and the air fills with the smell of ozone.

The standard **Powered Halberd** is around two meters long, with large blades jutting out of either side. Their mass is balanced by the powerpack located at the base of the shaft. Some higher ranking Kabayans have been known to put engravings on the blade to indicate their status.

The **Light Flaming Halberd** is similar to the previous model, but with a twist: the head of the shaft incorporates a miniature flaming lance at its tip, between the blade. While its power and ammunition capacity are both somewhat small, the element of surprise has led many to their downfall.

The **Heavy Flaming Halberd** also includes a flaming lance, but this time a full-sized one. It's a monster of a weapon, usually wielded only by the largest and meanest Kabayans. Its mass makes it cumbersome, and only a skilled fighter will be able to use it effectively.

● Powered Halberd

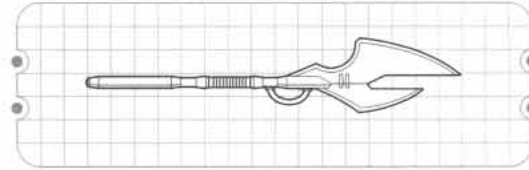

Silhouette CORE Stats:

ACC 0, DM x15, Melee, Wt. 4 kg

Open Gaming Stats:

Dam. 2d6, Melee, Slashing, Wt. 4 kg

● Light Flaming Halberd

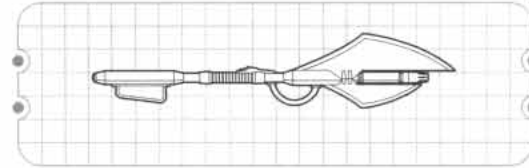

Silhouette CORE Stats:

ACC 0, DM x15, Melee, ROF 0, Wt. 4 kg

Plus ACC 0, DM x10, BR 2m, ROF 0, Incendiary, Persistent, Wide-Angle (10), Ammo 3

Open Gaming Stats:

Dam. 2d6, Melee, Slashing, Wt. 4 kg

Plus Dam. 2d4, RI 10 ft, Fire, Cone, Ammo 3, Wt. 4 kg

● Heavy Flaming Halberd

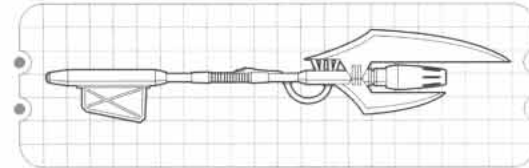

Silhouette CORE Stats:

ACC 0, DM x20, Melee, ROF 0, Wt. 5 kg

Plus ACC 0, DM x15, BR 5m, ROF 0, Incendiary, Persistent, Wide-Angle (10), Ammo 12

Open Gaming Stats:

Dam. 2d6, Melee, Slashing, Wt. 5 kg

Plus Dam. 2d6, RI 20 ft, Fire, Cone, Ammo 12

● Kabayan MonoSpears

Most Kabayans lack the influence or power to acquire truly effective weapons, and must thus make do with inferior ones. It is widely believed that the first MonoSpears were born out of that desperation, as one Kabayan took salvaged hull alloy to make a spear. The hard poly-carbo-ceralmetal alloy could be sharpened down to a few molecules' thickness on the edge while retaining all its strength, making it a superb cutting tool. The problem, of course, is finding the required hull alloy grinder that can perform this operation.

The **MonoSpear** is the basic weapon of this type. Usually, the head and shaft are balanced so that the spear can be used as a thrown weapon. Samples have been observed in virtually all sizable Kabayan groups encountered thus far across the entire front of the Spiral galaxy. Incidences of spotting is higher in areas where battles recently took place, as the salvaged alloy is easier to find.

The **MonoLance** is a step up from the previous design. In addition to the wide alloy blade, the weapon incorporates some webbing reinforcements that allows it to be used for parrying incoming blows and blasts. The shaft is longer and balanced to help in this function.

The **Flaming MonoLance** has been observed only twice within the past century. This unusual weapon combines a light flaming lance with a MonoLance. One can only theorize that either the Kabayan came across a spare lance, or perhaps was very attached to his previous weapon and chose to have it upgraded instead of changed wholesale.

● MonoSpear

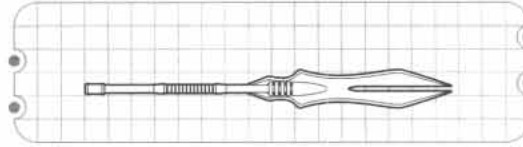

Silhouette CORE Stats:

ACC 0, DM x15, Melee/Throw, Armor-Crushing*, Wt. 3 kg

*Subtract two points of Armor from machines; cause two wounds if used against a living target.

Open Gaming Stats:

Dam. 2d6, Crit. x 2, Melee/Throw, Slashing, Wt. 3 kg

● MonoLance

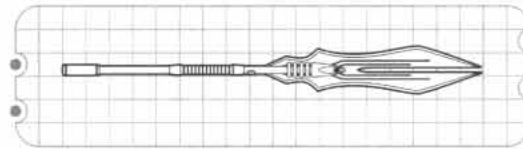

Silhouette CORE Stats:

ACC 0, DM x15, Melee, Armor-Crushing, Defensive, Wt. 4 kg

Open Gaming Stats:

Dam. 2d6, Crit. x 2, Melee, Slashing, Parry +3, Wt. 4 kg

● Flaming MonoLance

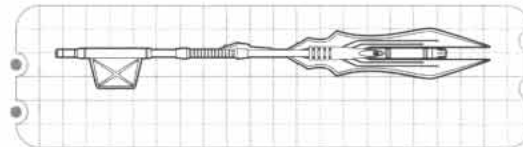

Silhouette CORE Stats:

ACC 0, DM x15, Melee, Armor-Crushing, Defensive, Wt. 5 kg

Plus ACC 0, DM x10, BR 2m, ROF 0, Incendiary, Persistent, Wide-Angle (10), Ammo 3

Open Gaming Stats:

Dam. 2d6, Crit. x 2, Melee, Slashing, Parry +3, Wt. 4 kg

Plus Dam. 2d4, RI 10 ft, Fire, Cone, Ammo 3, Wt. 4 kg

• Hiscan Dancing-Blades

Another of the few native weapon types produced by the Hiscan civilization, the Dancing-Blades (also sometimes known by their Hiscan name, *Sask-Rass*) are extremely sharp, well-balanced implements of death. While they are extremely hard to use properly, requiring much practice in their handling, they can be devastating in the right hands.

The **Saskan** is a scimitar-like blade that is wielded in one hand. While it can be used like a standard short sword, its peculiar balance and curved shape require smooth, arc-like motions that are hard to master but extremely elegant and efficient. A true *Sask-Rass* master bears two saskans, using each to cover an entire 180-degree arc on either side.

The **Saskatur** is a larger and comparatively heavier, though both the shape and forging of the blade take this into account. While the saskatur has only one handle, it's intended to be used two-handed: the second arm glides across the surface of the weapon, supporting it and redirecting it toward the target(s). Needless to say, this requires some training, and the sharpness of the blade make any mishap dangerous.

The **Saskator** is the largest Hiscan blade, and the hardest to use. Like the saskatur, it's held in one hand, with the second hand dancing across the surface. The blade is reinforced and quite solid, and can be used to parry almost any type of attack without damage — a true *Sak-Rass* master deflects the energy down the length of the blade, literally "pouring it" away.

• Requirements and Special Rules

SiICORE: Using a Dancing-Blade is a Melee task with an associated Cpx. On a Fumble, roll a Defense test versus the attack: if failed, a wound is self-inflicted.

OGL: Requires an Exotic Weapon Proficiency in order to use. If an attack misses by more than 10, make a Defense roll against it; if failed, take damage.

• Saskan

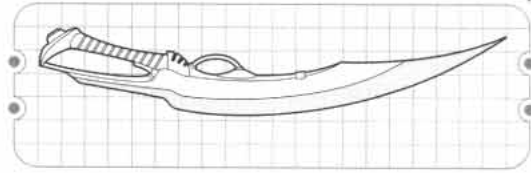

Silhouette CORE Stats:

Cpx 2, ACC +1, DM x10, Melee, Armor-Crushing*, Wt. 1 kg

Open Gaming Stats:

Equipment Bonus +2, Dam. 2d4, Crit. x 2, Melee, Slashing, Wt. 1 kg

• Saskatur

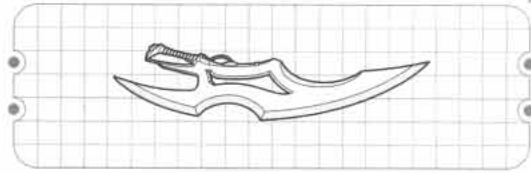

Silhouette CORE Stats:

Cpx 3, ACC +1, DM x14, Melee, Armor-Crushing, Wt. 1.5 kg

Open Gaming Stats:

Equipment Bonus +2, Dam. 2d4+1, Crit. x 2, Melee, Slashing, Wt. 1.5 kg

• Saskator

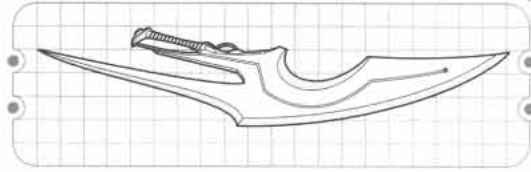

Silhouette CORE Stats:

Cpx 4, ACC +1, DM x16, Melee, Armor-Crushing, Defensive, Wt. 2 kg

Open Gaming Stats:

Equipment Bonus +2, Dam. 2d6, Crit. x 3, Melee, Slashing, Parry +3, Wt. 2 kg

● Kom'Sov Combat Gauntlets

While the Kom'Sov are an aggressive species, the average constituent (Kom'Sov citizen), while very quick on its feet, isn't very tough. For that reason, the Kom'Sov scientists have made sure their troops are equipped with weaponry that compensates for this perceived weakness. The Combat Gauntlets are one such piece of armament: they cover and protect a trooper's hands while providing him with additional hitting strength and overall firepower. They also allow the wearer to carry items, including other weapons (though of course the gauntlets cannot be used while holding something).

The **Melee Gauntlet** is the simplest device. It's usually worn on the user's off-hand, where it can be used to support the main weapon and be brought to bear quickly if close combat occurs. It consists of a heavily poly-alloy glove with a built-in shockwave generator. The contact plate of the latter is located across the fist. Whenever the gauntlet is activated and struck against something, the generator discharges, sending a pressure wave that resonates through the target.

The **Laser Gauntlet** is similar but uses the generator to power a laser unit. The beam has several power settings and acts in many ways like a standard laser rifle (see **CORE Command Player's Handbook**).

The **Gatling Gauntlet** holds a stubby but powerful repeating energy cannon. Its massive energy needs require the presence of an additional power pack that is attached to the glove by a large, flexible power coil. Even then, it rapidly exhausts its ammunition load when fired at full speed.

● Requirements and Special Rules

SilCORE: The Gauntlet provides Armor 15 on the lower arms only. It requires a Specialization in Small Arms to use, or else is Cpx 2.

OGL: The Gauntlet provides a +3 armor equipment bonus. It requires its own Exotic Weapon Proficiency to use.

● Melee Gauntlet

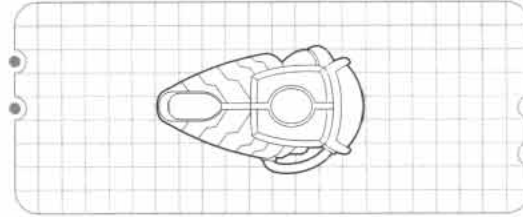

Silhouette CORE Stats:

ACC 0, DM x6, Melee, Persistent, Wt. 1 kg

Open Gaming Stats:

Dam. 1d6/1d3/1 (first hit, then successive rounds),
Melee, Crushing, Wt. 1 kg

● Laser Gauntlet

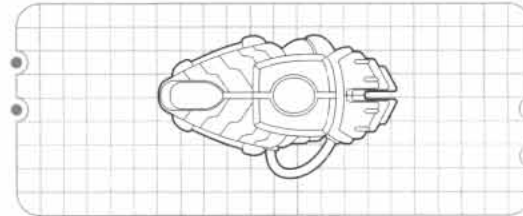

Silhouette CORE Stats:

Acc +1, DM x10/15/25*, BR 120 m, ROF 0, Ammo 30, Wt. 1.5 kg

Open Gaming Stats:

Dam 2d4/6/8*, RI 150ft, Laser, Ammo 30, Wt. 1.5 kg

*Depends on power (ammo) consumption: 1/3/9

● Gatling Gauntlet

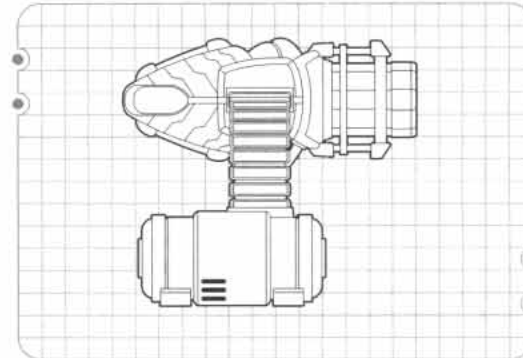

Silhouette CORE Stats:

Acc -1, DM x25/30*, BR 30 m, ROF +2, Ammo 120, Wt. 2.5 kg

Open Gaming Stats:

Dam 2d8/10*, RI 30ft, Laser, Automatic, Ammo 120, Wt. 2.5 kg

*Depends on power (ammo) consumption: 3/9 (plus
ROF consumption)

OPEN GAMING LICENSE

OPEN GAME LICENSE Version 1.0

The following text is the property of Wizards of the Coast, Inc. and is Copyright 2000 Wizards of the Coast, Inc ("Wizards"). All Rights Reserved.

1. Definitions: (a) "Contributors" means the copyright and/or trademark owners who have contributed Open Game Content; (b) "Derivative Material" means copyrighted material including derivative works and translations (including into other computer languages), potation, modification, correction, addition, extension, upgrade, improvement, compilation, abridgment or other form in which an existing work may be recast, transformed or adapted; (c) "Distribute" means to reproduce, license, rent, lease, sell, broadcast, publicly display, transmit or otherwise distribute; (d) "Open Game Content" means the game mechanic and includes the methods, procedures, processes and routines to the extent such content does not embody the Product Identity and is an enhancement over the prior art and any additional content clearly identified as Open Game Content by the Contributor, and means any work covered by this License, including translations and derivative works under copyright law, but specifically excludes Product Identity. (e) "Product Identity" means product and product line names, logos and identifying marks including trade dress; artifacts; creatures characters; stories, storylines, plots, thematic elements, dialogue, incidents, language, artwork, symbols, designs, depictions, likenesses, formats, poses, concepts, themes and graphic, photographic and other visual or audio representations; names and descriptions of characters, spells, enchantments, personalities, teams, personas, likenesses and special abilities; places, locations, environments, creatures, equipment, magical or supernatural abilities or effects, logos, symbols, or graphic designs; and any other trademark or registered trademark clearly identified as Product identity by the owner of the Product Identity, and which specifically excludes the Open Game Content; (f) "Trademark" means the logos, names, mark, sign, motto, designs that are used by a Contributor to identify itself or its products or the associated products contributed to the Open Game License by the Contributor (g) "Use", "Used" or "Using" means to use, Distribute, copy, edit, format, modify, translate and otherwise create Derivative Material of Open Game Content. (h) "You" or "Your" means the licensee in terms of this agreement.

2. The License: This License applies to any Open Game Content that contains a notice indicating that the Open Game Content may only be Used under and in terms of this License. You must affix such a notice to any Open Game Content that you Use. No terms may be added to or subtracted from this License except as described by the License itself. No other terms or conditions may be applied to any Open Game Content distributed using this License.

3. Offer and Acceptance: By Using the Open Game Content You indicate Your acceptance of the terms of this License.

4. Grant and Consideration: In consideration for agreeing to use this License, the Contributors grant You a perpetual, worldwide, royalty-free, non-exclusive license with the exact terms of this License to Use, the Open Game Content.

5. Representation of Authority to Contribute: If You are contributing original material as Open Game Content, You

represent that Your Contributions are Your original creation and/or You have sufficient rights to grant the rights conveyed by this License.

6. Notice of License Copyright: You must update the COPYRIGHT NOTICE portion of this License to include the exact text of the COPYRIGHT NOTICE of any Open Game Content You are copying, modifying or distributing, and You must add the title, the copyright date, and the copyright holder's name to the COPYRIGHT NOTICE of any original Open Game Content you Distribute.

7. Use of Product Identity: You agree not to Use any Product Identity, including as an indication as to compatibility, except as expressly licensed in another, independent Agreement with the owner of each element of that Product Identity. You agree not to indicate compatibility or co-adaptability with any Trademark or Registered Trademark in conjunction with a work containing Open Game Content except as expressly licensed in another, independent Agreement with the owner of such Trademark or Registered Trademark. The use of any Product Identity in Open Game Content does not constitute a challenge to the ownership of that Product Identity. The owner of any Product Identity used in Open Game Content shall retain all rights, title and interest in and to that Product Identity.

8. Identification: If you distribute Open Game Content You must clearly indicate which portions of the work that you are distributing are Open Game Content.

9. Updating the License: Wizards or its designated Agents may publish updated versions of this License. You may use any authorized version of this License to copy, modify and distribute any Open Game Content originally distributed under any version of this License.

10. Copy of this License: You MUST include a copy of this License with every copy of the Open Game Content You Distribute.

11. Use of Contributor Credits: You may not market or advertise the Open Game Content using the name of any Contributor unless You have written permission from the Contributor to do so.

12. Inability to Comply: If it is impossible for You to comply with any of the terms of this License with respect to some or all of the Open Game Content due to statute, judicial order, or governmental regulation then You may not Use any Open Game Material so affected.

13. Termination: This License will terminate automatically if You fail to comply with all terms herein and fail to cure such breach within 30 days of becoming aware of the breach. All sublicenses shall survive the termination of this License.

14. Reformation: If any provision of this License is held to be unenforceable, such provision shall be reformed only to the extent necessary to make it enforceable.

15. COPYRIGHT NOTICE

Open Game License v 1.0 Copyright 2000, Wizards of the Coast, Inc.

System Reference Document (draft version) Copyright 1999, 2000, Wizards of the Coast, Inc.

CORE  **COMMAND**

BIG NASTY ALIENS

The universe is not a safe place!

"Big Nasty Aliens" features a huge number of new sentient races and assorted creatures for the CORE Command universe, ranging from tiny (yet deadly) critters all the way to the giant planet-sized D'vor Stellar Devourer. The book also offers several artifacts and constructs found in ruins and enemy armies throughout the Five Galaxies, plus ten pages of new weapons, tools and specialized equipment. This manual also contains game tips and adventure seeds.

Requires the use of the Silhouette CORE rulebook(tm) published by Dream Pod 9, Inc., or a Roleplaying Game Core Book published by Wizards of the Coast(R), Inc.

DP9-904



WWW.DP9.COM



Printed in Canada

DREAM POD 9