

# BATTLELORDS™ OF THE TWENTY-THIRD CENTURY



ROLEPLAYING IN A DANGEROUS FUTURE

# BATTLELORDS

## OF THE 23rd CENTURY

*A product of Optimus Design Systems*

### BASIC RULES BOOK THIRD EDITION



Written By: Lawrence R Sims  
Chief Artist: Michael Osadciw  
Cover Design: Michael Osadciw  
Cover Art: Rob Prior  
Contributing Artists: James Carlton  
Andrew Moore  
Technical Advisers: Louis Norton  
Mike Wagner  
Editors: David P. Wagner Jr.  
Louis Norton  
Doug Nelson  
Donald Stefanie II  
Type Setting: John McDougal  
David P. Wagner Jr.  
Blind Test: Jon Metcalf  
Our Hero: Mark Peiffer



Play Testers: Ronald Trackey, Sandford Berenberg, Ernie Freiberg, Alex Bonafice, Larry "Foto" Fein, Brett Miller, Michael Tinsmon, Brent Osgood, Jon Baker, Michael Hausladen, Michael Hausladen, Daniel Kowalski, Matt Kolokowsky, William Mayer, Christian Martin, Rob Goodfellow, Benjamin Pierce, The Mega-Mercs, Mark Falsone, Psycho, Lou, Dan Mooney, Fetus, Paul "Mouse" Knaus, JP, Eric Polovich, Jamie Grimes, Jerry Alexandrotos, Kristin Newer, Leigh Abel, Doug "The Love Machine" Nelson, Jeff "House Bitch" Wheeler, The Conservatives: Don Stefanie, Mike Wagner, Eric Wood, Dave "Chaos Bane" Wagner, Glen "The Radical" McDole, and all the other certifiable nuts who put up with me during the design phase.

**Special Thanks To:** All of you gamers who bought the earlier editions and supported the Battlelords of the 23rd Century system. Without your commitment, none of this would have been possible.  
May your dice never roll double ZODDS.

To Mr. Sims: If I measure up to half the man you are, then I will have accomplished much in my life.  
You are my number one Guru and always will be. I love you very much Dad!

To God: Thank you for giving me the strength to tackle this, the toughest of endeavors.

## THE BACK TO THE BASICS PHILOSOPHY

We at Optimus Design Systems have developed what we call the "Back to the Basics" philosophy on gaming. We believe in putting out powerful information systems, packed with excellent art work, and lots of reading material, at a reasonable price. You have my word as author and designer that these basic principles will never change!

Sincerely Yours,

  
Lawrence R Sims

For those of you who have questions, suggestions, deranged thoughts, mad desires to buy 5000 copies of this book, or simply something on your mind, feel free to write to us at:



**Optimus Design Systems**  
P.O. Box 1511  
Buffalo, New York 14215

This book was designed as a game. The information portrayed doesn't in any way reflect the beliefs of the author or company. We don't support cannibalism, racism, sexism, and/or any other "ism" that has negative social consequences. It is suggested reading for ages 14 and older.

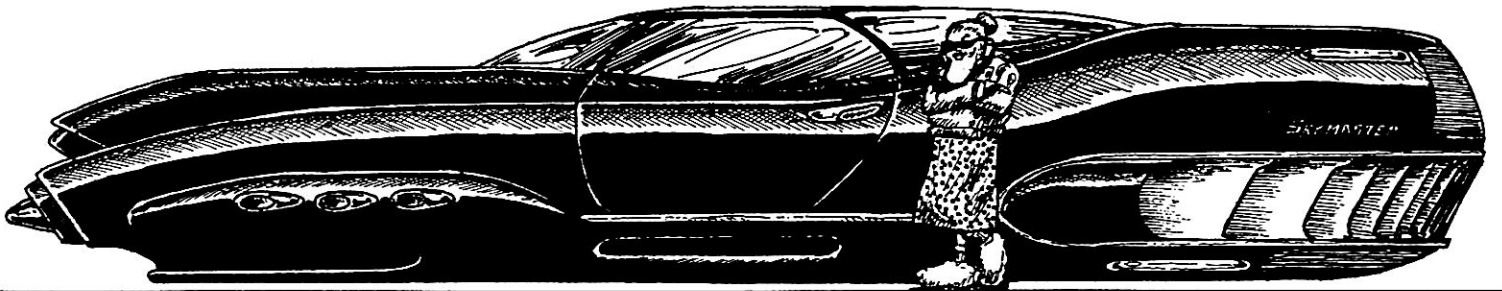

Revised Third Printing

Copyright 1990,1991, and 1992 by Lawrence R Sims. Any reproduction or unauthorized use of this work, without the written permission of the author or Optimus Design Systems is prohibited. Printed in the USA.

## TABLE OF CONTENTS

CREDITS .....	1	Racial Monetary Distribution .....	52
BACK TO BASICS PHILOSOPHY .....	2	Primary Occupation .....	53
TABLE OF CONTENTS .....	3	Secondary Occupation .....	53
INTRODUCTION .....	7	Experience Points .....	53
QUICK START .....	9	Experience Points Available .....	53
PICTORIAL REPRESENTATION .....	10	Languages .....	53
THE GALACTIC TIME TABLE .....	13	Sponsors .....	53
<b>STARTING THE GAME</b>			
CHARACTER GENERATION .....	15	Salary .....	54
For the Bold, Strong, and the Curious .....	15	Rank .....	55
Starting Equipment .....	15	Awards .....	55
The Character Sheet .....	15	Black Marks .....	55
Important Terms .....	15	The Survival Matrix Roll .....	55
VITAL STATISTICS GENERATION .....	15	I Was Just Growing Up Tables .....	55
Strength .....	16	Fickle Finger of Fate Tables .....	56
Manual Dexterity .....	16	<b>OCCUPATIONAL SKILLS</b>	
I.Q. ....	16	Beginning Skills .....	59
Agility .....	16	Starting Proficiency Points .....	59
Constitution .....	16	Occupational Proficiency .....	59
Aggression .....	16	Primary Occupational Skills .....	59
Intuition .....	16	Secondary Occupational Skills .....	59
Charisma .....	17	Expertise in a Field .....	59
SECONDARY STATISTICS .....	17	Mastery in a Field .....	59
Terrestrial Knowledge .....	17	Defaults .....	59
Military Leadership .....	17	Time to Perform a Task .....	60
Persuasion .....	17	Learning New Levels .....	60
Bargaining .....	17	Proficiency Cost .....	60
VITAL STATISTIC TABLES .....	17	Levels of Difficulty .....	60
Strength .....	17	Using Multiple Skills .....	60
Strength Limitations Table .....	17	Racial Limitations .....	60
Manual Dexterity .....	17	Occupational Skills Table .....	61
I.Q. ....	18	Physical Skills .....	64
Agility .....	18	Occupational Skills .....	65
Constitution .....	18	Alien Technology .....	65
Intuition .....	18	Arts and Craft .....	65
Charisma .....	19	Communications .....	65
Statistics Comparison Tables .....	19	Computers .....	65
Racial Preferences .....	19	Cybernetics .....	66
<b>CHARACTER RACES</b>			
Chatilian Empath .....	20	Deep Space Operations .....	66
Cizerack .....	22	Engineering .....	66
Eridani .....	25	Espionage .....	68
Gen-Human .....	27	Journeyman Skills .....	68
Human .....	29	Medical Treatment .....	68
Mazian Changeling .....	31	Military Skills .....	69
Mutzachan .....	34	Robotics .....	70
Orion Rogue .....	36	Sciences .....	70
Phentari .....	38	Security Systems .....	70
Python Lizard .....	41	Vehicles .....	71
Ram Python .....	43	Gunnery .....	71
Zen Rigeln Healer .....	45	Weapons .....	71
<b>CHARACTER GENERATION</b>			
SETTING UP THE BASICS .....	48	Miscellaneous Studies .....	71
Name .....	48	Languages .....	72
Race .....	48	<b>BODY ARMOR</b>	
Height and Weight .....	48	Armor Integrity .....	73
Size Class .....	48	Threshold .....	73
Body Points .....	48	Absorption Rating .....	73
Movement .....	48	Encumbrance .....	73
Number of Attacks .....	48	Key To Armor Table .....	73
Damage per Attack .....	49	Critical Hits (Armor) .....	75
Vision .....	49	Armor Options .....	75
Smell .....	49	Effect of Weapons Hits .....	75
Hearing .....	49	Damage Allocation .....	75
Planet of Origin .....	49	Armor Tables .....	76
Honor .....	51	Body Defense Suits .....	77
Alignment .....	51	Helmets .....	81
Social Status .....	52	Mars Systems .....	82
		Ties .....	82
		Armor Options .....	83

<b>HAND WEAPONS</b>	
Equipment Chart .....	86
Archaic Hand Held Weapons .....	94
Archaic Powder Weapons .....	96
Pistols .....	96
Rifles .....	97
Submachine Guns .....	97
Shotguns .....	98
Machine Guns .....	98
Beam Weapons .....	98
Laser Pistols .....	98
Laser Rifles and Carbines .....	99
Impact Lasers .....	99
Machine Gun Lasers .....	100
Pulse Weapons .....	100
Omega Cannons .....	101
Particle Weapons .....	102
Metal Guns .....	102
Mag Guns .....	102
Disruptors .....	103
Disintegrators .....	104
Meson Cannons .....	104
Flamethrowers .....	104
Rocket Launchers .....	104
Anti-Tank Weapons .....	104
Personal Missile Systems .....	105
Accessories .....	106
Ammunition .....	106
Mortars .....	106
Specialized Weaponry .....	107
Grenade Launchers .....	108
Grenades .....	108
Mines .....	110
Explosives .....	110
<b>MISCELLANEOUS EQUIPMENT</b>	
Detection Equipment .....	111
Espionage Equipment .....	112
Medical Gear .....	113
Personal Equipment .....	114
Environmental Hazard Gear .....	116
Communications Equipment .....	116
<b>COMBAT</b>	
The Draw .....	118
Initiative .....	118
Establishing Good Aim .....	118
Rate of Fire .....	118
Determining a Hit .....	118
How Many Shots Hit .....	118
Hit Location .....	119
Automatic Fire .....	118
Spread Fire .....	119
Confined Fire .....	119
Snap Shots .....	119
Mass Incoming Fire .....	120
Called Shots .....	120
Suppression .....	120
Changing Targets .....	120
Reloading .....	120
Malfunctions .....	120
Combat Movement .....	121
Cover and Concealment .....	121
Critical Hits .....	121
Archaic Hand Weapon Combat .....	121
Hand to Hand Combat .....	122
Grappling .....	122
Defender Options .....	123
Miscellaneous Combat Information .....	123
The Survival Matrix Roll .....	124
Matrix Combat .....	124
Combat Tactics .....	124

Patrols .....	124
Camouflage .....	124
Guard Duty .....	124
Military Abbreviations .....	125
Use of Hand Radios .....	125
Never and Always .....	125
Making Good Defensive Positions .....	125
Mortality .....	126
The Effects of Diseases .....	127
Replacing Limbs .....	127

**BIONICS**

The Effects on Constitution .....	128
Construction Cost .....	128
Construction Budget .....	128
Allocation of Space .....	128
System Enhancement .....	128
Cybernetic Ear Implants .....	130
Cybernetic Optical Implants .....	130
Sensory Units .....	130
Foot Implants .....	130
Hand Implants .....	130
Bionic Hand and Arm Weapons .....	131
Body Enhancement Units .....	131
Skull Enhancement Units .....	132
Implants .....	132

**VEHICLES**

Lend Lease .....	134
Movement .....	134
Crew .....	134
Fuel Cost .....	134
Cargo .....	134
Threshold .....	134
ECM .....	134
ECCM .....	134
Flux Shields .....	134
Integrity .....	134
Attack Modifier .....	134
Critical Hits to Personnel .....	134
Critical Hits to Systems .....	136
Vehicle Combat .....	136
Vehicle vs Vehicle Combat .....	136
Random Orientation .....	136
Initiative .....	136
Attack Number .....	136
Gunnery Range Brackets .....	136
Application of Gunnery Skill .....	136
Automobiles .....	136
Military Vehicles .....	138
Combat Shuttles .....	139
Pleasure Craft .....	139
Skimmers .....	139
Hoppers .....	140
Transcruisers .....	140
Starcruisers .....	140
Robots .....	142
Defense Systems .....	143
Heavy Weapon Systems .....	143
Description of Play .....	144

**LIVING IN THE FUTURE**

The Alliance .....	145
The Galactic Forces .....	145
Corporations .....	145
Company Guys .....	147
The Rebels .....	147
Spies .....	147
The Arachnid Presence .....	148
Pirates .....	148

Bounty Hunters	148	Experience Points	207
Common Folk	148	Vital Statistics Checks	207
Hirelings	148	Secondary Skills Checks	208
Mercenary Groups	148	Occupational Skills Checks	208
The Black Market	151	Combat	208
Survival in the City	151	Critical Hits	209
City Types	151	Wound Recovery Table	210
Spaceports	151	Healing	210
Buildings	154	Traps	210
Zones of Control	154	Learning New Powers	210
The Right to Say No	154	Non Player Characters	210
Police Activities	154	Random Encounters	211
Galactic Law	154	Time	212
Money	155	Food	212
Cost of Living	155	Water	212
Temporary Lodging	155	Sleep	212
Permanent Lodging	155	Monsters	212
The Galactic Grocery Store	156	Structures	217
Food for the Palate	157	Treasure	218
Pets	157	Trade Items	218
The Bar Scene	162	Encumbrance	218
Madd Mike's Mercenary Brochure	162	Communication	218
Cyball	162	Light	219
Heros and Villains	162	Infravision	219
The Duel	163	Night Vision	219
Galactic Newsmen	163	Ultra-Vision	219
No Nukes	163	Movement	219
Rent-a-Skill	165	Finding the Treasure Stash	219
Clonic Production	165	Power Units	221
DNA Masking	165	Regional Offices	221
Plastic Surgery	165	The Boss	221
Quarantines	165	Rapid Decompression	222
Customs	165	Malfunctions	222
Defense Nets	165	Prestige	223
Weapons Control	166	Rank	223
Smuggling	166	Calculating Promotion Points	225
Credit Cards	168	Salary vs Grade	225
Getting Around the Galaxy	168	Officers	225
People Places and Things	168	Effects of Black Marks on Promotion	225
Galactic Phenomena	169	Medals and Commendations	225
Motaran Rift	170	The Company Uniform	228
Tech Levels	170	Contacts	228
The Final Frontier	170	Starting Contacts	228
Fornax Sector Map	171	Distribution of Network Contacts	229
Andromeda Sector Map	173	Frontier Networks	229
Inner Circle Star Map	175	Government Networks	229
Local Group Star Map	177	Legal Networks	229
Map Legend	178	Value of the Network	229
<b>SPECIAL POWERS</b>			
Starting Powers	179	Maintaining a Network	229
Energy Brackets	179	Increasing Network Strength	230
Power Points	179	Priming a Network	230
Experience and Power Generation	179	Establishing New Contacts	230
Colors and Titles	179	Ionic Storms	230
Gaining New Powers	179	The Clamp Down	230
Duration	179	Network Ties to the Black Market	230
Generation Time	179	Mail Service	230
Boosting	179	Masnrock Generator	230
Specialization	179	The Phone Bill From Hell	230
Latent Extraction	180	Availability of Items	232
Survival Matrix Rolls	180	GENERAL COMBAT REFERENCE TABLES	237
Special Powers Lists	180	THE QUICK COMBAT REFERENCE TABLES	238
Matrix Controller Experience Progression	181	THE CHARACTER SHEET	239
Empath Powers	182	<b>LIST OF TABLES AND CHARTS</b>	
Energy Controller Powers	189	THE GALACTIC TIME TABLE	13
Healer Powers	195	<b>VITAL STATISTIC TABLES</b>	
<b>BATTLE MASTER SECTION</b>			
Types of Battle Masters	205	Strength	17
Handling Player Characters	205	Strength Limitations Table	17
Running Your Own Campaign	205	Manual Dexterity	17
		I.Q.	18

Table of Contents

Agility ..... 18  
 Constitution ..... 18  
 Intuition ..... 18  
 Charisma ..... 18  
 Statistics Comparison Tables ..... 19

**RACES**

RACIAL PREFERENCES ..... 19

**CHARACTER GENERATION**

Height and Weight ..... 48  
 Size Class ..... 48  
 Body Points ..... 48  
 Movement ..... 48  
 Number of Attacks ..... 48  
 Damage per Attack ..... 49  
 Vision ..... 49  
 Smell ..... 49  
 Hearing ..... 49  
 Planet of Origin ..... 49  
 Social Status ..... 52  
 Starting Money ..... 52  
 The Survival Matrix Roll ..... 55  
 I Was Just Growing Up Tables ..... 55

**OCCUPATIONAL SKILLS**

OCCUPATIONAL SKILLS TABLE ..... 61

**ARMOR, WEAPONS AND EQUIPMENT**

EFFECT OF WEAPONS HITS ..... 75  
 ARMOR TABLES ..... 76  
 HAND WEAPONS ..... 86  
     Ammunition ..... 87  
     PMS Payload and Guidance Systems ..... 89  
     Mag Gun Munitions ..... 89  
 MISCELLANEOUS EQUIPMENT ..... 92

**BIONICS**

The Effects on Constitution ..... 128  
 Construction Cost ..... 128  
 Construction Budget ..... 128  
 Allocation of Space ..... 128

**VEHICLES AND ROBOTS**

Critical Hits ..... 136  
 Defense Systems ..... 143  
 Heavy Weapons ..... 143

**LIVING IN THE FUTURE**

Cost of Living Chart ..... 155  
 Smuggling Table ..... 166

**SPECIAL POWERS**

Chatilian Special Powers ..... 180  
 Mutzachan Special Powers ..... 180  
 Zen Rigeln Special Powers ..... 180  
 Matrix Controller Advancement Tables ..... 181

**BATTLE MASTERS SECTION**

Critical Hits ..... 209  
 Wound Recovery ..... 210  
 Non Player Character's ..... 210  
 Random Encounter ..... 211  
 Monster Generation ..... 217  
 Structural Strength ..... 217  
 Valuables Commodities Table ..... 218  
 Trade Items ..... 218  
 Light Sources ..... 219  
 Power Units ..... 221  
 Regional Offices ..... 221  
 The Boss ..... 221  
 Rapid Decompression ..... 222  
 Malfunctions ..... 222  
 Prestige ..... 223  
 Rank ..... 224  
 Black Marks ..... 225  
 Starting Contacts ..... 228  
 Distribution of Networks Contacts ..... 229  
 Frontier Networks ..... 229  
 Availability of Items ..... 232

GENERAL COMBAT REFERENCE ..... 237  
 THE QUICK COMBAT REFERENCE ..... 238  
 THE CHARACTER SHEET ..... 239

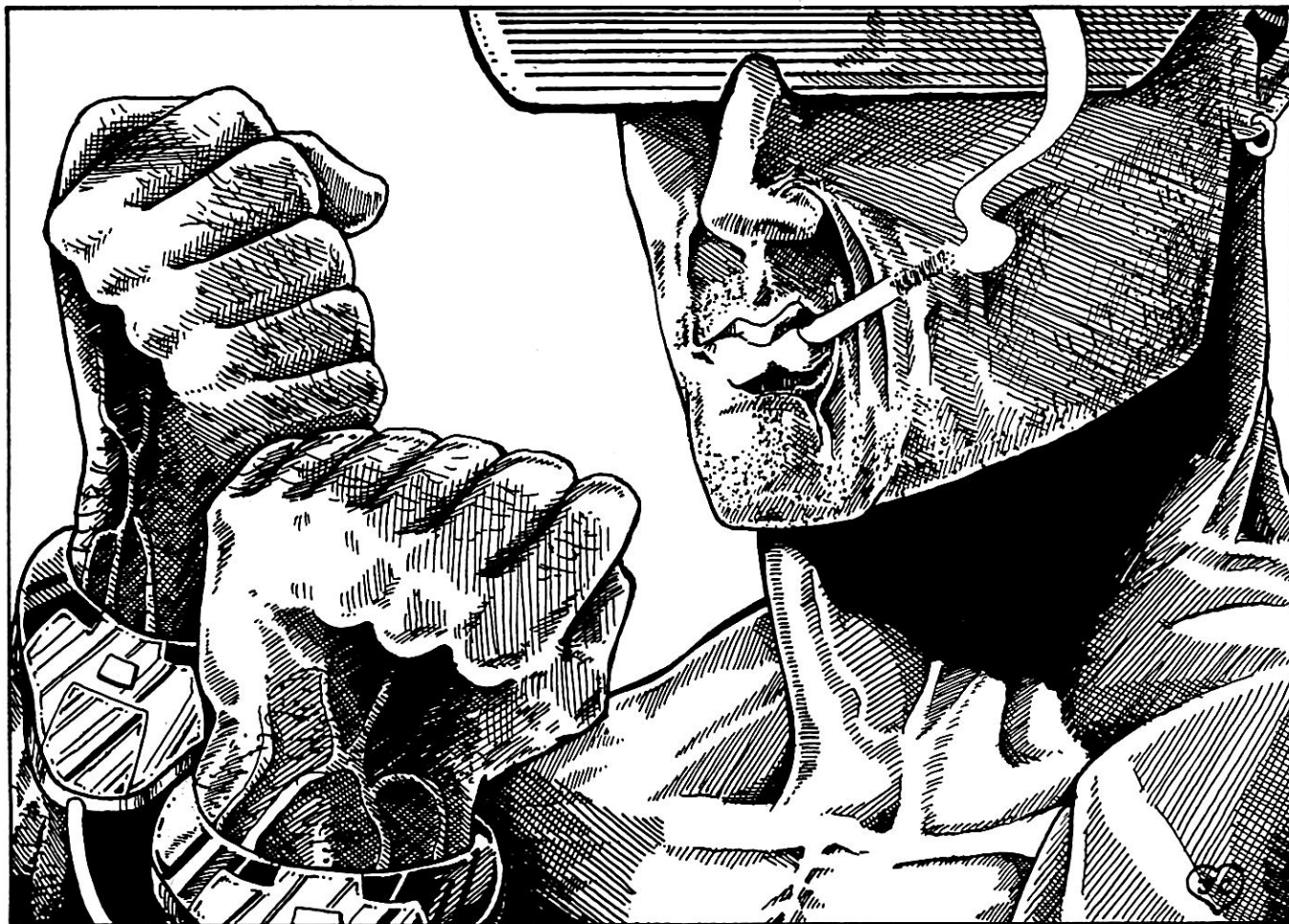

## INTRODUCTION

Let's get right down to business. *Battlelords of the 23rd Century* is a futuristic roleplaying game designed to simulate the life of explorers and combatants in the not too distant future. Your playground is the Milky Way, the Andromeda Galaxy, and more. The system was designed to provide a gaming environment which is a mixture of Roleplaying and combat action. That's it!!! **It's designed for roleplaying and Hack and Slash.** For those of you who prefer the exquisite taste of extensive combat situations, I made sure that your wishes can be made to come true. But it is my belief that players will enjoy the system more if they concentrate on the roleplaying aspect instead of the combat aspect. Again, that is up to you. For those people who have never played a roleplaying game, don't worry. It's not the end of the world. Every time that you have been around gamers, you've been totally lost. They talk about mysterious things like d6's and babble on about spells that they've learned. This guidebook takes you step by step through the playing process. Read it through carefully and you'll be in excellent shape. You may wish to consult experienced gamers for advice about combat strategies, but all in all, you'll be their equal. When it's over, you'll be fighting the Rebels off the Sea of Orion, chasing a pirate ship through the dangerous Magellanic Clouds, or tracking the vicious Arachnids.

For those hardened veteran Gamers, I designed this system especially for you. We need a futuristic roleplaying game that's not shallow and two-dimensional. *Battlelords of the 23rd Century* provides the player with a complete, competent, up to the present history of events, a thorough understanding of viewpoints, and the subtle nuances of futuristic life. *Battlelords of the 23rd Century* has 12 fully developed character races (with sub-species). The combat system works efficiently, moving quickly, without the need for a "skillion" different tables. Combat produces hit locations for the body, making gaming more realistic yet not tedious. Furthermore, there are over 200 different weapons that player characters can choose from when shopping for equipment. Most of all: Developing the character is easy!!!

The *Battlelords of the 23rd Century* guidebook is a compendium of knowledge, designed to facilitate the play of *Battlelords of the 23rd Century*. **This is the ONLY book you need to buy to play the game.** You don't have to spend tons of money, purchasing three or four books just to get started. Let the Battle Master spend the money. He wants all the books anyway. It is my opinion that you should spend a little extra time generating the character that best suits your needs and worry about weapons afterwards. Money allows the character to do just about anything, from purchasing state of the art equipment to gaining new proficiencies through training classes. I've added a section on trade so that players can buy and sell a variety of goods to secure funds for the up and coming adventure.

*Battlelords of the 23rd Century* is percentile based and uses a modified skill system. Over 150 years of combined gaming experience, some 7000 hours of computer time, 200 or so headaches, 80 backaches, 12 near nervous breakdowns and a lifetime of problem solving has gone into the production of the game. This extensive knowledge of gaming has helped to facilitate the creation of the system. I've been gaming for ten years, and Game Mastering for nine of those. My cohorts in crime and I have mapped out a fully functional universe in the not too distant future. It wasn't easy, but nothing good ever is. The idea came into being at the dinner table, over some Buffalo style chicken wings. Once one of my friends asked me whether I could create a futuristic roleplaying game. He claimed that there wasn't one available. I said that I would try, and this is the result.

The problem was to develop a comprehensive, futuristic world with all the trimmings. It was first necessary to set up a platform for thinking. We all have some idea of what an Elf looks like and a fair idea of how he acts. However, no one knows what a Phentari is or what that evil being might be contemplating. So I started by developing the general personality traits of the player races, then we added a lot of art work so you would have a good visual frame of reference. Finally, we built the world and added in the mechanics.

### THINGS TO CONSIDER:

1. Don't pick the most powerful race, utilizing the most powerful weapons available. Pick the race that you will enjoy playing the most and choose the weapons most suited to that race.
2. Don't become obsessed with experience points. They will come and you will progress in skill proficiency.
3. Refrain from protracted arguments with the Battle Master. It slows down play considerably and it tends to get you KILLED.

Without further ado, let's get on with it. **GOOD LUCK BATTLELORDS AND REMEMBER TO KEEP YOUR HEADS DOWN!!!!**





101 000 9A 000

BLACK WIDOW

MEDITAB

53

001

## QUICK START

Battlelords of the 23rd Century is a long book. It is understandable that beginning players would hesitate to read through the entire thing before starting play. This isn't necessary. If you are a player and you wish to begin playing the game in short order, then follow these guidelines. Now understand that you will miss out on a lot of important information. It will be necessary for you to read through the book later on. Battle Masters should read through the book and get a good understanding of the material before attempting to run a game. It isn't paramount that you read through the item descriptions. However, you must be familiar with the overall setup. For a quick start, follow the procedure below:

1. Read the race descriptions and decide which race you wish to play. This is backward, but works better if you are using the Quick Start method.
2. Read the Vital Statistics chapter carefully. You must understand this section of the book completely before proceeding. Remember that your vital statistics play a major roll in how your character has to be played. IQ and Intuition are the most important vital statistics in the game.
3. You must read the following from chapter 3, Character Generation:
  - Body Points
  - Social Status
  - Primary Occupations
  - Experience Points

NOTE!! Body points dictate how much damage your character can take before he falls unconscious.

NOTE!!! Experience points allow you to gain new skills. Every 1000 experience points earns you an extra skill point to choose more skills. If your character is a matrix controller, then his experience points are split up, half going to his matrix studies, the other half goes to the learning of new skills.

4. Occupational Skills: Skim the part up to the Occupational Skills table, but make sure that you thoroughly understand:
  - Starting Proficiencies
  - Primary Occupations
  - Proficiency Cost

Consult the Occupational Skills Table. SC stands for the point cost to obtain each level of a particular skill. If a skill costs 5 points (like Acrobatics), then you could purchase 3 levels for 15 points. You group 25 points worth of skills under one general field. The field chosen is your primary occupation. Once you have chosen a primary occupation, spend the other points freely.

NOTE!!! Spread around your non-primary skills. Failure to do this will limit your character's ability to deal with the unexpected.

5. Armor: Read the following:
  - Threshold
  - Absorption
  - Armor Integrity

NOTE!!! Threshold blocks damage. Unless the damage dice rolled are higher than the threshold of the armor, no damage is done (exception: Omega Weapons and concussion effects). Whenever the damage dice exceed the threshold level, the attack is assumed to have penetrated the armor. The amount of armor integrity that is destroyed depends on the type of attack. The amount of damage that penetrates (dice roll - threshold) equals the amount of damage that is subtracted from the absorption rating. The absorption rating is effectively the armor's body points. When the armor runs out of "body points", yours will do just fine!!!!

6. Weapons: After you have read the weapons section, purchase some armor.
  - Introduction
  - Weapons Table Information
  - Emergency Medical Equipment (BRI)

NOTE!! Each weapon has a percentage chance to hit a target at a given range bracket. Add in 04% per level of skill that you have in that particular weapon type. The Battle Master will add in penalty modifiers for cover and concealment.

7. Combat. Pay close attention to:
  - Weapons Fire
  - Hand to Hand Combat
  - Matrix Combat
  - Combat and the Survival Matrix Roll
  - Mortality

8. Living in the Future need not be read, but it does provide for you a frame of reference by which to play the game.

9. Special Powers:
  - Energy Brackets
  - Power Points
  - Experience vs Generation
  - Gaining New Powers

## PICTORIAL REPRESENTATION

Futuristic roleplaying games are of a completely different genre as opposed to fantasy roleplaying games. Fantasy roleplaying games are generally based on mythology. Players typically have a preconceived notion of what the character they wish to play looks like, thinks, and how he or she behaves. Most of us have a pretty good idea of what an Elf looks like in our minds. However, no one knows what a Phentari is. Thus, a science fiction character race has to be created from the ground up. All viewpoints, ideologies, behavioral patterns, etc., have to be furnished for the gamer. The information must be complete and thorough, so that the player can accurately inhabit the mind set of the being he wishes to play.

Furthermore, none of us knows what a Phentari looks like. Thus, it is paramount that any new science fiction roleplaying game have many pictures in it, so that you, the player, can develop a concept of your character's physical appearance. Furthermore, you must be able to imagine what life would be like in the 23rd Century. Pictures are required for that as well.

Hence, I have found it necessary to amass a large number of full page drawings in the book so that you can better roleplay BattleLords of the 23rd Century. In conjunction with the art work, I have provided you with a description of each of the full page drawings in this book. Each description is numbered and the number cross references to the page that the drawing is on.

### COVER PAINTING:

On May 35th, 2170, Space Systems Development Corporation's 4th ARSAP (Advanced Survey, Reconnaissance, and Patrol) set down on Thor's Garden, an unexplored world annexed by the company for future development. The unit shortly thereafter uncovered an Arachnid advance base. Company SOP (Standard Operational Procedure) detailed that any unit encountering an Arachnid presence was to notify Alliance authorities then evacuate the area immediately until the military could be brought in to deal with the problem. Instead, Major Craig Merrill, the officer in charge ordered his men to engage the enemy.

"Men", he said. "I ask you to join me in battle. Millions have died at the hand of our enemy who lies unwary just over the bluff. We could abandon our responsibility and retreat.... as is company policy. Or we could meet the bastard, engage him, and smoke him like a cheap cigar!"

So it was that Merrill's Marauders attacked the Arachnids at the Battle of Majestic Mountain. Shortly after the attack, Merrill fell, slain in hand to hand combat. Here we see his second in command, Buddon Master Edmar-ican, leading the charge against the spiders.

In the end the unit was forced to abandon the planet, having suffered over 75% casualties. The courage and valor displayed by Merrill's Marauders exemplifies the true spirit of warriors and is legend among mercenary circles everywhere.

### THE BLACK WIDOW pg: 8

Now if you haven't already heard of the Black Widow, you had best be warned. She is making quite a name for herself on the mercenary circuits, taking out showoffs, incompetents, and other Mercs who get in her way. She owns a Class 3 bounty hunters license and loves to use it. Furthermore, tabloids rumor that she is actually Madd Mike Kantrell's main squeeze.

Her name is Karen Shesnowicz and the Black Widow packs some of the most deadly fire power imaginable. She sports an experimental gatling laser called the Cheese Cutter which fires 12 impact laser beams per second (doing 4-24 points of damage each). This weapon tends to leave a lot of holes in enemy personnel, hence the name. What stylish combat woman of tomorrow wouldn't carry 10 NARC reflex missiles with a voice activated firing sequence (85% accurate out to 800 meters, doing 20-80 points of damage)! The artist portrayal of the Black Widow shows her wearing mechanized battle armor. Her "brainbucket" is a Defender helmet and she is depicted here entering a suspected Rebel stronghold. She used a "small" quantity of jellnite to open an entrance. The end to this encounter was 64 dead, and 0 prisoners taken!

### GENERATION pg: 21

This picture depicts a Chatilian empath "generating". Energy isn't actually visible when Chatilians invoke matrices. But the picture looks cool!

### PROWLING pg: 23

A Cizerack from the Crasnare Clan is seen out patrolling a bluff overlooking her lands. The supreme leaping ability of Cizeracks allows them to move well in the mountains which are so common to the cat's home planet Cashoulis.

### THE TRANSGRESSION pg: 26

Here we see a poor fool who is about to get slaughtered! The intruder has trespassed on the holy ground of the Sun Temple. The sword master Ki-Lo-Ne has challenged the intruder to a duel in order to preserve the sanctity of the temple. Worn out by the overpowering might of a full Buddon Priest, the intruder lowers his head in final submission.

### HOT! pg: 28

This pictorial brings to light just how attractive Gen-Humans are. Different super gene types are mixed together to produce Gen-Humans. Gen-Humans don't look any more alike than normal Humans do, they just are far better looking. Gen-Humans justify the nebulous concept of a "10".

### HANGIN' OUT pg: 30

Just one version of a Human type.

### THE CHANGELING pg: 33

This abstract portrayal is designed to show a Mazian changing shape into human form. The picture merely illustrates this amorphous being's strange talent.

### ENERGY CONTROLLER pg: 35

A Mutzachan always folds his arms while generating. The angered expression reflects the deep state of concentration reached while an energy controller manipulates the formulas of energy incorporated in the matrix.

A powerful Mutzachan is given special robes (Szmalka) when he attains mastery of 4th energy bracket powers. This garb is stiff and juts forward and downward away from the controller's feet.

### MR. COOL pg: 37

Here we see an Orion Rogue in a popular skinsuit. Orions are fond of wearing sun glasses and a decent pair of "shades" is a definite must. They allow a Rogue to scan the area for potential victims, err... I mean business contacts, without anyone being able to see his eyes.

### JAQUASSARIOUS PHENTARI pg: 40

This picture is an artist's rendition of the legendary/infamous Jaquassarious Phentari, the most wanted criminal in the galaxies. Jaquassarious is wearing a bone lace cape called Wingala-Nairasu. This vestment has a 3 point threshold and protects the squid from attack.

Note the sloping, ridge lined forehead. This carapace grows deeper and more defined with time and the age. The bird-like mandibles allow the squid to tear the meat from its prey. Lastly, Phentari are nocturnal and prefer to emerge from their dwellings to hunt at night.

**SURPRISE ATTACK pg: 42**

This picture demonstrates the preferred method of attack by Python Lizards. Python Lizards sneak up on their prey under water, then jump up and blast 'em into pieces (gaining a -4 to initiative rolls).

**SUPREME KILLER pg: 44**

Rams can be found hunting Python Lizards in the great jungle marshes of Pythos. This particular Ram has just attacked a Python Lizard from above, sweeping down from the trees to tear his victim to shreds. The ferocity of Ram Pythons have earned them universal respect.

**MEDIC pg: 46**

A female warrior has fallen on the field of battle. A medic technician has rushed to her aid. Healers are able to stop the effects of otherwise mortal wounds. This Zen Rigeln invokes the matrix "Palm of Assizza" to heal the victim by absorbing the damage into himself. To quote the Grand Assizza, "Wounds are not mortal, only power is." When a Healer generates, a deep humming sound emanates from within his body.

**MULCH PILE pg: 50**

An artist's vision of Colonel Madd Mike Kantrell's legendary stand at what has come to be known as the Mulch Pile. Kantrell and his men were conducting patrols on Moraxal 4, a secure planet, when they were ambushed by Rebel forces. Some 50 of Madd Mike's men fell in the first minute of combat as they were struck down by a sheet of super heated plasma fired from the hands of Rebels lying in wait with pulse cannons. Those who survived the initial barrage hid behind the bodies of the dead and engaged the enemy in one of the fiercest battles of the Second Rebel Uprising. In the end, Kantrell singlehandedly held off the final attack, killing 24. He was wounded severely, losing both legs in the battle. For his heroism, Madd Mike Kantrell was awarded the Legion of Honor.

**FEMALE FEROCITY pg: 63**

A Cizerack lashes out with her razor sharp claws. The arm bands (Nneel-icry) signify which clan a cat belongs to.

**AQUATIC WARRIOR pg: 67**

A Python Lizard wielding his mighty Toma. There are 111 different species of Python Lizards. They do not all look the same.

**RAM BO pg: 74**

A Ram Python just being a Ram Python kind of guy. He is holding a Vector pulse cannon and wears BSH body armor. He is posing of course! Everyone knows that all Ram Pythons are "Hams."

**A BAD DAY AT THE OFFICE pg: 78**

This picture accurately illustrates the necessity of battle armor in keeping soldiers alive on today's hyper-violent battlefields. This Human is wearing Bear battle armor, a no-frills defense suit that is quite effective in most combat situations. The impact pattern on his chest is from bullets, while the huge tears across his shoulder and thigh are clearly the result of plasma hits.

**THE FIRING LINE pg: 95**

Mercenaries discharging their weapons on the firing line. The count is given as such: "Firers lock and load one magazine. Keep your weapon on safe. Repeat. Keep your weapon on safe." Safety officer: "Clear the firing line. Left, right, middle is clear. The firing line is clear. Firers take you weapon off of safe... AND ROCK-N-ROLL!"

**THE WARRIOR pg: 109**

This warrior is out for another day at the office, toting a Cobra-XM2 Omega cannon. He is wearing Mesh battle armor and a Goliath defense helmet. He just finished his pillaging and plundering workout for the day and is heading home to the family!

**BORG pg: 129**

Cyborgs aren't generally handsome looking beings. Plastic surgery is almost as expensive as the hardware. Thus, most Borgs look like machines. Presently, the prominent Cyberdome Research Company is modifying body structures to allow for the implant of armor options. It is figured that the cost will be 10 times the list price for the option.

**ROLLING pg: 135**

Mercenaries require a variety of transportation to get to and from the battlefield. One of the more popular combat vehicles is the vaunted Von Horses main battle tank.

**BREAKING THROUGH THE CLOUDS pg: 137**

This is a picture of a Bohemian class star cruiser breaking through the clouds on a pirate mission. This vessel has a gravitational landing system and is the ultimate hit and run vehicle. An Orion is probably at the controls of this sleek piece of machinery, even if it wasn't originally his.

**SPARTAN pg: 141**

If you want to destroy a planet, you drop in a half a dozen of these monsters to do the job. The Spartan sector control robot carries 16 Bonoir anti-tank missiles and twin Valley Green laser cannons (1,000 shots each). The Spartan was designed to combat Rebel ground forces. It is a self surviving unit with on board repair functions. There is absolutely no reason for a robot to carry personnel, unless they serve as passengers. The artificial intelligence modules of the 23rd Century are more than adequate to perform decision making functions.

**CLOSE UP pg: 146**

A close up of a Phentari wearing his atmospheric processor. These devices convert water plus CO<sub>2</sub> into methane through a complicated oxidation/reduction reaction. Models are currently being designed to convert methane into oxygen.

**ARACHNID pg: 149**

The artist is trying to point out the raw hatred that the Arachnids display toward Humans by depicting a spider eating a Human skull. Fact: Arachnids aren't pure arachnids. They possess qualities of mammals as well and come under the biological classification of Prigalas Mammalia (spider-mammal). Arachnids are meat eaters.

**SKYLINE pg: 152**

An artist depiction of a typical Tech level 5 city. The majority of Alliance cities are of this genre. Also, most Tech level 4 and higher cities possess sophisticated spaceports.

**THE WALL pg: 158-161**

This is a picture of an average wall in a Tech 5 city. Nothing has changed. People still insist on scribbling their views on things that don't belong to them. It still looks neat too!

### **CARRIER DUTY pg: 164**

The Human carrier Yorktown holds its position within the fleet as the task force heads for battle "Over the Sea of Orion" during the 1st Arachnid IncurSION. A heavy carrier such as the Yorktown can field over a hundred combat shuttles and support vehicles. Typically, a modern heavy carrier has 6 squadrons of fighters, 2 squadrons of combat sleds (heavy bombers), and a variety of support shuttles such as tankers and reconnaissance vehicles.

It was the Yorktown that saved the expeditionary fleet from utter destruction at The Battle Over the Sea of Orion. Her fighters are credited with the destruction of 5 Arachnid ships. At the time of the invasion, Arachnid warships were vulnerable to fighter attack, as spider point defense technology was limited. From her decks was launched the heralded Flight of the Valkyries!

### **BLACK ERIDANI pg: 167**

The nefarious Black Eridani is the bane of the Eridani people. Black Eridani are a result of Phentari genetic engineering. These malevolent beings have no pain sensors in their bodies and are radically more violent than their brethren. This genetic perversion is bent on the utter destruction of all living things, save the Phentari and Orions. Of course, Black Eridani are indistinguishable from normal Swordsaints. They are, however, mentally unstable, and often suffer from a mental disorder called Reclusive Endritis (Super Psychosis).

*If the destruction of the Eridani race can be played out by their own hands, then Phentari will further rejoice at their inevitable destruction. The Black Eridani is merely an extension of the perverse code of logic employed by these hypocrites who have the audacity to call themselves honorable. Phentari are masters of what you Humans call payback. The Black Eridani is our Trojan Horse given "as gift" for the egregious acts committed against my people. No foe has ever vanquished us, for we are supreme. Let Swordsaint slay Swordsaint while we Phentari watch from the galleries of history and applaud their doom. Forever Phentari. Empire of the Universe!*

*Jaquassarious Phentari*

### **MRS. MUTZACHAN pg: 183**

This is a picture of a female energy controller. Oh by the way, guys like Henry the Mutzachan think this babe is hot!!!!

Female Mutzachans are known to harness more power than males (+1 power point) 30% of the time.

### **GEMINI pg: 196**

This is a picture of a newly re-discovered race of matrix controllers called Gemini (future character race). Gemini are known to possess powers over the forces of nature. They are made of what is commonly called flesh stone, a silicon composite tissue which protects the Space Druid from danger (3 point body threshold). The Gemini are currently awaiting entrance into the Council of Timar.

### **F-16s TO THE ATTACK pg: 204**

F-16s are the front line fighter of the Alliance defense forces. This combat shuttle can be ground or space launched and has an effective combat range of 10 parsecs. It carries a variety of munitions and is equally suited for intercept and bomber roles. Here, three Tomcats are seen accelerating to attack speed.

### **THE PRIDE OF ERIDINE pg: 206**

The pride of Eridine, the Akeel-a class battlecruisers are the backbone of the Alliance fleet. Here, the Acromi is making for battle station Rascal on impulse power. Note, she mounts 9 point defense laser turrets, three on her Pi-deck (top deck), three on her Am deck (under

deck) and one to port, starboard, and stern. Just aft of the bridge are missile ports. The true might of the Akeel-a class battlecruisers are their photon heavy cannons which are mounted to the forward section of the engine boom at the stern of the ship. Only a handful of the mighty vessels were built with flight decks to service a squadron of fighters.

### **ON THE PROWL pg: 213**

Three Phentari heavy cruisers prowl the void of space, hunting down fleeing Rebel forces at the Massacre on Tulbadar. Phentari ships mount ultra-heavy alternating phase laser systems, usually two in the front and one on each wing.

### **TAKING COVER pg: 220**

This Human got into a fire fight and is taking cover behind the wall. He confidently holds a Savage-B laser pistol in his hands, cheap cigar in mouth. No need to worry because Savage-Bs don't miss much inside of 100m, let alone 10m. This Human is simply waiting for an opportunity to put some holes in an unseen enemy. The Savage-B is the best auto-fire laser pistol currently available on the market.

### **TEMPLE BUDDON pg: 226**

An Eridani warrior kneels before the High Priest in the Great Hall of Truth in Temple Buddon. The customary recognition of valor is for the Buddon Priest to thrust his fist toward the sky and shout, "Aki-la-nigeman. Doft tzeel a-tel-a-me jantor. Kor-mie! Kor-mie!". Translation: "Kneel before your Lord. Speak to me of your triumphs. Of victories! Of victories!".

### **WASTED pg: 231**

This foolish person made the error of bringing a sword to a gun fight. He got wasted by the less than honorable Phentari who stands just outside the picture. This picture also points out the reasons why people shouldn't purchase "cheesy" battle armor. Oh, by the way, pulse cannons are considered to be guns, and this is what a M-80 will do to you if you aren't adequately protected. Our friendly Phentari has brought along his fax machine so he can send the victim's mother a condolence card!

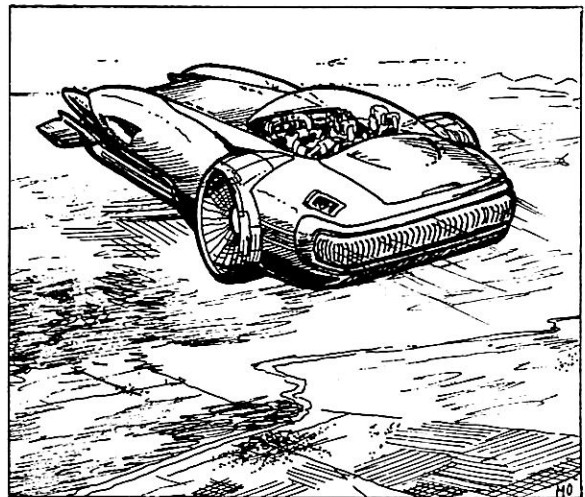

## The Galactic Time Table

- 50000 B.C. Man first walks the Earth.
- 35777 B.C. The first Python Lizard crawls up from the Black Sea.
- 21550 B.C. The Mutzachans first experiment with the concept of Mutzia-cieve' on the planet Trishmag in the Cygni-A star system.
- 18760 B.C. The Mutzachans develop inter-galactic space travel.
- 16422 B.C. The Veayan Plague wipes out 75% of the Mutzachan population.
- 12224 B.C. The birth of Makov, the first Chatilian Highlord.
- 12097 B.C. Death of Makov and the beginning of the Totalitarian Inquisition. The use of special powers is condemned on the planet Chatil. The 'Illuminaries' are hunted down and executed.
- 11367 B.C. The Mutzachans make an exodus from their dying planet and settle on the 4th planet of what is known as the Epsilon Indi system. The relocation takes 300 years.
- 10784 B.C. Mutzachans discover a race of matrix controllers called Gemini in the Sculptor Galaxy.
- 10671 B.C. The great civilization of Atlantis rises.
- 9874 B.C. Mutzachans colonize the Sigma Draconis system.
- 9110 B.C. The Mutzachans visit the planet Earth of the Sol system.
- 8911 B.C. The Chatilian Civil War begins and will last for 57 years.
- 8907 B.C. The Atlantians develop interstellar space travel.
- 8555 B.C. The Mutzachans colonize the LFT-1747 system.
- 7906 B.C. The Atlantians develop inter-galactic space travel.
- 7583 B.C. The Flagship Atlantis and its contingent of expedition ships set out on a 200 year mission to the Magellanic Clouds and is never heard from again.
- 6504 B.C. The Eridani develop inter-planetary space travel.
- 6108 B.C. Re-birth of the Sida-shiem and the 'Illuminaries' rise to power again. The School of the Mind is built on Chatil to provide training for those with "The Power".
- 6001 B.C. The Eridani develop interstellar space travel.
- 5477 B.C. Massacre at Benjari. Eridani attempt to populate the planet Dia of the Kied A star system and are unexpectedly attacked by an alien race of Arachnids. Only the light cruiser Magas and the transport Mengias return.
- 5355 B.C. The Eridani develop inter-galactic space travel.
- 5301 B.C. The Mutzachan exploration ship Guasgh disappears over Beta-Hydri.
- 5288 B.C. The beginning of the Shida/Ocason War amongst Chatilians. It will last for 87 years, followed by peace for another 1000 years.
- 4807 B.C. Eridani exploration vessels set sail for the Andromeda Galaxy.
- 4500 B.C. Queen Chea the 3rd begins systematic extermination of 'The Wretched' on the planet Vissu of the Wolf-922 star system.
- 4487 B.C. The Vissu escape through the net of warships surrounding their planet and flee out into the galaxy.
- 4309 B.C. Humans of Atlantis populate the Lelande star system.
- 4300 B.C. The colony at Tl-4 of the Lelande system is wiped out by a mysterious plague.
- 4288 B.C. The Eridani colonize the LFT-215 star system.
- 4227 B.C. The Phentari of the Tau Ceti star system develop inter-planetary space travel.
- 4012 B.C. The Phentari develop inter-stellar space travel.
- 4011 B.C. The Eridani colonize the CD-18 star system.
- 4009 B.C. Contact with the colonies in Andromeda is mysteriously broken off.
- 4003 B.C. The Vissu reach the star Betelgeuse and stumble upon the Orion peoples. They are welcomed.
- 3500 B.C. Tar of the planet Pythos, develops the deadly Blade of Sharras which will be used in the Pythos/Cameon War.
- 3477 B.C. Beginning of the Pythos/Cameon War. The Ram warlords defend against the tyranny.
- 3431 B.C. Phentari war vessels are destroyed by an Eridani expedition fleet.
- 3389 B.C. The Phentari retaliate and destroy the Eridani Flagship Mirini over Hemalan.
- 2945 B.C. The Phentari make first contact with the Orions in the Piscium system.
- 2608 B.C. Beginning of Manchu Dynasty.
- 2500 B.C. Rise of Greek Empire.
- 2403 B.C. Orions develop inter-stellar space travel with the aid of the Phentari.
- 2400 B.C. Orions colonize the Delta-Eridani system.
- 2356 B.C. Orions colonize the Ross 41 star system.
- 1770 B.C. The Phentari and Orions form the Kwashime Alliance. They marshal their forces at Tezeras and launch an all out attack on Eridine. Eridine is virtually reduced to rubble. The Justification War ends.
- 1600 B.C. Cizerack first develop interstellar space travel.
- 1500 B.C. The rise of the Egyptian Pharaohs.
- 1482 B.C. After 300 years of battle, the Accords of Hatil are signed and a tense peace begins between the Eridani, Phentari, and Orions.
- 1322 B.C. The Zen Rigeln enter the Age of Prosperity.
- 1066 B.C. The Second Python Civil War begins. It rages for 70 years before it ends at the battle of The King Slayers.
- 1011 B.C. The Cizerack colonize the Beta Comae star system and discover the Mazians. Friendly relations are established.
- 500 B.C. The Rise of the Roman Republic.
- 422 B.C. The End of The Age of Prosperity.
- 222 B.C. The Mazians and Cizerack sign the Geanteras Peace accords and establish open trade routes.
- 88 B.C. The Eridine and the Orion Republic sign the Taos Trade Agreement which establishes open trade routes between the two empires.
- 42 B.C. The Mutzachans declare a neutral zone within 20 light years of Cygni-A. Enforced by the Council of Timar. The declaration states that any violation will result in termination of the responsible race. The purpose of this was to allow local races to evolve at their own rate.

**The Birth of Christ.**

- 25 A.D. The Mutzachan expedition to Kapteyn's Star is destroyed by the Arachnids.
- 97 A.D. Cizerack develop inter-galactic space travel.
- 435 A.D. Fall of the Roman Empire.
- 1085 A.D. The Crusades begin.
- 1156 A.D. The Phentari colonize Piscium.
- 1275 A.D. The Great Assizza takes the throne and the Zen Rigeln enter the Second Age of Prosperity.
- 1492 A.D. Columbus discovers America.
- 1604 A.D. The Great Assizza dies.
- 1776 A.D. The American Revolution begins. It lasts for 7 years.
- 1850 A.D. The Great Plague all but destroys the Mutzachan people.
- 1856 A.D. The Cizerack make contact with the Pythons.
- 1857 A.D. The Cizerack emissary to the Python nation is murdered at Makel. The Cizerack invade the planet Pythos. Mutzachans abstain from intervention due to internal problems.
- 1914 A.D. Earth's first global war begins. It lasts for 4 years.
- 1929 A.D. The Great Depression.
- 1930 A.D. Eridani enslave a race of blue humanoids called Zendareans.
- 1941 A.D. The Pythons are forced to capitulate and the War Against the Lizards ends. The second world war begins on the planet Earth and 55 million people are slain. It ends with the dropping of the first atomic bomb on the unwary city of Hiroshima. Nuclear escalation begins.
- 1969 A.D. Men land on Earth's moon.
- 1970 A.D. The Mutzachan exploration freighter Uranium Sun suffers engine damage and is rescued by a strange being who suddenly materializes on the ship's bridge and fixes the problem with the sweep of a hand. He calls himself a Dane and then disappears.
- 1971 A.D. Pythons rise up against the Cizerack and the occupation ends.
- 1999 A.D. Limited nuclear war destroys 1/3 of Earth's population.
- 2012 A.D. Earth deploys the first multi-staged space platform from which future deep space missions will be launched.
- 2034 A.D. Humans establish a permanent colony on Mars.
- 2049 A.D. Dr. Rosenthal develops Flex Steel. Humans develop inter-stellar travel. Humans settle in the Ursa Majoris system.
- 2051 A.D. Humans settle the AD Leonis system. The Mutzachans contact Earth and friendly relations begin.
- 2075 A.D. The Clone Wars begin between the Humans and Genetic Humans. The war lasts 7 years. In the end, the Clone Laws are passed and peace is re-established on Earth and its colonies.
- 2078 A.D. Phentari discover a race of humanoids called Kizanti in the Fornax Galaxy. They are enslaved.
- 2086 A.D. The Earthlings discover the Zen Rigeln in the Rigel star system.
- 2091 A.D. With the aid of the Mutzachans, Humans and Gen-Humans build the first stargate. Earth builds a vast space fleet and its people sweep outward to conquer the universe.
- 2092 A.D. Skirmishes erupt between Washiran and Human forces in the Haniz star cluster of Andromeda.
- 2095 A.D. Trade is established with the Xarians from the Magellanic Clouds. They were later determined to hold strong ties to the Arachnids.
- 2108 A.D. The First Arachnid Invasion begins.
- 2109 A.D. The First Council is convened on the planet Earth. All the known races attend. A plan is worked out to stop the Arachnid invasion. The humans send out a fleet to ambush the Arachnids. The plan is successful. The invasion is stopped with the loss of 13 warships, including the Earthling battle cruisers Valiant and Windsor, the heavy cruiser Choi Ling, the escort cruiser Providence, and destroyer Brazil. The Galactic Alliance is formed, under the established control of the Gen-Humans.
- 2145 A.D. Phentari patrol cruiser sights an unidentifiable alien vessel. Hailing frequencies are broadcasted. The ship simply vanishes.
- 2187 A.D. The First Rebel uprising is crushed by the Alliance.
- 2189 A.D. Professor Alexandrotos discovers the Omega Principle. It will be used to produce weapons.
- 2193 A.D. Galactic Stormtroopers destroy the Rebel base on Kitchara of the Gamma Leprois star system.
- 2216 A.D. AMC discovers the largest vein of Tiritium in the galaxies on the planet Nwaga of the Smaller Magellanic Clouds.
- 2219 A.D. Second Arachnid Invasion begins.
- 2220 A.D. The Second Rebel uprising begins.
- 2224 A.D. An exploration fleet sent to explore the Carina Galaxy disappears without a trace.
- 2228 A.D. Eridi-Corp officials are brought up on charges of murdering some 5000 Phentari vacationers who landed on an Eridani planet. They are acquitted for lack of conclusive proof.
- 2230 A.D. Humans discover the Sheustrons in the And 3 galaxy.
- 2248 A.D. The massive push to settle the Andromeda Galaxy begins.
- 2252 A.D. Balshrom Science Corporation becomes the number one arms producer in the known universe.
- 2256 A.D. The Second Rebel uprising is put down at the Battle of Terasleague.
- 2258 A.D. A Dane materializes at the Council of Timar and speaks ominously of portending dangers. He claims that the Alliance shall be destroyed and then vanishes.
- 2259 A.D. The Alliance forces do battle with an alien race called Krakeds in the Andromeda Galaxy. After fierce fighting, a truce is signed.
- 2265 A.D. SSDC builds Stargate Horizon in the Ursa Major super cluster, some 200,000,000 light years from the Core Worlds.
- 2267 A.D. Professor Uncle Ernie Freiberg escapes from jail and releases the Blood Warlock which kills 2.5 million people. He then starts the Anarchist Rebellion Movement (ARM), designed to annihilate the Alliance by producing and dispersing dangerous life forms throughout the galaxies.
- 2268 A.D. A Dane appears on the Floor of the Council of Timar for the second time. He claims "Atlantis understood the threat and took measures to safeguard its own survival. Have you taken measures to ensure your own. Do not hastily assume your enemies". He vanishes.
- 2272 A.D. The battlecruiser New Washington and her contingent of warships ambush and destroy an Arachnid Mothership over Tau Ceti. Jaquassarious Phentari destroys the planet Sharron and becomes the number one wanted criminal in the galaxies.
- 2273 A.D. Arachnids obliterate the planets Salvador and Zwim Mon Damnax of the Andromeda galaxy. Reports claim that a third invasion may possibly be under way. The 7th fleet, lead by the carrier Enterprise is dispatched to the area.
- 2275 A.D. The exploration ship Peristroika disappears in the Crab Nebula.

## FOR THE BOLD, STRONG, AND CURIOUS

It is the 23rd Century. The exploration and development of the known universe is going on at a fantastic rate. The Galactic Alliance has prophesied the complete control of the Universe by the turn of the millennium. Huge, powerful mega-corporations run it all from behind the scenes. The Twelve Races of the Forge work as caretakers, shaping and expanding the horizon of knowledge, extending to touch the farthest reaches of space. Frontier Colonies populate neighboring galaxies: Andromeda, Fornax, Spirax (M31), and the Magellanic Clouds. Outposts dot M32 and the cluster galaxy of Talcos, some 200,000,000 light years from Terra. The continuing battle rages onward to drive out the Arachnid presence. Strange reports of ghost ship sightings, robot warriors, and evidence of ancient human cultures all filter their way across the vast, empty stretches of nothingness to the hearts of the bold, strong, and curious.

*Our destiny is out there beyond the furthest star. Humanity must leave the planet Earth. We have used up and abused our mother's milk. She has no more to feed us. We have poisoned her bosom with our greed and shortsightedness. So we must head outward into the unknown. It is there that our destiny shall be forged.*

From the diary of a Buffalo college student  
1/20/1990

### STARTING EQUIPMENT

All you need to play Battlegrounds of the 23rd Century is scrap paper, a character sheet, some dice and a lot of imagination. My job was to prepare all the necessary material so that you can do this easily. In the back of the book is a sample character sheet. To create an abundance of character sheets, simply go to a copy center and run off some extras. The scrap paper is for listing possible vital statistics, but that will be covered later. You also need to buy some dice. I can't tell you exactly where to go, because I don't have the foggiest idea where you live!!! A safe bet is to go to your local "gaming" shop. Now if you live in East Guatemala and the closest place is the local cattle feed store, then I have no idea what to tell you. Maybe you could write me and I'll mail you some dice. You need these dice: 2 four sided, 2 six, 2 eight, 2 ten, 2 twelve, and 2 twenty sided dice.

### THE CHARACTER SHEET

An example of a character sheet is given in the back of the book. When you are creating your character enter the information onto a copy of the character sheet.

### IMPORTANT TERMS

**Arachnids:** The alien race of spider-like creatures presently at war with the Galactic Alliance.

**Battle Master:** The overseer of the game. The Battle Master sets up and adjudicates situations that occur during the play of the game.

**Campaign:** This word is used to describe a series of ongoing adventures.

**Galactic Alliance:** The body governing the "secured" quadrants of the universe. It is primarily run by Genetic Humans.

**Galactic Corporations:** Huge powerful companies that run the government from behind the scenes.

**Generation:** The process of harnessing and releasing psycho-kinetic energy.

**Heavy Points (HP):** 1 Heavy point equals 100 normal damage points.

**Kinetic Based Attacks:** Those attacks which utilize objects which impact with other objects to cause damage.

**Matrix:** The specific formula/process used to channel psycho-kinetic energy from its potential to active state.

**Matrix Controllers (MC):** Those individuals who possess the ability to harness and transmit psycho-kinetic energy.

**Parsec:** 3.27 light years.

**Percentile Dice:** Take two ten sided dice. State which is the tens dice and which is the ones. The tens are called "high". The ones are called low. The high die is read first. **Example:** Red is called high and green is called low. A red six and a green three are rolled. The result is a 63.

**Roleplaying:** Creating a fictitious character and playing him during the course of a campaign.

**Scenario:** This is the specific adventure that the players are involved in at any given moment. Normally, the Battle Master has set up a plot that is to be followed. This is called the scenario.

**Standard Day:** A 30 hour period of time.

**Standard Week:** 7 standard days.

**Standard Month:** 5 standard weeks.

**Standard Year:** 350 standard days, or ten standard months.

**Survival Matrix Roll (SMR):** The Survival Matrix represents the chance an individual has to resist the effects of a dangerous, non standard attack form. The SMR is made in the event of such an occurrence.

**Vital Statistics:** Numbers that denote the physical and mental prowess of an individual. 50 is considered average.

## VITAL STATISTIC GENERATION

Battlegrounds of the 23rd Century is a futuristic roleplaying game, designed to simulate life in space during the not too distant future. Battle Masters should allow players to generate viable characters of their chosen race and profession. Due to the randomness of dice rolls, character generation often produces marginal results. Since the character's vital statistics tend to correlate with his life expectancy, character generation is deemed to be of extreme importance. Battle Masters may opt to allow a player to reroll his character, if he has less than two unadjusted rolls above 70 or more than four unadjusted rolls below 30. Secondary statistics are based on vital statistics.

The following methods have been devised for the generation of vital statistics. All of the vital statistics tables have been grouped together at the end of this section for quick referencing.

### METHOD 1

Percentile dice are rolled and marked down in order of the given vital statistics. Eight rolls are initially made. The player then makes three additional dice rolls. He has the option of replacing any three previously rolled statistics with one of these numbers. **PLAYERS MAY NOT MOVE ROLLS AROUND!!!**

### METHOD 2

Percentile dice are rolled and jotted down on a separate piece of paper. Ten rolls are made. The player then discards the two lowest rolls and places the remaining eight numbers in whichever vital statistic slot that he chooses. After this is done, the player then adds in the race modifiers. This is the most popular method of generating a character.



**METHOD 3**

Percentile dice are rolled eight times and written down in the order that each vital statistic occurs on the player character sheet. This generates the first set of possible numbers. Five more sets of numbers are then rolled. The player chooses which set of dice rolls that he or she likes the most and writes them down in the order of their appearance. Dice rolls may not be moved around.

**VITAL STATISTICS****STRENGTH**

Strength is a measure of a character's physical prowess. It represents what he can military press, dead lift, and squat. A military press entails lifting an object to one's chest and then pressing it above his head. The dead lift is bending at the knees and lifting an object straight off the ground. An example of a dead lift would be attempting to lift the front of a car. Squatting measures the amount of weight that an person can rest on his shoulders, before squatting at the knees and then standing erect again. A character with a strength of 01-10 is only capable of lifting 20lbs (12.4 kg) above his head, and dead lifting 60lbs (37.2 kg). On the other hand, an individual with 150 strength, (the maximum available by natural means), could military press 500lbs (320kg), dead lift 1500lbs (960kg), and squat 1000lbs (620kg). The maximum encumbrance weight that a character may carry is relative to his strength. Strength also has an effect on the damage results obtained when employing archaic hand weapons and unarmed hand to hand combat. Characters who intend to operate in this capacity should consider this statistic carefully.

**MANUAL DEXTERITY**

Manual dexterity is a prerequisite for surgery, mechanics, or any skill requiring hand-eye coordination. A low score assumes that the character is clumsy when handling things. Furthermore, manual dexterity score has a limited effect on an individual's ability to use range weapons. **Manual dexterity has absolutely no effect on hand held weapons such as swords.** The relative effects of manual dexterity are given in the appropriate table.

**I.Q.**

I.Q. (intelligence quotient) is the most important vital statistic in *Battlelords of the 23rd Century*. It encompasses reason, learning, and artistic ability. It also affects the ability to comprehend languages. I.Q. is a prerequisite for Mutzachan, Chatlian, and Zen Rigel character races. It represents the mental power of an individual and therefore has a direct affect on the number of special powers that he can learn. Characters with high I.Q. scores gain bonuses to power points when generating. Low I.Q. limits the amount and type of occupational skills that a character may choose to learn. Characters may raise their I.Q. permanently by using the drug TDX-Enzy. The drug costs 10,000cr per two points of additional I.Q. to be gained. No more than 1 dose can be taken in a one month period. There is also a 15% cumulative chance of BRAIN HEMORRHAGING per additional dosage consumed. When brain hemorrhaging occurs, 2-12 points of I.Q. are lost permanently.

**AGILITY**

Agility measures reflexes, quickness, and balance. It is used primarily to determine attack initiative and reaction time. Initiative determines which individual moves first in a combat situation. A character who is exceptionally quick is able to draw or fire his weapon first. Reaction time measures the amount of time that must pass before a character is able to react to events that transpire around him. Reaction and attack adjustments are determined by rolling a d10, then adding or subtracting the given modifier as detailed in the Agility table. **The person with the lowest aggregate score always attacks first.**

Initiative also affects generation. A matrix controller adds his initiative score to the time it takes to generate a power. All powers require at least 1 second to generate, and thus MCs almost always attack last in combat.

**CONSTITUTION**

Constitution describes a character's physical fitness, health, and bodily resistance to disease and infection. Constitution also affects a character's body points. Constitution has 5 distinct aspects. The system shock number equates to the body's ability to deal with drastic amounts of pain. **Every time a character take a critical hit, he must roll under his system shock number or fall unconscious.** The Resurrection Percentage denotes the chance to revive a character who has died. Characters die when their body points drop below their Death's Door number.

A character can have his constitution raised by using body enhancement drugs such as DNA-5 and BS-231 (SEE the Body Points skill in Chapter 4). Characters should note that the cost of these drugs is prohibitively high and enhancement is limited. Characters must spend 2 weeks at the proper medical facility to receive the additional points. Finally, PCs can find natural means of increasing their constitution by following a vigorous program of running and lifting.

Each additional level of body points bestows a 03% increase in System Shock and Resurrection Percentage, along with a 02% increase in SMR rolls (except mental). It is not possible by any means, natural or otherwise, to raise constitution scores above the racial maximum. Not in this book anyhow!

**AGGRESSION**

If you are predisposed towards beating people up and enjoy the idea of putting various parts of their bodies through brick walls, then you probably have a high aggression score. Aggression measures the tendency for a particular individual to attack another under provocation. Violent characters tend to go berserk. If a character goes berserk, he gains a "wreaking havoc" bonus of +3 damage, and double the attacks per round when attacking with hand weapons or employing Hand to Hand (HTH) combat skill. Berserkers suffer a parry penalty of 25% and aim weapons at a -15 penalty. A berserk character may fight to -1 to -6 body points before collapsing. Roll a d6 to determine the point of collapse. **The base chance for a character to go berserk equals 01% per point of aggression above 80.** Eridani never incur any penalties when berserking or turning suicidal.

Characters with aggression scores above 105 are particularly volatile. They tend to turn suicidal when attacking. **There is a 01% chance to turn suicidal per point of Aggression above 105.** If a character becomes suicidal, he gains double his normal attacks per round, and a +5 damage bonus when using archaic hand weapons or hand to hand combat skill. A suicidal character uses ranged weapons at a -30 penalty to hit, and will not parry in any way. He fights into the negative body points, right up until the point where he dies. He often attacks party members after he "slags" whatever annoyed him in the first place. Whenever there is the possibility of a suicidal PC attacking a fellow party, he must make an Intuition check at a -10.

Individuals with aggression scores below 35 are considered timid and have a 01% chance per point below 35 to panic in the face of imminent danger.

**THERE IS NO TABLE FOR AGGRESSION!!!**

**INTUITION**

Intuition describes a character's sixth sense. It is the ability to feel what is the best answer to a dilemma without having much information. It is of utmost importance in situations where the best choice isn't clear. Intuition has a direct effect on a character's ability to resist mental attacks, and to perceive clues.

**CHARISMA**

Charisma is a measure of one's physical attractiveness, charm, and sense of humor. It is important because it represents the ability to get along with others. It also denotes base loyalty of all hirelings. Finally, Charisma reflects the attitude of the galactic masses toward the character. It is 15 points higher when the character deals with his own race. Charisma is the ONLY statistic which can be negative.

**SECONDARY STATISTICS**

**TERRESTRIAL KNOWLEDGE**

It seems necessary that individuals travelling around the galaxy would possess a certain amount of knowledge about the universe. Terrestrial Knowledge is a measure of an individual's knowledge about a given aspect of the galaxy. To determine the score, roll percentile dice and divide the number by three. This is the percentage chance that a character will know something about a specific planet. Characters operating in their own quadrant of the galaxy gain a +25% modifier to Terrestrial Knowledge checks. A character in his own system gains a +50% modifier. A dice roll above 98 always indicates a failure to know something. Terrestrial Knowledge scores can never be less than 01%.

**MILITARY LEADERSHIP**

Some of us can lead better than others. Military leadership is a measure of an individual's ability to lead combat troops. Combat troops are well trained, disciplined, and react properly under heavy stress. Characters who aren't proficient may lead non-combat troops, however with a significant penalty modifier incurred to Control checks. Non-combat troops don't usually remain calm when death is raining down all around them. Rank carries a certain amount of respect. As characters successfully lead more and more troops, their military leadership score increases. To determine an individual's military leadership qualifications, add his respective intelligence, aggression, and intuition scores, then divide by 4.

Military leadership increases at a rate of 03% per mission completed for the leader. Subordinates have their military leadership scores increase by 01% per mission completed. If a soldier panics, a military leadership check is made to see if the leader can control him.

**PERSUASION**

The ability to influence people's decisions. It is the hallmark of Orion Rogues who are known as charmers. Persuasion checks are modified by situation and a successful persuasion check indicates that the individual generally agrees with the character's idea. Persuasion equals I.Q. + Charisma divided by three. Modifiers are then applied.

**BARGAINING**

This isn't the same as Persuasion, although they are similar. Bargaining is the talent of driving a hard sale to obtain an important item or piece of information. This is a strong "suit" for Humans and Orion Rogues. Bargaining allows one to obtain deals on used goods. The going rate of exchange is typically 25-40% of the retail value. For each point that a character rolls beneath his bargaining skill, he gains a 01% increase to the base return of from 25% up to a maximum of 40% Gen-Humans are able to bargain up to 65% of the retail value, whereas Orions and Humans are able to get up to 75% back. Bargaining score equals Persuasion minus 15 points.

**STATISTICS TABLES**

**STRENGTH**

**Encumbrance:** Light/Medium/Severe. The number represents the maximum weight under these conditions. A character carrying half his light encumbrance value is considered unencumbered.

**Dam:** Damage Adjustment. Represents the additional damage done for archaic hand or weapons combat.

**SB:** Skill Bonus. The bonus applied to any strength based skill check.

**STRENGTH**

SCORE	ENC	DAM	SB	Mil. Press	Squat	Dead Lift
01-10	05/20/60	-4	-80	20	40	60
11-20	10/30/70	-2	-40	30	60	90
21-30	15/40/80	-1	-20	45	90	135
31-40	20/50/90	0	-05	60	120	180
41-50	25/60/100	0	00	80	160	240
51-60	30/70/110	0	00	100	200	300
61-70	35/80/120	+1	+03	125	250	375
71-80	40/90/130	+1	+06	150	300	450
81-90	45/100/140	+2	+09	180	360	540
91-100	50/110/150	+2	+12	220	440	660
101-110	55/120/160	+3	+15	260	520	780
111-120	60/130/170	+3	+18	310	620	930
121-130	65/140/180	+4	+21	370	740	1110
131-140	70/150/190	+5	+24	430	860	1290
141-150	75/160/200	+6	+27	500	1000	1500

**NOTE!!!** Encumbrance and damage is doubled for both Python races. This is due to the fact that Pythons are capable of lifting the front end of a Sandbuggy. Mazians have no skeletal structure and all encumbrance values for the Changeling are therefore halved.

**STRENGTH LIMITATION TABLE**

SCORE	GENERAL INFORMATION
01-10	Pretty feeble. Walking is a real feat
11-20	Characters can only be Mutzachan
21-30	Minimum strength for a Zen Rigeln, Mazian, or Chatilian
31-40	Minimum strength for an Orion, Human, or Gen-Human
41-50	Minimum strength for a Phentari
51-60	Minimum strength for a Cizerack and an Eridani
61-70	Minimum strength for a Python Lizard
71-80	Maximum strength for a Mutzachan and a Mazian Minimum for a Ram Python
81-90	
91-100	Maximum strength for an Orion, Chatilian, or a Zen Rigeln
101-110	Maximum strength for a Human or Phentari
111-120	Maximum strength for a Gen-Human
121-130	Maximum strength for a Cizerack and Eridani
131-140	Maximum strength for a Python Lizard
141-150	Maximum strength for a Ram Python

**MANUAL DEXTERITY**

**AB:** Attack Bonus. The attack bonus is applied to all ranged weapons when determining the Attack Number for combat.

**SB:** Skill Bonus. The modifier is added to skill related tasks requiring manual dexterity.

**MANUAL DEXTERITY**

SCORE	AB	SB	Notes
01-10	-40	-75	Okay so you can't hold a pen much less write
11-20	-20	-40	You're a KLUTZ
21-30	-10	-25	
31-40	-05	-10	Don't try any video games. You'll get hurt
41-50	-02	-05	
51-60	00	00	Average
61-70	00	00	
71-80	+01	+05	You're good with your hands
81-90	+02	+10	
91-100	+04	+15	Qualified for brain surgery
101-110	+06	+20	
111-120	+08	+25	
121-130	+10	+30	Concert pianist
131-140	+11	+35	
141-150	+12	+40	World's greatest pick pocket

**I.Q.**

**PWR Points:** Represents the internal power that a character can harness when using matrices. Add this to the power point total.

**Lang:** This denotes the number of languages that a PC can learn.

**SB:** Percentage bonus to perform tasks which are IQ related.

**I.Q. TABLE**

SCORE	PTS	LANG	SB	GENERAL INFORMATION
01-10	N/A	N/A	-100	Individual is a vegetable. Plant him
10-20	N/A	0	-75	PC can only be a Ram Python or Python Lizard. (You drool a lot and look slack-eyed and silly)
21-30	N/A	0	-50	Minimum I.Q. for learning occupational skills (It is still hopeless)
31-40	N/A	1	-25	May use archaic powder weapons
41-50	N/A	1	0	Occupations in military and vehicles
51-60	1	1	0	Minimum real I.Q. for most skills
61-70	1	2	+05	Occupations in sciences
71-80	2	4	+10	Occupations in cybernetics
81-90	2	6	+15	Maximum I.Q. for both Pythons
91-100	3	8	+20	Maximum I.Q. for an Orion
101-110	3	10	+25	Maximum I.Q. for a Human or Eridani
111-120	4	12	+30	Maximum I.Q. for a Gen or Cizerack
121-130	4	14	+35	Maximum I.Q. for Zen Rigeln or a Phentari
131-140	5	16	+40	Maximum I.Q. for a Chatilian
141-150	5	18	+45	Maximum I.Q. for a Mutzachan

**AGILITY**

**IM:** Initiative modifier. The number added to each dice roll when determining the combat initiative.

**DM:** Defensive modifier. The number that is added to the dice roll when determining the Total Attack Number to hit the character.

**SB:** Percentage bonus to perform an agility related task.

**AB:** The attack bonus is applied to all archaic hand held weapons. This number is added to the chance for a successful attack, parry, or special maneuver while engaged in hand to hand combat.

**AGILITY TABLE**

SCORE	GENERAL INFORMATION	IM	DM	SB	AB
01-14	Character is virtually helpless and immobile	N/A	+100	-90	-20
15-22	Character can be a Chatilian, or a Python Lizard	+10	+80	-70	-15
23-30	Minimum agility for Phentari and Ram Python	+8	+60	-50	-10
31-38	Minimum agility for an Eridani or an Orion Rogue	+4	+40	-25	-06
39-46	Minimum agility for a Zen Rigeln, Human, or a Gen-Human	+2	+20	-15	-02
47-54	Minimum agility for a Mutzachan	0	00	-05	00
55-62	Minimum agility for Cizerack	0	00	00	00
63-70		0	00	00	+02
71-78		0	-02	+02	+04
79-86		-1	-04	+04	+06
87-94		-1	-06	+06	+08
95-102		-2	-08	+08	+10
103-110	Maximum agility for a Python	-2	-10	+10	+12
111-118	Maximum agility for a Mazian	-3	-12	+12	+14
119-126	Maximum agility for an Eridani or an Orion Rogue	-3	-14	+14	+16
127-130	Maximum agility for a Zen Rigeln, Chatilian, and a Mutzachan	-4	-16	+16	+18
131-134		-4	-18	+18	+20
135-138	Maximum agility for a Phentari	-5	-20	+20	+22
139-142		-5	-22	+22	+24
143-146		-6	-24	+24	+26
147-150	Maximum agility for a Cizerack	-7	-26	+26	+28

**CONSTITUTION**

**SS:** System Shock. The percentage chance of a character remaining conscious after critical injury.

**RP:** Resurrection Percentage. Represents the percentage chance to restore life to a dead character.

**DD:** Death's Door. Death normally occurs at -10 body points. This is modified by constitution. Death's Door represents the point at which a character "bites the big one".

**BP:** Body Points added to the character's total.

**SMR:** Survival Matrix Roll adjustment. Doesn't apply to mental SMR.

**CONSTITUTION TABLE**

SCORE	GENERAL INFORMATION	SS	RP	DD	BP	SMR
01-10	Character can only be a Mutzachan	32	30	-5	-4	-08
11-20	Minimum for a Mazian or a Chatilian	38	35	-6	-3	-06
21-30	Minimum for a Human or Orion	44	40	-7	-2	-04
31-40	Minimum for an Eridani, Cizerack Gen-Human, or Zen Rigeln	50	45	-8	-1	-02
41-50	Minimum for a Phentari	56	50	-9	0	00
51-60	Minimum for either Python race	62	55	-10	0	+02
61-70		68	60	-10	0	+04
71-80		72	65	-11	+1	+06
81-90	Maximum for a Chatilian, Mazian or a Mutzachan	78	70	-12	+2	+08
91-100	Maximum for a Human or an Orion Rogue	84	75	-13	+3	+10
101-110	Maximum for an Eridani	90	80	-14	+4	+12
111-120	Maximum for a Zen or a Gen-Human	93	85	-15	+5	+14
121-130	Maximum for a Phentari	96	90	-16	+6	+16
131-140	Maximum for a Cizerack or a Python Lizard	98	95	-17	+7	+18
141-150	Maximum for Ram Python	99	100	-18	+8	+20

**INTUITION**

**MB:** Mental Bonus. This number added to one's SMR vs mental attacks. This is also the number added to sighting, hearing, and smell checks. It is also added to intuition based skill checks.

**INTUITION TABLE**

SCORE	MB	General Description
01-10	-25	You define the concept "moron"
11-20	-20	You are absolutely clueless
21-30	-15	The title "Bone Head" seems fitting
31-40	-10	Not very swift, are you
41-50	-05	A little bit slow
51-60	00	Average intuition
61-70	+05	
71-80	+10	Precocious
81-90	+15	Your friends say you're shrewd
91-100	+20	
101-110	+25	
111-120	+30	You are sharp as a tack
121-130	+35	
131-140	+40	A clutch performer
141-150	+45	Sherlock Holmes watch out

### CHARISMA

**RM:** Reaction Modifier. Denotes a person's initial response to the PC. Remember, you never get a second chance to make a first impression!  
**LB:** Loyalty Base. Measures the base loyalty of hirelings.

#### CHARISMA TABLE

SCORE	GENERAL INFORMATION	RM	LB
-21-(-30)	You are "fuggly."	-50	-30
-11-(-20)	You are scary looking.	-40	-20
-01-(-10)	Gruesome.	-30	-10
00-10	Disgusting.	-20	00
11-20	You are ugly as !%\$&*.	-15	10
21-30	Not very attractive.	-10	20
31-40	Depends on lighting conditions.	-05	30
41-50	You're about average.	+00	40
51-60	You look cute!	+05	50
61-70	You are alluring.	+10	60
71-80	You look Hot!	+15	70
81-90	Magnetic.	+20	80
91-100	You look amazing. I am drooling!	+25	90
101-110	Stunning!	+30	100
111-120	People look upon you with deep awe.	+35	110
121-130	My number is.....	+40	120
131-140	Wow!	+45	130
141-150	The definition of a 12!	+50	140

### CHOOSING THE CHARACTER

Players may choose from 12 different races. Each race has modifiers to various vital statistics, due to different evolutionary traits. The Vital Statistic Comparison Table lists these modifications.

**STR:** Strength      **AGL:** Agility      **INT:** Intuition  
**IQ:** Intelligence Quotient    **CON:** Constitution      **CHR:** Charisma  
**MD:** Manual Dexterity    **AGR:** Aggression

#### VITAL STATISTIC COMPARISON TABLE

RACE	STR	IQ	MD	AGL	CON	AGR	INT	CHR
CHATILIAN	-15	+30	-10	+05	-10	+10	+10	-25
CIZERACK	+15	-05	-15	+35	+12	+20	—	+05
ERIDANI	+10	+10	+05	+20	+05	+15	-05	-10
GEN-HUMAN	+08	+07	+07	+10	+10	—	—	+10
HUMAN	—	—	—	—	—	—	—	—
MAZIAN	-20	+15	—	-30	-25	-15	-05	-10
MUTZACHAN	-15	+30	+05	—	-15	—	+15	+10
ORION ROGUE	—	—	+20	+05	—	—	+20	+20
PHENTARI	-05	+12	+25	+05	-05	+20	+05	-35
PYTHON	+30	-10	-25	-05	+30	+30	-10	-30
RAM PYTHON	+40	-20	-25	+15	+30	+30	-15	-30
ZEN RIGELN	-05	+20	—	-05	+10	-25	+05	+20

### SECONDARY STATISTIC COMPARISON

**TER:** Terrestrial Knowledge      **MIL:** Military Leadership  
**PER:** Persuasion      **BAR:** Bargaining

RACE	TER	MIL	PER	BAR
CHATILIAN	+05	-05	-10	-10
CIZERACK	+05	+10	—	—
ERIDANI	+15	+20	-05	—
GEN-HUMAN	+20	+05	+10	+10
HUMAN	+15	—	+15	+25
MAZIAN	-10	-20	-10	—
MUTZACHAN	+10	-05	—	+05
ORION ROGUE	+25	—	+15	+20
PHENTARI	+15	+10	-20	—
PYTHON LIZARD	-20	+15	-05	—
RAM PYTHON	-20	+20	-05	—
ZEN RIGELN	-15	-10	+10	—

### RACIAL PREFERENCE

The Galactic Humanities Board has tried to iron out the differences between the many nations for years with little success. Only in the Galactic Forces, where individuals are forced against their wills to get along with each other, is there a basic homogeneous liking for one another. Racism and prejudice are rampant throughout the Alliance. In the past, many nations have been conquered by one another. The resentment still runs thick in the blood of the Alliance subjects. Below is given the basic preferences and attitudes of the different races toward each other.

The following table specifies the general racial preferences of the various races. It reads across. The race under inspection is denoted by the vertical component of the chart. The table only represents the tendency of a race to like or dislike another.



#### RACIAL PREFERENCE TABLE

	C	G	M	R	Z
C	H	E	U	P	M
H	A	I	E	N	T
A	T	Z	R	M	Z
T	I	E	I	H	H
I	L	R	D	U	U
L	I	A	A	M	M
A	A	C	N	A	A
N	N	K	I	N	N
CHATILIAN	P	T	D	D	D
CIZERACK	T	P	D	T	T
ERIDANI	D	D	P	T	T
GEN-HUMAN	M	T	T	P	T
HUMAN	M	T	T	M	P
MAZIAN	E	P	T	T	T
MUTZACHAN	D	T	T	P	T
ORION ROGUE	T	T	E	P	P
PHENTARI	D	M	E	T	D
PYTHON	D	E	P	T	D
RAM PYTHON	D	E	T	T	D
ZEN RIGELN	T	D	D	P	P
TZA ZEN	D	D	P	D	D

P=Preferred T=Tolerant M=Mistrust D=Dislike E=Enmity

NOTE!!! These represent general tendencies of how the races view of one another. It is NOT absolute nor is it intended to be. It merely represents the general attitudes of races toward each other.

**CHATILIAN EMPATH**

CHE-teel-yen EM-path

**VITAL STATISTICS**

-15	Strength
+30	I.Q.
-10	Manual Dexterity
+05	Agility
-10	Constitution
+10	Aggression
+10	Intuition
-25	Charisma

**SECONDARY STATISTICS**

+05	Terrestrial Knowledge
-05	Military Leadership
-10	Persuasion
-10	Bargaining

**SPECIAL ABILITIES**

Matrix control  
Telepathy

**LIABILITIES**

Must pay more for helmets  
Helmets interfere with generating ability

**GENERAL OCCUPATION**

Counter Espionage

**GENERAL KNOWLEDGE:** Although mockingly nicknamed "Asparagus Men", these guys are tough. They aren't liked very much, but most intelligent people don't "mess" with them. The Chatilians are from the planet Chatil in the Fomalhaut star system. They are frail, delicate looking, greenish blue beings with thin bodies and large, bullet shaped heads. The skull is crowned with sensory nodes which allows these strange beings to generate matrices. Chatilians are herbivores. They have no real mouth, rather they possess facial slits through which they strain their food intake.

The Chatilian Empaths communicate among themselves telepathically and have great difficulty learning to speak aloud. They must pay two extra proficiency points when opting to learn any spoken language skill. Although empathes are innocuous looking, they are actually among the more dangerous and formidable opponents in the galaxies. Through the evolutionary process, they have developed psycho-kinetic power which allows them to harness and transmit psychic energy. This unusual ability is called "generating". Chatilian special powers are some of the most potent in the game. Their energy matrices are multi-faceted, allowing them to react differently to a variety of situations. Empaths employ psychic, illusionary, and sonic attack forms. High level Chatilians can actually crush the minds of their enemies. Finally, highly intelligent Asparagus receive extra power points for use in the generation of their special powers.

The energy for "generation" is focused in the power crystal which a Chatilian always wears on a chain around his neck. Without the crystal, the empath is impotent, so most empathes carry a backup crystal, just in case they should lose the first one. An empath has the innate ability to read the minds of any unprotected sentient being within 2m of his person. He must focus his attention on one person only.

It is difficult for Chatilians to generate while wearing helmets. The cost to generate is doubled. Helmets must be custom designed to fit an Asparagus's oblong head. Consequently, Chatilians pay 25% above the stated retail cost for any helmet.

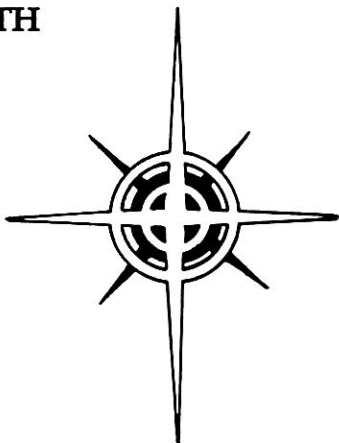

**GOVERNMENT:** Chatil is presently ruled by the aging King Atish Catam. The monarch's power and authority is balanced by the People's Parliament. Any law passed by the king must receive a 2/3 vote of support from the parliament, which is set up in such a way that the representatives of each state hold votes in direct proportion to the amount of residents there. The Chatilian government supports the Alliance as long as its sovereignty is preserved and the Chatilian populace view outsiders with a mix of condescension and envy.

**CULTURE:** The culture is one of openness. This isn't because most empathes want it that way, but because those who possess "The Power" have the ability to read each others' minds. Privacy is a premium and most empathes want privacy, but can't seem to find it anywhere. The constant psychic-babble is intolerable to those who can't shut all of the noise out. Chatilians often hang out in closets and if you have lost your Chatilian, then I suggest that you go look for him there.

Take note that the Chatilian masses do not possess the ability to generate and view "The Power" as something corrupt and decadent. Empaths, on the other hand, see the masses as inferior, attempting to subjugate their own people to their naturally superior intellect. Consequently, the king (whose hereditary line possesses "The Power") must continuously seek to avert a civil war among his own people.

**PHYSIOLOGICAL MAKEUP:** These herbivores are inherently weak and their digestive system is such that they can survive by eating only plants, roots, and other strange goodies. Chatilians live to be 300 years old. They reproduce every 20 years and many go into "false heat" every couple of months. When this happens, the empathes become irritable and detached, retreating far into themselves.

**WEAKNESS:** Tough as the empathes are mentally, they can be hypnotised rather easily and suffer a -35 to mental SMRs. The most notable means of hypnotising a Chatilian is by playing the Souc Harp. This melodic instrument is somewhat similar to the ancient Earth equivalent.

**QUIRKS:** Chatilians love to just "hang out" and think. There is nothing better than a little introspection. Empaths have an unquenchable thirst for knowledge and they love libraries, finding them the most relaxing of all places to visit. Humans go to the movies on Sunday, while Chatilians take the kids to the library.

Empaths make a strange, high pitched, whining sound when they are agitated. The Galactic masses call this the Chatilian War Cry and although they are normally difficult to arouse, an angered empath can be quite frightening. They secrete a thick, yellow, viscous liquid that flows from the slits in their mouth while their huge eyes appear to bulge from the sockets. By the way: the Chatilian starts drooling right about the time he begins "generating," and you begin dying.

Empaths whine more by nine o'clock than most people do all day!

**HISTORY:** Lord Makov Chatil, the first Chatilian Empath, developed psycho-kinetic power around the year 12,180 B.C. Awed and yet humbled, he took to the streets to teach the people. The knowledge of "The Power" spread and those who possessed this latent ability were called Illuminaries. They were the focus of adulation and resentment within the Chatilian culture. Schools were set up to teach those blessed with the gift.

Upon Makov Chatil's death in 12,097 B.C., Cashan of Lamir took the throne. He outlawed psychic power, denouncing it as the Demon Thought, and so began the systematic extermination of the empathes. The "Illuminaries," as they were self called, fled for their lives, seeking refuge in the twisted labyrinthine passages of the Caves of Darkness. For decades they huddled in the desolation and many starved to death. Yet resolute was their determination to teach the young.

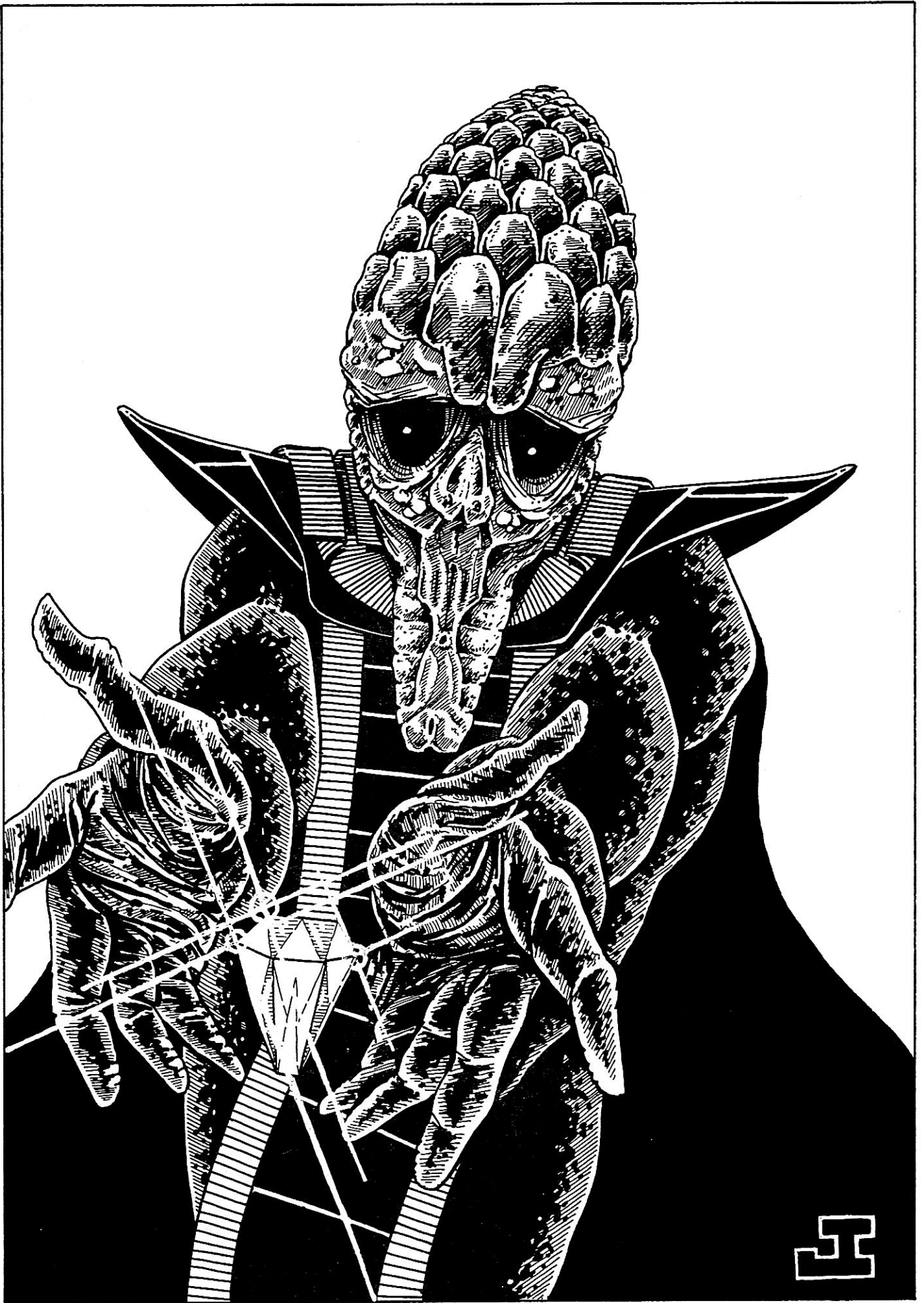

3

In 8911 B.C. after 2,000 years in darkness, the Illuminaries struck back, leading an attack on the Normals at the Palace of Patru. So began the Chatilian Civil War. Finally, 57 years later and at the cost of some 2,000,000 lives, the Illuminaries won the decisive Battle of the Morkudom.

Over the years, the wisdom Lord Makov Chatil brought to the Chatilian people has been lost, suppressed by the inherent distrust of empaths toward each other. Moreover, the Chatilian society views itself as superior to the rest of its galactic counterparts. Empaths are greatly feared by the Galactic masses who find them repulsive to look at and not very trustworthy. (Most individuals don't appreciate having their mind read.) In 2103, the Galactic Alliance passed into law the Brain Trust Acts which contained the provision that all Chatilian empaths must display their power crystal at all times. Failure to do so can result in imprisonment.

**FAVORITE ITEM:** The Chatilians' favorite item is his Brain Scratcher. Why would anyone leave home without it.

**DRESS:** The Empaths love the color green and wear it constantly. Chatilians like hats as well and there are hundreds of different types of head attire available.

**HANGOUTS:** Chatilians are not very social and generally prefer to be by themselves. Normally one can find them in isolated places where few travel. However, if in their company long enough, most adventurers find that empaths continuously whine about the state of affairs and never shut up!!!

Every 5 years, all Chatilian empaths make a pilgrimage to the Caves of Darkness where they pay respects at the Shrine of the Illuminaries.

**ABODE:** The Chatilian empath home is very cozy, filled with a multitude of knick-knacks and other items that give their abode a feeling of warmth and comfort. All walls are psionic proof so that the house is quiet even when everyone is home. Empaths love books and most affluent Chatilian homes contain a large library.

**COMBAT TACTICS:** Asparagus Heads prefer surprise mental attack forms to take out the enemy without exposing themselves to harms way. The majority of empaths agree that using Resonant Structure on a target is the most fun! (The Chatilian generates a resonant frequency wave inside the skull of the enemy, causing the head to explode).

**GENERAL OCCUPATION:** Empaths are generally employed as espionage and counter-espionage agents for the various spy networks. Their natural mind reading capacity makes them a valuable commodity and they can charge 30% above the normal rate for their services as spies.

**VIEW ON LIFE:** Through the furthest development of the intellectual thought process, one can reap the fullest benefits of a transient existence.

**WAR:** Only those of inferior intellect find pleasure in engaging in the barbaric, vulgar, duress of war. Those of superior mental strength can avoid such folly.

**ALLIANCE:** A necessary evil. The lesser masses must be posted to their natural position in things. This can only be obtained through a governmental structure.

**UNIVERSE:** This endless realm must be explored and cultivated so that it may be fully understood.

**FAMILY:** This succinct body exists to perpetuate the evolutionary process and is integral in the formation of the self. It is therefore relevant.

**THE SELF:** I am the product of my thought. I am only relevant in as much as I have the ability to manipulate my awareness and expand the boundaries of my mind.

**NOTABLE CHATILIAN STATEMENTS**

I rather like the way his head exploded.  
I am not whining. Shut up or...Ahh!  
You are now my friend.

**CIZERACK**

SIZ-er-ak

**VITAL STATISTICS**

- +15 Strength
- 05 I.Q.
- 15 Manual Dexterity
- +35 Agility
- +12 Constitution
- +20 Aggression
- +05 Charisma

**SECONDARY STATISTICS**

- +05 Terrestrial Knowledge
- +10 Military Leadership

**SPECIAL ABILITIES**

- 2nd level Acrobatics
- Exceptional hearing and sight
- Night Vision
- Leap
- 4th level Stealth

**LIABILITIES**

- Sensitive to sonic attacks
- 60 Agility when standing on 2 legs

**GENERAL OCCUPATION**

Scout



**GENERAL KNOWLEDGE:** Lithe, strong, and fast are the three words that best describe this race of felines. The Cizerack are a race of large, blue/black cat-like creatures, indigenous to the planet Cashoulis of the Antares star system. Like all cats, the Cizerack are extremely fast and nimble, able to achieve speeds of 80kph for short periods of time. They begin the game with 2nd level proficiency in Acrobatics, and can leap vertically up to 3m and horizontally up to 5m. Evolution has brought on the ability to walk erect, as well as on all fours. When standing erect, the Cizerack is always size class 7 and her agility score is reduced by 60 points. The felines are considered size class 7 for purposes of purchasing armor.

Most Cizerack resemble giant hyenas, although there are species similar to panthers and lions. They possess steel gray eyes from which comes the statement, "Beware the eyes of the Cat". Cizerack have incredible hearing and vision. The felines are also formidable in weaponless combat, gaining three attacks per round: claw, claw, bite. One complete open hand attack from this race can kill a typical human with ease.

They are a match for any other race, possessing excellent balance, incredible speed, and superior agility. Felines can take a lot of damage before being dispatched to the heavens. Cizerack, however, do have low manual dexterity scores which generally prohibits them





from learning certain occupational skills that require deftness of hand. They possess prehensile paws, with extendable/retractable fingers, without which the cats would never have been able to develop such a sophisticated, technologically advanced society.

**GOVERNMENT:** The Cizerack government is clan-like. The matriarchy is set up so that the oldest females rule the society. The cats are strongly territorial, each clan controlling a section of land, headed by the Ratum Ala ("den mother"). The Cizerack society functions, but is plagued by continual fighting over territorial sovereignty. The most powerful clan is the Fenib Maturt. There exist some 200,000 Fenib panthers.

**CULTURE:** Cizerack culture stresses discipline and knowledge. The young females are sent to school where they are taught Damack Hatib ("The Code of Living"). This code stresses individualism, freedom, and the work ethic. "Any good feline is a working feline." Female cats are taught the value of their own self and that of the clan. Note!! A powerful dichotomy exists between the sexes of this race. While the females are revered, the male Cizerack are kept as ignorant slaves, existing to perpetuate the race and perform menial labor.

**PHYSIOLOGICAL MAKEUP:** A Cizerack cat is prolific, reproducing every year or so, and when a Cizerack goes into heat, she becomes irrational and violent. She needs to be fulfilled, whatever the cost and there have been documented cases where a cat has become so "heated" that she actually took a non-Cizerack to serve her. Her biological cycle is such that she usually knows when her time is approaching and journeys home to take her mate. After she gives birth, the Cizerack often kills the male.

Cizerack have special vision. Their eyes filter out and enhance ambient light sources so that the cat can see equally well at night as during the day. Evolution has brought about a strange occurrence. Their eyes contain a small biological organism that reacts with its environment to produce faint glowing light. Thus, the cat's eyes actually glow in the dark. Scientists reflect that this is due to the fact that the planet Cashoulis has an inordinately long winter where darkness prevails for up to seven months at a time. Life Expectancy: 65 years.

**WEAKNESS:** The Cizerack ears are well documented for their sonic sensitivity. Krosh the Python, a genius scientist (if you can believe that) invented a powerful tuning fork. The tuning fork resonates at such a high frequency that only the cat can hear it. The weapon has the same effect as a sonic disruptor. It has a range of 50m and costs 2,000cr.

**QUIRKS:** The cats are carnivores and prefer a diet of meat, as opposed to vegetables or synthetics. The sight of RED blood has a powerful effect on them and the cats become enraged. There is a 05% base chance that the Cizerack will attack a bleeding person outright. So if you are a Human and get hurt while hanging around a cat, I suggest quite strongly that you get your.....out of the area!

**HISTORY:** The Cizerack's technological revolution occurred over a period of 1000 years because of the cat's poor manual dexterity. But never question the intestinal fortitude of these precocious females. As they say, "There isn't one thing that 10 males could do, that one good female couldn't do better."

Overcrowding forced Cizerack scientists to look to the stars and the Cizerack nation first developed space travel in 1600 B.C. Intergalactic space travel occurred in 97 A.D. Expeditionary fleets have charted all the star systems within 15 parsecs of the home planet.

The cats are blood enemies of the Python Lizards and Ram Pythons. In 1856, the Cizerack expeditionary fleet set out to colonize the Floridian system and encountered the barbaric race of lizards. Chatira the 3rd, high den mother of Cashoulis, sought to elevate the Python nation by bringing them the superior Cizerack equipment,

products, and culture. The den mother sent an emissary to the planet Pythos. The lizards brutally murdered the goodwill ambassador at Makel and the enraged feline ordered the invasion of the lizard planet. The Cizerack/Python War lasted almost a hundred years.

The Cizerack also encountered the Mazians. In fact, they discovered the amoebae long before they stumbled upon the lizards. The two share an amicable relationship. The amoebae often ride the cats. Strange!!!

**FAVORITE ITEM:** If the cat has a soft spot, it is the desire for soft things. "I am a female after all." The cats love pillows and other soft, squeezable objects.

**HANGOUT:** This race enjoys to roam about prairies and savannahs. Cizerack love nature and the outdoors. They are not at home in cities and other crowded places. The favorite Cizerack vacationing spot is the Przar Wildlife preserve on Pishalis.

**DRESS:** The cats wear few clothes, unless the temperature drops below -10 celsius or so. They enjoy leather crafts such as studded neck collars and spiked paw bands.

**ABODE:** The Cizerack home is usually a modest but comfortable cave-like structure called a Wewh. Most Wewhs are multi-tiered and maintain spacious rooms which the cats fill with throw pillows. Otherwise there is not much furniture to be found in a Cizerack home.

**COMBAT TACTICS:** The cat prefers to utilize her inherent speed when operating in combat situations. She generally carries a look-n-shoot weapons system mounted to her back so that she can engage the enemy on the "fly."

**GENERAL OCCUPATION:** Cizerack tend to follow a strict interpretation of law and order and are often found as leaders of long range reconnaissance patrols where their inherent speed can be properly utilized in open terrain.

**VIEW ON LIFE:** I shall raise my kittens to great warriors. My service to life is to myself and my kindred.

**WAR:** It is on the battle field that the swift and the strong belong. Finesse is the natural conqueror of force.

**ALLIANCE:** The government is designed for the betterment of all. Its ideals shouldn't be questioned.

**UNIVERSE:** The Cizerack nation and the Alliance must prevail.

**THE FAMILY:** My cubs shall grow to be great leaders.

**THE SELF:** I am queen wherever I roam. Males merely supply my entertainment.

#### **NOTABLE CIZERACK STATEMENTS**

I'm the queen bitch around here.

You males are absolutely pathetic.

I am faster than a speeding skimmer and superior to any Ram Python.

**ERIDANI**

Air-eh-DON-ee

**VITAL STATISTICS**

- +10 Strength
- +10 I.Q.
- +05 Manual Dexterity
- +20 Agility
- +05 Constitution
- +15 Aggression
- 05 Intuition
- 10 Charisma

**SECONDARY STATISTICS**

- +15 Terrestrial Knowledge
- +20 Military Leadership
- 05 Persuasion

**SPECIAL ABILITIES**

- 2nd level Body Equilibrium
- 3rd level Archaic Hand Weapon (usually sword)
- Archaic Hand Weapon skills cost one less
- Infravision

**LIABILITIES**

- Must wear atmospheric processor
- 40 proficiency skill slots

**GENERAL OCCUPATION**

Combat Specialist

**GENERAL KNOWLEDGE:** The ultimate warrior. The methane breathing Eridani is the epitome of a combat tactician. He possesses supreme agility, exceptional willpower, and is quite cunning. This warrior specializes in combat skills, most notably archaic hand weapons. He is affectionately called "Swordsaint" and begins the game with 3rd level proficiency in the archaic hand weapon of his choice, typically sword. This race is the only member of the Council of Timar that can carry a weapon on a planet that forbids such technology. Every Swordsaint is allowed to carry an ornamental long sword wherever he goes within Alliance territory. Eridani also begin the game with 2nd level proficiency in Body Equilibrium, for the warriors study Kaush-mukal (The study of the Inner Self).

Certain Eridani are chosen at birth to fulfill the honorable status of Mokaba Datu, (Wisdom Warrior). They are taken from their cribs and raised by the Buddon priests who are former Mokaba Datu. In life, the Buddon priests had reached the highest level of internal knowledge, Rota Mabiki (Supreme Peace) and the most powerful of Buddon ranks are chosen to become the caretakers of the future.

Under the tutelage of the Buddon priest, the young Mokaba Datu learns the basic tactics of honorable survival. He is taught the fundamentals of archaic hand weapons combat, drilling every day for hours, until he passes a fundamental competence test in his chosen weapon. Eridani receive one extra attack per combat round (three seconds) when fighting with Archaic Hand Weapons or in Hand to Hand combat.

Once the Mokaba Datu has mastered the fundamentals, he begins the arduous task of finding Goyoo-Mabiki (Silent Peace). Through long hours of meditation, under the supervision of his master, the Kimikasou (young warrior) seeks to harness this elusive power of the inner self. Once he has attained peace within himself, he has customized armor built for himself (+25-100%) of list cost.

A warrior has a duty, unselfish and detached. It is to wage battle for the honor of the race, and in the heart felt throes of battle come to understand the tentative existence of the self. A warrior must be willing to sacrifice emotion for the superior "conscience" of objective thought. This enables him to function appropriately. Even in a

berserk status, an Eridani retains complete control of himself and suffers no penalties. He does, however, benefit from any bonuses while berserking. Those unworthy of combat will inevitably be disposed of. Such is the fundamental construct of the evolution process. Eventually one must find the door to everlasting peace. But the path to tranquility starts in the chaos of the battlefield.

**GOVERNMENT:** Eridine is ruled by a military dictatorship, under General Erash-Ican. Erash is a realist and has allowed some external say in government matters. He has created two advisory bodies, the Scientific Forum and the Social Organization on Reform. These groups advise him on matters of state and public policy. The general understands the need for conflict and battle to "cleanse" the masses, but acknowledges the need for others to run the more mundane aspects of a warrior society. He spends a full 30% of the planet's gross planetary profits on military programs.

**CULTURE:** The Eridani society utilizes a class oriented hierarchy and there exist three different social classes, the Vax, Tolude, and lowly Mudig. The Vax run the planet and hold most offices and positions of power. They are composed of the Buddon priests, Mokaba Datu, and other military elitists. The Tolude represent the Eridani middle class. They have good paying jobs and are free to come and go as they please. These middle class Eridani understand the need for the hierarchical structure to exist and generally accept their place in society. The Mudig represent the Eridani lower class which is composed exclusively of the weak and naturally inferior specimens. The Mudig are enslaved from birth. They work out their generally short life spans in the mines.

**PHYSIOLOGICAL MAKEUP:** Eridani are tri-sexual beings. The males and the females impregnate the Nog who carry the child until birth. The Nog is the most respected and revered of the Eridani people. They never travel unescorted and any Eridani will give his life to protect them. The Nog look like fat, gelatinous, bipedal turtles.

Eridani live for up to 200 years and reproduce every 5 years.

The Eridani are methane breathers. Their planet atmosphere has a 22% methane content. When operating outside their home environment, the Swordsaint must wear an atmospheric processor. This processor extracts hydrogen from the air. It has a carbon block dispenser which is chemically activated to mix with the hydrogen to form methane. The block lasts for 4 months before it must be replaced. A new block costs 500cr.

Eridani die when they reach 1.5 times the normal death door. Furthermore, any critical hit which indicates instantaneous death, will only kill the Swordsaint if he fails to make a system shock roll at a minus 20 penalty. Exception, having your head removed doesn't count!

**WEAKNESS:** The Eridani are extremely susceptible to mercuric poisoning. Infected Swordsaints must make an SMR vs poison at a minus 15 or fall into a coma and die within 1-6 days. The Eridani government has lobbied intensely against the production of mercuric rounds so this ammunition is very difficult to find.

**QUIRKS:** Eridani are forever practicing intricate movements with their swords. A typical Swordsaint practices for three hours a day and another hour a day with various secondary weapons. Eridani often insist on firing their heavy weapons to make sure that they are still serviceable. They also see no problem with using live bait for target practice, so long as the target has shown himself dishonorable and thus deserving of death.

**HISTORY:** Eridani history is a painting of conquest and conflict. At one time Eridani battleships swept across the galaxy, engaging in the true rapture of battle. They defeated their noble adversaries and conquered star system after star system, taking to space like bees to honey. The race unsuspectingly encountered a tenacious race of



squids called the Phentari. This treacherous enemy, the Eridani could not easily defeat. The proud Eridani launched an all out offensive to vanquish the Squids. However, the Phentari had found a common ally in the Orion Rogues and together the two marshalled their forces and struck back at the Eridani home planet, reducing it to rubble. The Swordsaints have never lived down the humiliating defeat and the blood feud still exists today.

**FAVORITE ITEM:** "My favorite item is that which I have trained with since birth. This is only natural. In my case, I specialize in the application of the two handed sword."

**DRESS:** Eridani wear ceremonial armor most of the time. On rare occasions, a relaxing Swordsaint can be found lounging in a highly reflective skin suit.

**HANGOUT:** The Eridani spends his free time either meditating or working out at the gym. Most gyms contain holo-weapon facilities to simulate combat. If you are searching for an Eridani comrade, your best bet is the gym.

**ABODE:** The Swordsaint's home is a beautiful and elegant warehouse of weapons. Eridani are notorious for collecting strange and exotic weapons from all over the galaxy. They display weapon pieces in large, glass showcases. Swordsaints also love the semi-precious metal gold. They enjoy statues which can be found in large numbers scattered throughout the home, including the bathroom. Finally, the Swordsaint's abode is impeccably clean.

**COMBAT TACTICS:** Straight up and straight out! Eridani fight honorably and any Swordsaint who is found to act differently is hunted down and slain by his kindred in order to preserve the sanctity of the Swordsaint code of honor.

**GENERAL OCCUPATION:** Eridani function normally as Ninja-like assassins or warrior types. In either case, combat is always carried out with the utmost honor. They are adept at archaic hand weapons combat and learn new levels of proficiency at one point less than the norm (minimum cost: .5 points).

**VIEWS ON LIFE:** One must reach Rota Mabiki.

**WAR:** It is the ultimate test of the self.

**UNIVERSE:** It represents the grandest field for battle.

**ALLIANCE:** It merely is. Why isn't very important, as long as it is honorable.

**FAMILY:** It exists as a mold for future generations. The inferior are eliminated by the process of natural selection.

**SELF:** I am the ultimate warrior. My future is carved through the skill of my sword.

#### NOTABLE ERIDANI STATEMENTS

The steel of my sword cuts with the swiftness of a heart that is never dulled.

I hereby challenge you to a Duel.

I do not bleed because I refuse to!

## GEN-HUMAN

Jen-Hyoo-man

### VITAL STATISTICS

+08 Strength  
+07 I.Q.  
+07 Manual Dexterity  
+10 Agility  
+10 Constitution  
+10 Charisma



### SECONDARY SKILLS

+20 Terrestrial Knowledge  
+05 Military Leadership  
+10 Persuasion  
+10 Bargaining

### SPECIAL ABILITIES

Piloting skills cost 1 point less

### LIABILITIES

None

### GENERAL OCCUPATION

Any

**GENERAL KNOWLEDGE:** Take the best physical and mental traits of multiple human specimens and create a superior being. The result is a Gen-Human. The term "Gen-Human" stands for genetic Human. This genetic fusion represents the future of the human race. Genetic Humans are mentally and physically superior to their cousins, but the only accurate way to determine whether someone is a clone is by checking his scalp. All Gen-Humans are branded with a production number at "birth".

Many Clones are jealous of their fellow Humans, for they don't have an ancestry or heritage. They exist in a quasi-real paradox of existence. In many ways the clones are less than orphans, for Gen-Humans are grown in accelerated biochemical environment tanks, then given to special foster parents during the formative years. Hence, many Gen-Humans suffer from psychological disorders. As one Gen-Human philosopher said "We are merely synthetic products, nothing more than elegant looking robots". This haunting uncertainty has fostered much resentment between the Gens and Humans.

**GOVERNMENT:** The Gen-Humans believe in a wide variety of governments. The type of governmental structure supported depends entirely on the individual. What is certain is that most clones truly believe that they are pre-ordained to control the universe, a thought pattern that was woven into the DNA link of the prolific DB-7 and DB-8 Accelerated Response series. Gen-Humans hold the highest offices in the galaxy, including President of the Galactic Alliance.

**CULTURE:** Big Problem. Gen-Humans accept the culture of their cousins, but are aware that it doesn't belong to them. The fact that they are engineered in bio-chem labs precludes them from having a culture of their own. Many Gen-Humans seek out and marry unattractive Human mates. Many Genetic Humans like their significant other to be "fuggly." Even so, there is a certain aristocracy common among genetic clones.

**PHYSIOLOGICAL MAKEUP:** An inordinately high percentage of Gen-Humans suffer from schizophrenia, reclusive enteritis, or psychosis. Clones live to be 140 years old.

**WEAKNESS:** Gen-Humans are genetically manufactured. Consequently, much scientific investigation has been done on how to destroy them most effectively. The drug Phio-Sodium Augurate has



been synthesized to kill Gen-Humans. It attacks the brain, shorting out the neural-pathways. The drug induces convulsions, brain hemorrhaging, and involuntary muscle spasms. Affected persons lose 2-12 points of IQ and 2-12 points of constitution permanently. The drug is readily available on the Black Market.

**QUIRKS:** Genetic Humans possess the same quirks and idiosyncracies as Humans of the 20th Century.

**HISTORY:** As early as 1966, scientists began doing genetic experiments, mapping the DNA and RNA of mice and other lab specimens. By 1990, they had successfully cloned small rabbits, amidst a huge controversy concerning the right to create life. Was it right to play God? Eventually, scientific endeavor, fueled by the ulterior motives of the government, won out against the moral majority.

The holocaust of the 3rd World War left the planet in a state of chaos and shambles. It wasn't until the summer of 2011 when Dr. Katherine Dykeman completed a top secret government experiment for the United Socialist States of America. She cloned a human being in the bio-chem lab at Toronto New York. Scientists had created the first "super being"!

Immediately, the United Socialist States began large-scale cloning. By 2075, cloning was widespread and common in all nations on the planet Earth. The Genetic clones proved far superior to their counterparts, replacing them in the job market and private sector. Then in 2090, a backlash of anti-clonic sentiment swept the world and so began the devastating Clone Wars. For seven years Humans patrolled the streets and indiscriminately killed any person suspected of being a clone. Hundreds of thousands of innocents were slaughtered and finally in 2098 United Earth was forced to pass the heralded Clone Laws which stipulated that no more than 15% of the galaxy's population could be of clonic descent. All firms producing clones were forced to stamp the scalp with a model and serial number.

**FAVORITE ITEM:** Gen-Humans enjoy holo-rooms or holograms. The chic thing for yuppy Gen-Humans to have is a holographic picture of their "significant other". Holo-pictures sell for around a 1000cr.

**DRESS:** Clones usually wear skin suits. Many radical types wear an ancient and uncouth type of clothing called jeans.

**HANGOUT:** Many Gen-Humans make a special pilgrimage to the Orion Home world of Taos 4 every year. It was here that the Battle over the Sea of Orion took place and this sight is considered sacred to the Gen-Human cause. Visitors can go to the Monument of the Fallen Warriors, a floating museum in space where the destroyed hulls of the battlecruiser Valiant and the light cruiser New Providence still float. These tombs carried over 2000 martyrs to their death in the bid to stop the First Arachnid Invasion. A monument to the Wolverine Squadron stands here as a memorial to those brave souls who flew the heralded "Flight of the Valkyries" against the Arachnid ships, thus saving the Alliance.

**ABODE:** Gen-Human homes tend to be excessively lavish in their decor. There are pictures everywhere to remind them of themselves. Wealthy Gen homes contain holo-rooms.

**COMBAT TACTICS:** They take great pride in their military tactics. Many train at the Military Candidate School which has the reputation of fielding some of the greatest battle trained minds in the Alliance. Many Gen-Humans seek careers as officers in the various Galactic Defense forces.

**GENERAL OCCUPATION:** The Clones control the central government of the Alliance which produces all ships and vehicles used by combat troops throughout the galaxy. Thus, Gen-Humans and Humans pay a point less than the required proficiency slots when opting for training in the piloting of any vehicle.

**VIEW ON LIFE:** It is my destiny to create my own future, to be free to pursue that elusive dream which is the essence of my being.

**WAR:** War is a necessary evil to ensure the survival of the Alliance.

**UNIVERSE:** Beautiful and yet frightening.

**ALLIANCE:** The greatest single ruling body that has ever existed. It is the Rome of now.

**FAMILY:** Some confusion as to their real identities. They extol Dr. Dykeman as the 'mother of their souls.'

**SELF:** Questionable at times. Superior in form, but without culture, heritage, or past. "We are, yet we are not."

#### NOTABLE GEN-HUMAN STATEMENTS

Whatever happened to Rock-n-Roll?

It hurts more than you think not to know who or what you really are.

I am the 23rd Century Test Tube Man.

## HUMAN

Hyoo-man

#### VITAL STATISTICS

No Modifiers

#### SECONDARY STATISTICS

+15 Terrestrial Knowledge

+15 Persuasion

+25 Bargaining

#### SPECIAL ABILITIES

70 proficiency skill slots

Piloting skills cost 1 point less

#### LIABILITIES

None

#### GENERAL OCCUPATION

Pilot



**GENERAL KNOWLEDGE:** Humans may look like a weak character race to play at first, but they do have some distinct advantages over the other races. First of all, humans begin the game with more occupational proficiency points than any other race. Most races start with 50 or fewer proficiency points. Humans begin with 70! They are by far the most adaptable of all the races. Genetic science may have made the Gen-Humans mentally superior, but at the loss of some of the brain's inherent diversity. The trade off for having 70 points is that Human player characters don't receive any vital statistic bonuses. They do, however, have exceptional secondary statistics. As a matter of fact, they have the best in the game. When it comes to bargaining, Humans have no equal. Well, maybe the Orions.



By the way, the 2125 galactic census figure reported that there were 282.4 billion Humans within the Control Worlds.

The majority of Humans view the Galactic Alliance with disgust. It is seen as nothing more than an autocratic dictatorship, controlled by the Gen-Humans and Mutzachans. "The Alliance exists merely to create opulence for a few, at the expense of the masses". Some Humans have sided with the Rebel insurgents to fight the perversion. Although many are diametrically opposed to government policies and methods, most Humans realize that they are well off compared to the rest of the Alliance's peoples.

**GOVERNMENT:** Besides Gen-Humans, Humans control the most prestigious positions of power throughout the galaxy. Many contend that the normal Humans are less ego driven and care more about the "masses" as a whole. The claim is that Humans, not Gen-Humans should run the universe. Of course this is a subject of much contention.

**CULTURE:** Their culture is driven by a need to absolve itself of guilt from the nuclear holocaust that almost destroyed their home planet. Many people actively campaign against militarism. Otherwise, the various cultures of the future are as diverse and complex as those of the 20th Century.

**PHYSIOLOGICAL MAKEUP:** Humans are the same in almost all aspects as their 20th Century counterparts, except that their life expectancy has increased to around 120 years.

**WEAKNESS:** Humans possess the same frailties as they had in the 20th Century.

**QUIRKS:** They are Humans. Does anything more need to be said?

**HISTORY:** In the fall of 1999, the Russians and Americans faced the Nicaraguan Missile Crisis. The Russian-backed Sandinista regime wanted their Soviet allies to deploy short range nuclear weapons on Nicaraguan soil. The pretext for such a deployment was that the missiles were to protect Nicaragua from invasion from neighboring Panama. The Soviets went ahead with the deployment, against the outcry of threats and denunciations from the U.S. An ultimatum was finally given. "Remove the missiles or face a full-scale retaliatory nuclear strike!" The Russians backed off and quickly withdrew the missiles, finally recalling their ambassador to the U.S.

Shortly thereafter, nuclear devices were simultaneously detonated in Washington and New York, killing the President, The Secretary of Defense, the Ambassador to the United Nations, and some 150 members of Congress. The Russians denied responsibility. No immediate response came from the U.S. Then, suddenly, U.S. fighter planes from the carrier Saratoga engaged and shot down four Russian fighters over the Gulf of Sidra. The Russians responded, destroying a U.S. supply ship in the Indian Ocean. The U.S. struck back at two Soviet cruisers in the North Atlantic, sinking one of them. Soviet Bloc troops invaded Western Europe and within 24 hours, the badly outnumbered U.S. troops coordinated tactical nuclear strikes to stop Russian tank assaults in the Fulda Gap. The Warsaw Pact launched a limited first strike on key U.S. military installations and silos in the Mid West. America responded with an attack of 350 warheads of their own and nuclear war commenced.

The USA's Strategic Defense Initiative (SDI) shot down 65% of incoming Russian missiles and the Russian particle beam weapon shot down almost 30% of incoming U.S. missiles. The nuclear weapons detonations generated a powerful electromagnetic pulse that knocked out electronic devices. The EMP effect prevented a second strike by either country and a mere two billion humans perished!

**FAVORITE ITEM:** Money!!!!

**DRESS:** Like Gen-Humans, most Humans wear fashionable skin suits.

**HANGOUT:** Earth. For some strange reason, unknown to the Gen-Humans, Humans want to revisit the planet Earth.

**ABODE:** "Four bedroom, two bathroom, split level ranch house, yuppy vehicle in the driveway. 2.3 kids, a twelve slice toaster oven, Tri-V, don't have an indoor holo-room but we are thinking about getting one next year."

**COMBAT TACTICS:** Modern Humans can be notoriously nasty, much like their ancestors. Humans claim to be direct or indirect descendants of an ancient Earth culture known as Americans who were known to be some of the dirtiest fighters around. These people were known to use any means not to get themselves killed.

**GENERAL OCCUPATION:** Humans can take up any occupation. Most Galactic military vehicles are designed to be piloted by Humans and they gain new levels of piloting skill at 1 point less than normal cost. This applies to tanks, fighters, and all other types of military and non military vehicles.

**VIEW ON LIFE:** It is a struggle of unprecedented proportions. The ultimate goal is to achieve happiness.

**WAR:** This is the greatest of all evils. Let none forget the past or they will be condemned to repeat it. It is the audacity of our brethren, the Gen-Humans to believe in this. We must dissuade them from such folly.

**ALLIANCE:** The Wheel of Corruption turns. It is large. I am small.

**UNIVERSE:** A marvel to behold. A vast garden, stretching to the outskirts of infinity. We have only sown a few seeds there. Our destiny is out beyond the farthest light.

**FAMILY:** It is very important overall.

**SELF:** I think, therefore I am! I think.

#### NOTABLE HUMAN STATEMENTS

Where are my d10s?

Hey! Let's get some chicken wings! I want 50 "suicidal."

The Bills are great!

## MAZIAN

MOTS-ee-en

#### VITAL STATISTICS

- 20 Strength
- +15 I.Q.
- 30 Agility
- 25 Constitution
- 15 Aggression
- 05 Intuition
- 10 Charisma

#### SECONDARY STATISTICS

- 10 Terrestrial Knowledge
- 20 Military Leadership
- 10 Persuasion





**SPECIAL ABILITIES**

- Shape change
- Immune to neuro-toxins
- Vibration sense
- 3rd level climbing skill
- Highly resistant to biological attacks
- Half damage from concussion attacks
- Swim at 5th level proficiency
- Sonar

**LIABILITIES**

- Sensitive to electricity
- Sensitive to sonic attacks
- Sensitive to radiation
- Blind

**GENERAL OCCUPATION**

- Espionage

**GENERAL KNOWLEDGE:** This amphibious being is an anomaly in the evolutionary process. The Mazian is a xenomorph, able to shape change so as to resemble other objects. Hence the nickname 'Changeling.' It is normally a gel-like amorphous being, each cell existing as a separate entity and yet working in a harmonious symbiotic relation with the other cells around it.

The Mazian has no central nervous system, rather the outer layer of skin is composed of a neuro-mesh network. This neuro-mesh is very sensitive and the Changeling's node covered body allows the Mazian to sense ground vibrations out to 100m. The nodes are also extremely sensitive to sonic vibrations. Thus, sonic based attacks are deadly against the jelly balls (double damage).

The blob has no internal organs, except a central ganglion mass which scientists have proven to be some kind of brain. It is an asexual being that reproduces every 10 years. It eats by absorbing liquids into its body and the Mazian can absorb small objects (hand grenades included) for temporary storage. Changelings cannot see, but have evolved a complex form of sonar which allows them to distinguish shapes out to 250m. They have a fantastic sense of smell, able to detect residual odors better than a bloodhound. Their sense of taste is so good that they can use it to distinguish colors. Mazians also have limited light sensitivity that extends out to 5cm, this allows them to "read".

The Changeling's ability to change its form makes it the ultimate espionage/infiltration specialist. However, this ability is somewhat limited. The Changeling can never replicate into something greater than twice its size or five times its weight. It can never replicate anything greater than a size class 5 individual, no matter what. The Mazian begins the game with a 60 percent chance of mimicking the most simple shapes, such as rocks. Replicating a rock is considered a level 1 skill task while replicating a Human is considered a level 15 task. (SEE OCCUPATIONAL SKILLS). As the Mazian learns to control the cell metamorphoses, its chance to accurately duplicate something increases. At high levels, a Mazian can replicate a humanoid form.

When attempting to replicate, the Changeling flows over an object, internally records the physical matrix, then copies it. Mazians often pay handsome amounts of money for Internal Flex Networks (IFN) to aid them in replicating. IFNs are flexible joint structures that can be manipulated into basic skeletal outlines. The Changeling uses the skeleton structure to enhance its ability to duplicate complicated shapes such as living creatures. The IFNs increase the base chance of replication by 20%, and allow the Mazian to support its body vertically.

Mazian PCs begin the game with a voice emitter, allowing them to communicate normally.

**GOVERNMENT:** "What government?" If we need to do something, we all get together and do it.

**CULTURE:** Mazians are very social beings and are often found stacked on top of each other, ten to twenty deep. The Changelings like the idea of being close and have no problem with "space." The Mazian hierarchy exists in that the biggest get to shove the smaller guys around. But why would anyone want to do that anyway?

**PHYSIOLOGICAL MAKEUP:** The blob typically communicates by making deep grunting sounds which carry well through water. When on land, the Changeling sends coded messages by thumping itself against the ground. It can send these messages up to 800m to another of its kind. Pythons are the only other race that has been able to decode ground transmitted messages. Naturally this is rare, since Pythons aren't known for being "brilliant." To communicate with other races, the Mazian uses a vocal synthesizer.

A full 15% of all Changelings are born with a chameleon ability. Chameleon Mazians begin the game with 3rd level in camouflage skill. Life Expectancy: 50 years.

**WEAKNESS:** The most predominant weakness of Mazians besides sonic attacks is radiation. High doses of radiation burn the blob, doing 2-8 points of damage to any Mazian who fails to make an SMR vs Radiation and 1-4 points if a successful SMR is made.

**QUIRKS:** These guys are the definition of quirk.

**HISTORY:** Mazians are a very intelligent race, yet never managed to develop space travel because they have no means to manipulate heavy objects and they have no sight. They were first discovered by the Cizerack in 1011 BC. Strangely enough, the two races developed friendly relations.

**FAVORITE ITEM:** Mazians have no favorite item per se. They enjoy anything that happens to be inside them at the time.

**HANGOUT:** Mazians prefer to hang out in mud puddles.

**DRESS:** Mazians don't wear anything at all.

**ABODE:** The same mud puddle.

**COMBAT TACTICS:** Mazians don't want to get into combat at all. If they have to, they often crawl around in the grass, strategically dropping off little goodies, such as mines which they can hold inside their bodies while moving.

**GENERAL OCCUPATION:** Changelings are usually hired as espionage agents due to their uncanny skill at infiltrating enemy positions. They dislike Chatilians because of the empath's natural ability to locate them. Furthermore, Chatilians utilize sonic based attacks which can be deadly to a Changeling.

**VIEW ON LIFE:** I ooze through it with great comfort, examining the external makeup of everything. "Some guys get over. Me, I slide."

**WAR:** It is nonsense. Each side tries to ooze over the other in an effort to win a piece of land which we could all enjoy.

**ALLIANCE:** Useless. What reason is there for anyone to want to control another.

**UNIVERSE:** A fantastic object of unimaginable proportions. It's too big for me to fathom, though I would ultimately like to ooze over every inch of it.



## Character Races

**FAMILY:** My biological offspring? I haven't bumped into one of them in a while.

**SELF:** My construction is perfect for discovering the true nature of things.

### NOTABLE MAZIAN STATEMENTS

Where the Hell am I?

Oooh! This feels great!

I'm the psychedelic dirtball!

## MUTZACHAN

Moot-ZAH-kin

### VITAL STATISTICS

- 15 Strength
- +30 I.Q.
- +05 Manual Dexterity
- 15 Constitution
- +15 Intuition
- +10 Charisma

### SECONDARY STATISTICS

- +10 Terrestrial Knowledge
- 05 Military Leadership
- +05 Bargaining

### SPECIAL ABILITIES

- Matrix control
- Resistant to the effects of radiation
- Gain engineering skills at 1/2 cost

### LIABILITIES

- Susceptible to disease

### GENERAL OCCUPATION

- Matrix Controller
- Ionization Engineer

**GENERAL KNOWLEDGE:** The Mutzachan (Energy Controller) is probably the most powerful of all the known races. They have the innate ability to manipulate energy forms and can use these forms to generate tremendous amounts of power. Mutzachans with high intelligence scores earn bonuses when "generating." Energy Controllers can not properly generate while wearing body armor for it disrupts the harnessing process. The cost to generate when wearing armor is doubled. This does not include helmets. These "melon heads," as Humans call them, love energy in its raw, uncorrupted form. They view the storage of energy as useless. Thus, Mutzachans must purchase specially insulated energy based weapons which cost fifty percent above the retail cost. Otherwise, they would suck the energy dry to get a "rush."

Mutzachans are indigenous to the planet Trishmag of the Cygni-A star system. They are small, bipedal humanoids, with large heads and large pale green eyes. The energy controllers are by far the most intellectually advanced race in the known galaxies. Their brains have almost twice the convoluted surface area of human brains. However, they pay for this with an inherently weak physiological makeup which is extremely susceptible to disease and infection. The entire Mutzachan population is less than 400 million and their culture has almost been eradicated twice, due to plague.

Melon Heads have a very low fertility rate, with the females bearing young only once every 100 years. The average life expectancy for a Mutzachan is about 2000 years.

Female Mutzachans have a 30% chance for an extra power point.

**GOVERNMENT:** The Mutzachan people are ruled by an oligarchy called the Vision of Eight. This body used to be known as the Council of Timar. However when the Alliance was formed, its governing body was named the Council of Timar, and the eight member body changed its name to avoid confusion. Note that the Vision of Eight are also the Mutzachan representatives to the Council of Timar. The Mutzachans have established a peaceful unity among themselves and the people haven't fought an internal war in some 200,000 years. Most Mutzachan societies are communal.

**CULTURE:** This culture emphasizes knowledge above all else. Children attend public schools for 150 years, until they have reached adolescence. Upon reaching the age of consent, the Mutzachan finds a Mentor to teach him for the next 100 years or so.

Energy Controllers are generally law abiding. Some view adventuring as a boring pastime that is only engaged in by the unenlightened.

**PHYSIOLOGICAL MAKEUP:** Energy Controllers engage in a strange ritual of cleansing the body every month. They go into isolation and purge themselves by draining most of their blood, which is clear.

**WEAKNESS:** Mutzachans can be killed by the radioactive isotope Korilium 312. Korilium emits deadly gamma-2 rays which can kill an energy controller in short order. Mutzachans must make an SMR vs radiation at a -70 or die within 10-40 minutes if exposed to Korilium. This isotope is rare, but can be found on the Black Market. Possession of Korilium carries the Death Penalty. It costs 25,000cr per dose.

**QUIRKS:** Melon Heads like to keep pet rocks, usually a hunk of Uranium 235 or something "neat" like that. These inquisitive beings are always trying to solve unanswerable questions like, "What is the origin of everything?" Energy controllers are forever trying to hold "deep" conversations and often drive others away, those who don't have the foggiest idea of what the Mutzachan is babbling about.

Mutzachans love to head butt others just for the fun of it. The Mutzachan head butt does temporary damage (1-3 points). It is stylish to wear a head band if you are a Mutzachan head butt kind of guy.

**HISTORY:** Recorded history predates 400,000 BC. Chronologies, kept in the Mutzachan libraries, suggest that they first developed space travel around 110,000 BC. Trishmag's surface contains abnormally high levels of the radioactive elements Uranium 235, Rutilium, Plutonium 255, and Tritium 305, and Korilium. Hence, Mutzachans have developed an immunity to all but the highest levels of radiation and can actually feed off radiation to speed up the recovery time necessary to "generate". A Mutzachan's idea of sunbathing is lying out where the radioactive decay emissions are about 200 rads / hour. (2 rads/hour is considered safe for humans).

Darwin's theory of the survival of the fittest applies to all aspects of life on Trishmag. In order to survive, the Mutzachans have had to learn to overcome the planet's natural instabilities by learning to manipulate energy structures. All children are required to attend school year-round in order to learn the controlling matrices, and do so quite willingly. The best students attend the Cotarzhadin, dreaming of one day being taught the most powerful of energy matrices, Mutzia-cieve (time travel).

Energy Controllers share a friendly relationship with Humans, having first made contact with them before the birth of Christ. It was the Mutzachans who helped the Egyptians to build the pyramids. In 2055 they made contact again, offering technical knowledge necessary to build starships in exchange for medicines and medical knowledge. The friendship prospered and in 2091, the Mutzachans helped Humans build the first stargate.



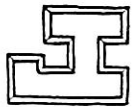
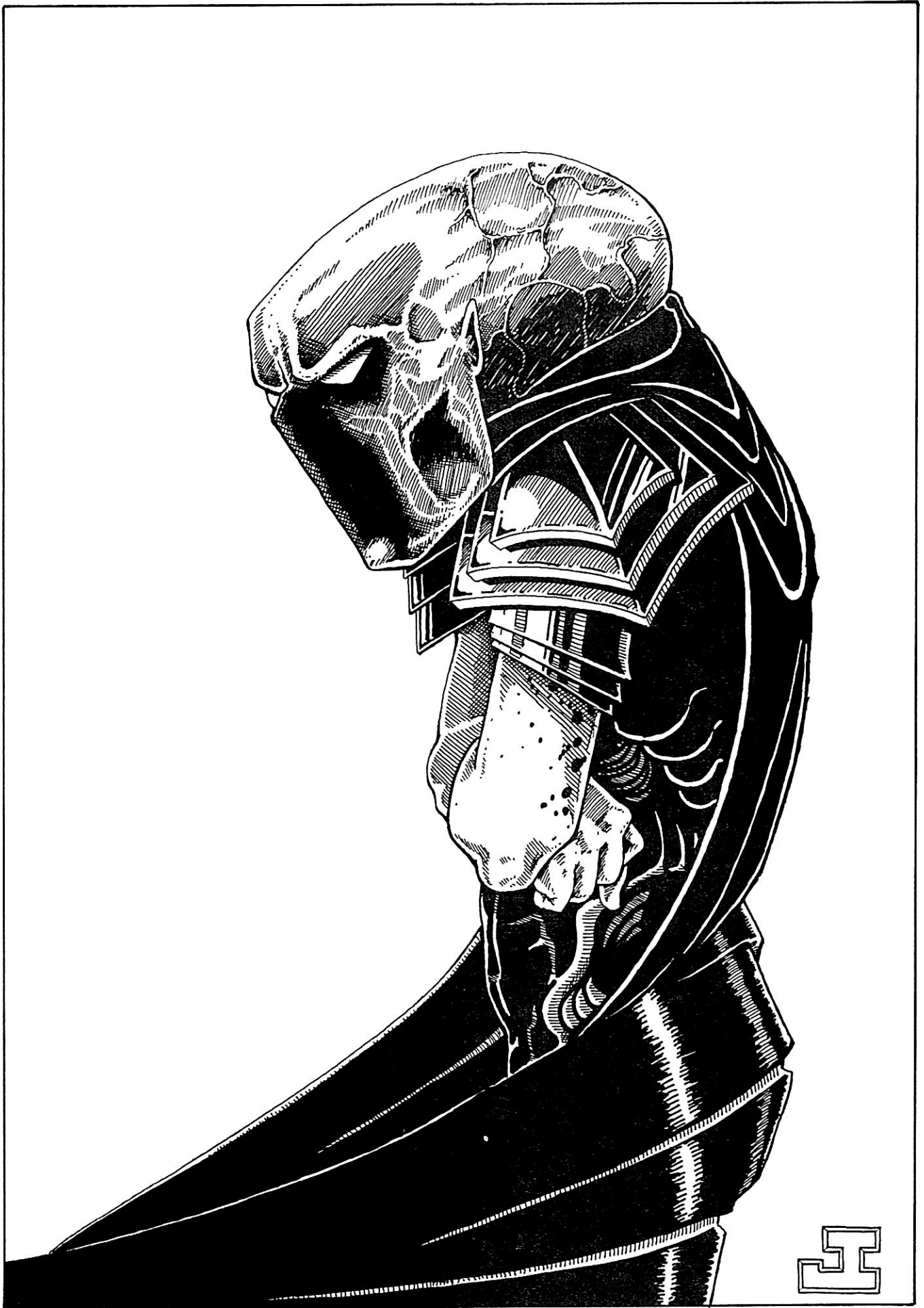

**FAVORITE ITEM:** As noted before, energy controllers love anything radioactive. Most Mutzachans would love to have a built-in reactor in their dining room, but this is considered somewhat impractical unless one is affluent.

**DRESS:** Mutzachans wear thin, translucent clothing called Gia under their robes. The average length of a Mutzachan robe is 5m and the robe drags along behind the energy controller. Mutzachans become very offended when others step on their train (the section of the robe that drags along the floor).

**HANGOUT:** Just go to the local power authority if you are looking for energy controllers. Mutzachans like to just hang out outside of a nuclear or fusion substation and dream of what it must be like inside the core, to be covered in the pulsing warmth of the "blue light." Of course energy controllers can't survive being exposed to such a massive radiation exposure, but they are free to dream about it!

**ABODE:** These beings live in great edifices made of glass and steel. These palaces are the rave of conversation everywhere, engineering masterpieces. A typical Mutzachan home has 5 floors and 25 rooms. Mutzachan architecture advocates the change of room dimensions and geometric shape. Some rooms are round while others are triangular or square.

**COMBAT TACTICS:** Most matrix controllers don't prefer combat. However, when thoughtfully employed, Mutzachan powers are deadly.

**GENERAL OCCUPATION:** Most Mutzachans are hired as crew on board starships to work the complex ion drive engines. They learn engineering skills at 1/2 the normal point cost, due to their natural co-existence with energy and radiation. Others find jobs at spaceports and a few bold Mutzachans get hired out for combat as matrix controllers.

**VIEW ON LIFE:** It is an ongoing process, balanced and exact. My purpose is to investigate the opportunity to gain knowledge through this medium.

**WAR:** It balances out the nature of things.

**ALLIANCE:** By the constructs of its fundamental being, it serves to balance out competing forces in a most harmonious fashion.

**UNIVERSE:** The entity which I ultimately serve. Its grandeur encompasses everything.

**FAMILY:** Merely a social form.

**SELF:** Only through enlightenment can I become great in stature.

#### NOTABLE MUTZACHAN STATEMENTS

Einstein had no idea of what he was talking about. The truth is.... Do I really talk that much?  
I resent being called a Melon Head.

## ORION ROGUE

O-Rye-un Ro-g

### VITAL STATISTICS

+20 Manual Dexterity  
+05 Agility  
+20 Intuition  
+20 Charisma

### SECONDARY STATISTICS

+25 Terrestrial Knowledge  
+15 Persuasion  
+20 Bargaining

### SPECIAL ABILITIES

60 proficiency slots  
3rd level proficiency in street smart  
1st level proficiency in stealth  
1st level proficiency in pick pockets  
Sneaking

### LIABILITIES

None

### GENERAL OCCUPATION

Thief

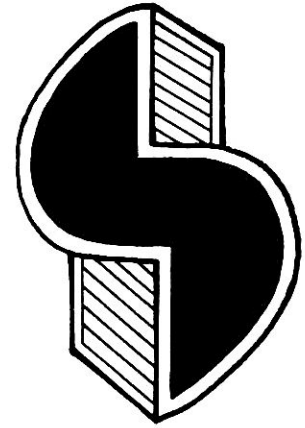

**GENERAL KNOWLEDGE:** The Orion Rogue is the "trouble child" of the Galactic Alliance. This happy go lucky menace can always find a quick way to get himself into trouble. He is terribly curious, interminably devious, and forever mischievous. Orion Rogues look exactly like Humans, except that the Rogues have seven fingers on each hand and possess pointed ears. All Orion characters begin the game with 60 proficiency points as opposed to the normal 50.

Rogues tend to hang out in the seedier parts of town, looking for adventure and begin the game with 3rd level proficiency in street smarts. Rogues are eternal hedonists, appreciating the fleeting nature of life. Orions also like to test the limits of the extent and type of materials to be consumed.

Orions party more than all other races combined. They love nothing better than to sneak on board an outgoing starliner and go some place to party for a while. Orions have a base 70% chance to successfully sneak on board any spaceship and they take great pride in their "sneakery", teaching each new generation the art of sneaking. There are mandatory classes where kids go and learn how to "sneak."

Though they may act like a clowns, Orions are actually quite cunning. People love their company and Rogues are quite good at striking bargains with the "sucker" who is eating up everything that he says. Orions are persuasive and gain bonuses when attempting to persuade and barter. Since Orions are forever sneaking, they travel all over the galaxy and gain a +25 modifier to terrestrial knowledge scores.

**GOVERNMENT:** The Orion government is a syndicracy. Each member on the Economic Council represents some planetary business interest. The Economic Council is loved by the people because business is thriving and Taos is the "hub" of galactic trade. The powerful businesses moguls retain the support of the people by levying no taxes and providing free public housing, school, and medical care for everyone.

**CULTURE:** This culture is the quintessential "melting pot." Every race, species, and subspecies can be found somewhere on Taos. The people are friendly, inquisitive, and greatly enjoy the presence of foreigners. The people of Taos are free to do whatever they choose,



as long as it doesn't infringe on the rights of others. However, traveling Eridani are severely restricted, a problem that continually fuels the enmity between the Rogues and Swordsaints.

**PHYSIOLOGICAL MAKEUP:** Rogues reproduce in the same manner as Humans and Gen-Humans. They do have small, pointed ears. Humans and Gen-Humans find this trait appealing.

**WEAKNESS:** Orions become "Spot Junkies" very easily. The Rogue must avoid the temptation to "DO" the deadly hallucinogenic drug Blue Cocaine. This Cocaine derivative, when taken by Orions, causes powerful hallucinations which last for 1-4 days. While drugged, the Orion is completely disorientated and very susceptible to manic depression. He has a 05% base chance to kill himself outright and a 60% chance to do himself bodily harm. Many Orions yearn to try the drug once, curious to see if it is as good as others say it is. Prudent Orions avoid Blue Cocaine at all costs.

**QUIRKS:** Orions are notorious smokers, legal or illegal, often taking time out to light up in the heat of battle. Non-smokers are a rarity on Taos and the big gripe that vacationers have when they come to Taos is that there is always a cloud of smoke lingering in the air.

Orions tend to view danger with a tinge of humor. If you are going to die, then it will certainly be eventful. So why fear it? It does you no good. Consequently, there is a 10% chance for an Orion to laugh in any dangerous situation.

**HISTORY:** Many archaeologists speculate that the Rogue is a direct descendant of the Atlantians. Others refute this, arguing that there is no record of any migration and the Orions didn't develop space travel until 2403 B.C. How they came to evolve 7 fingers per hand and pointed ears is also a mystery.

The Rogues first developed space travel with the unlikely aid of the Phentari. Both peoples faced invasion by the hostile Eridani forces. With the assistance of the Phentari, the Orions built intra-galactic spacecraft, then spread their people out across the emptiness of space in order to ensure the race's survival. The Orions and the Phentari signed the Kwashime Alliance in 1770 B.C., then mounted an all out offensive and defeated the Eridani at the Battle of the Three Powers over Eridine. The two unlikely allies are still close and have open trade routes.

**FAVORITE ITEM:** Their favorite item is anything that once belong to you that is now in the Rogues pocket. He thanks you for your supreme generosity.

**HANGOUT:** Orions prefer to hang out in bars. The most popular Orion Bar is Mogs, a seedy and dangerous establishment on Taos 4.

**DRESS:** Orions commonly wear a kilt-like skirt called a Bwal. The family colors are embroidered on the Bwal and are a sign of social class. The Orions were quite pleased to find out that an ancient Earth culture called Scots wore Bwal-like apparel. Since this discovery, many Orions have adapted the musical instrument called bagpipes which was common to this ancient culture. If you ask an Orion who he is, he may very well tell you that he is a Scotsman from Taos 4 and offer to play you a tune on his bagpipe. Cost: 2000cr.

**ABODE:** Their homes are filled with junk, forever cluttered with stuff that every other person would find totally useless. Orions also love maps and the walls of their houses are covered with them. It must be stated that the lounging room where the Orion keeps his pipe and beverages is kept immaculate. Naturally, every Rogue male has his own favorite chair!

**COMBAT TACTICS:** The Orions favorite combat tactic is the one that produces the most wonderfully and startling results for the moment. Consequently, many Rogues love explosives and grenades which produce lots of noise when they are detonated.

**GENERAL OCCUPATION:** The seven fingers per hand is the great asset to Orions. This blessing gives them bonuses to manual dexterity checks. They are sometimes hired as factory workers in assembly plants, where they are paid an average of 20% more than their fellow workers. Most Orions are bored with the concept of manual labor and the often child-like race prefers the danger and excitement of space to the drab confines of planet bound factories.

The Rogue will catch a 'hop' just for kicks. Why work when one can reap the liberties of somebody's unzipped pocket? All Orions begin the game with 1st level proficiency in stealth and pick pockets. Normally, this is how they make their living.

**VIEW ON LIFE:** What a great adventure. Don't take it too seriously though. It is fleeting. Just enjoy and party!!!

**WAR:** I think planets should party together more often. If you have got a problem, you party with each other until you solve it or until no one cares anymore.

Hey Dude. I heard that the planet Crossroads is having 10,000 kegs next month in celebration of defeating the Arachnids. Want to go?

**ALLIANCE:** I question the need for such a bureaucratic body. Hey Dude! Lets party!

**UNIVERSE:** Its one massive blow out!

**FAMILY:** My brothers are pretty lame. They never make last call.

**SELF:** I have only begun to unravel the mystery. The answer will undoubtedly be deathly cool!

#### NOTABLE ORION STATEMENTS

I double dare you!!

Man! Am I hung over.

I wonder what will happen if I push this button?

## PHENTARI

Fen-TAR-ee

#### VITAL STATISTICS

-05 Strength  
 +12 I.Q.  
 +25 Manual Dexterity  
 +05 Agility  
 -05 Constitution  
 +20 Aggression  
 +05 Intuition  
 -35 Charisma

#### SECONDARY STATISTICS

+15 Terrestrial Knowledge  
 +10 Military Leadership  
 -20 Persuasion

#### SPECIAL ABILITIES

Fires multiple weapons  
 1st level proficiency in climbing  
 Immune to the effects of methane  
 Regeneration of lost arms



**LIABILITIES**

Must wear atmospheric processor

**GENERAL OCCUPATION**

Bounty Hunter

**GENERAL KNOWLEDGE:** The Phentari race is the most mistrusted, disliked, and feared of all the known races. They are bipedal squid-like beings with generally nasty dispositions toward life and are sometimes called names like Grim Reaper, Cold Death, Demon Spawn, and Soul Sucker.

Phentari are indigenous to the methane planet Phena in the Tau Ceti star system. They are typically evil, but a few have been known to be good. Phentari have four sinuous arms, each of which is capable of independent action. This allows the squid to target and fire multiple weapons, or perform multiple independent actions simultaneously. A Phentari can attack no more than two different targets in any given instant though. He may use more than one tentacle to engage them. When using edged weapons, the squid attacks like a mobile cuisinarte. Each tentacle has a maximum encumbrance strength of 6 points. Any item that has an encumbrance value of greater than 6, must be carried with 2 or more tentacles. Multiple tentacles also allow the squid to climb quite well. Thus, all Phentari begin the game with one level of proficiency in climbing. Phentari possess stump like legs which offer little balance. They have long since adopted prosthetic gear to facilitate running.

Phena has a 20% methane atmosphere and like the Eridani, the Phentari must wear an atmospheric processor when operating outside of a methane environment. They are not liked by most other races who view them as evil and treacherous. This suits the Phentari just fine for he holds all weaker beings in utter contempt anyway. Many Phentari follow the philosophy that "All fear me!!! Those who don't, I have already disposed of!" The squids understand their own version of persuasion which is coercion. Why would there be any other method of getting someone to do something for you? The only races that the Phentari actually like are Orions and Tza Zen Rigeln. Phentari do respect those who are powerful, but they deplore cowardice.

**GOVERNMENT:** The Phentari people are ruled by a militocracy. Phena boasts a huge army that is prepared to go to war at a moments notice. The government has sworn that it will never be ambushed by the treacherous likes of the Eridani. It rules with an iron fist and thus there is some strife among Phena's people. There exist two factions of the military, the ruling Darmine government, and the Solmal. The Solmal claim that they can improve the living conditions of the peoples and have gained some support from the masses.

**CULTURE:** Phentari culture advocates superiority. Somehow, after fifteen civil wars the people have avoided any further conflict among themselves. They prefer to subjugate others to their will. The most powerful and cunning Phentari are exalted and all children worship the great Jaquassarius Phentari, the most notorious fugitive in the galaxies (SEE RACE PICTORIAL). Heroes (most others consider them villains) are the icons of Phentari society.

**PHYSIOLOGICAL MAKEUP:** The squids have raspy voices that hiss when they speak and Phentari make a noise like the sound of the wind when they breathe. The female squids reproduces every 4 years. After mating, the male must escape with his life. Those who fail are killed by the female for their lack of cunning. The test proves the resourceful nature of the Phentari male. The male and female must agree on terms for the ritual before mating and though they seldom openly admit it, most male squids fear their wives.

Squids live to be 150 years old.

There is only a 10% base chance to surprise a squid, due to their fish eyes. A Phentari will fully regenerate a lost "arm" in 1 month.

**WEAKNESS:** Bounty Hunters are susceptible to mercuric poisoning like Eridani. The difference is that Phentari love to use mercury on their victims.

**QUIRKS:** If there is one quirk that stands out the most about Phentari is that they see no problem of offering to help "granny" across the street, just so they can kill her when she gets to the other side.

It might not seem like a quirk, but Phentari prefer the taste of Human above all other dishes. These carnivorous squids pride themselves on being excellent chefs and have found hundreds of ways to serve up their favorite meal.

**HISTORY:** Phentari history is strange. They first developed interplanetary travel in 4227 BC. This industrious race set forth to develop intra-galactic travel and in 4012 made a break through on translight technology. Within decades, Phentari vessels swept out across the galaxy and in 3431 B.C., while exploring the uncharted Piscium star system, the Phentari exploration vessels were ambushed by Eridani warships and destroyed. The smooth running Eridani military juggernaut quickly hunted down the Phentari colony planets and slaughtered their peoples.

Désperate, the Phentari sought the aid of the Orions who they had only heard of through intelligence reports. (Actually, the Orions were to be the next Phentari victims. But that fact matters little now). The two fate sealed allies quickly acted to defeat the Eridani with the legendary Phisicus Phentari leading the naval assault on Eridine.

**FAVORITE ITEM:** Phentari love to collect skulls, mounting them above the mantle in their homes. Any Phentari worth his spit has a couple of dozen.

**DRESS:** Squids love to wear the color red on their flashy black cape which is called a Dward. Many Phentari brandish the number of kills in the form of hash marks embroidered on the sleeve of the cape.

**HANGOUT:** Bounty Hunters take time off from work to visit cemeteries, military museums, and old battlefields.

**ABODE:** Phentari take much pride in their homes which are always kept spotless. Squids enjoy fireplace equivalents (safeguarded from explosion) and keep trophy skulls on the mantel piece above it. Many Phentari dabble in chemistry, loving to concoct new poisons and the wealthy have chem labs built into their abodes.

**COMBAT TACTICS:** Phentari Bounty Hunters employ any tactic that is adequate to get the job done.

**GENERAL OCCUPATION:** Some squids are normally found working for Galactic Death Squads; however, most Phentari prefer more respectable jobs such as Bounty Hunting. Phentari approach this job with the zeal of a child. "Killing is great sport, especially if you're getting paid for it".

**VIEW ON LIFE:** It exists as a forum for my natural superiority over the weak and pathetic.

**WAR:** The triumphant example of spirit. The process of natural selection where only the strong survive.

**ALLIANCE:** To be vanquished along with the weak peddlers of its faith. But not now. The time isn't right. One day the universe shall be the bastion of Phentari might.





**UNIVERSE:** To be conquered.

**FAMILY:** It serves absolutely no definitive purpose. It merely is what it is.

**SELF:** I am the supreme being.

#### NOTABLE PHENTARI STATEMENTS

I'd like the Super Deluxe Human Combo with a side order of french fry equivalents.

You're under arrest butthead. What for? I don't know. Don't worry, I'll think of something.

I am going to torture you until you expire. Your screams shall invigorate me. Time to die, you pathetic excuse for a lifeform...

## PYTHON LIZARD

Pi-Thon LIZ-erd

#### VITAL STATISTICS

+30	Strength
-10	I.Q.
-25	Manual Dexterity
-05	Agility
+30	Constitution
+30	Aggression
-10	Intuition
-30	Charisma

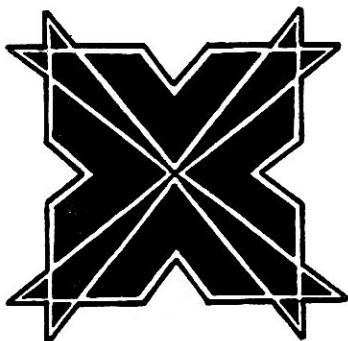

#### SECONDARY STATISTICS

+15	Military Leadership
-05	Persuasion
-20	Terrestrial Knowledge

#### SPECIAL ABILITIES

Two point body threshold  
6th level proficiency in swimming  
Infravision  
Vibration Sense

#### LIABILITIES

Sensitive to dry environments  
Extreme cold causes hibernation

#### GENERAL OCCUPATION

Combat Technician  
Galactic Police

**GENERAL KNOWLEDGE:** The Pythons are a huge powerful race of lizards, indigenous to the planets Pythos and Ashira of the Floridian star system. These great reptiles are the backbone of amphibious assault units in the Galactic Marines, proud and defiant warriors whose lifelong ambitions are to fight the ultimate battle. The Python is a veritable fighting machine. Unarmed, it attacks with both claws, a vicious bite, and its long prehensile tail all in the same hand to hand melee segment. The claw attacks do 1-2 points of damage, the powerful jaws deal out 1-4 points, and the tail strikes for 1-3 points, though the tail cannot strike to the front. They have a thick, scaly hide that provides them with a natural 2 point threshold against most attacks. These prehistoric dinosaurs are overtly aggressive and those Pythons with high aggression scores are capable of fighting into the negative body points. The vast majority of Pythons follow a strict code of honor and adamantly adhere to the precepts of law and order. They gain a 10% bonus modifier to loyalty scores.

Pythons are aquatic beings, dwelling in the great swamp-like inland seas that cover much of the surface of their home planet. They

don't hear sounds as humans do, but rather sense vibrations through their skin. Their sensory range reaches out to 100m. All Pythons Lizards swim at 6th level of proficiency and can reach a maximum speed of 50kph for short durations. The lizards can dive to depths of 200m and are capable of holding their breath for up to 10 minutes. The drawback is that Python Lizards are sensitive to dry environments and susceptible to cold. When the temperature drops below zero degrees celsius, Pythons usually crawl in some comfortable place and catch some ZZZs.

The lizards are generally less intelligent than their galactic counterparts. They are penalized 10 points on intelligence scores, but don't view this as a handicap. They generally accept their position as the preferred warrior race of the Gen-Humans. Now don't get me wrong! Python Lizards are much smarter than Ram Pythons, not that this is saying much. They have excellent leadership skills and gain an additional +15 modifier to all military leadership scores.

**GOVERNMENT:** Pythons are some of the most territorial beings in the galaxy. The governmental infra-structure is clan-like, with the strongest clans controlling the most territory. The water boundaries are continuously contested and clans often invade fertile turf to gain new feeding grounds. However, the Python peoples drop their internal problems in order to fight the Ram Pythons who from time to time invade lizard waters in order to kill a few of the lizards.

**CULTURE:** The strongest males control the society. The great Python lords can dive to a depth of 200m, or do battle with the Cantuch (shark). Such deeds are held in high regard and are the topic of conversation.

Females are respected, and a pregnant mother is staunchly protected by her people.

**PHYSIOLOGICAL MAKEUP:** The Python Lizard is generally an aquatic reptile. It can, however, exist out of water for extended periods of time.

The females of the species have reddish/brown colored hides and lay their eggs once a year. They lay some 200 eggs at a time and remain with them only for the first twenty days of the fifty day incubation period.

**WEAKNESS:** Python Lizards cringe when anyone mentions the substance known as Blood Salt. Blood Salt is a powdery desiccant that sucks the moisture out of objects. It does 2-8 points of damage to Pythons per sprinkle. Blood Salt dries so that it leaves painful lesions in the skin which heal very slowly, reducing Agility by 2-12 points. The effects can be corrected over time with the application of skin moisturizers. Blood Salt costs 1000cr for 6 doses.

**QUIRKS:** Pythons enjoy Ancient Earth style Heavy Metal music.

**HISTORY:** Their history is characterized by war. The Pythons share their planet with their brethren, the Ram Python. The Ram is predominately a land lizard. The two races have fought three civil wars to determine racial superiority. The Python lizards have only won one of them. The Ram is just too strong.

Both races despise the Cizerack who invaded their planet. Pythons find the cat quick tongued and deceitful. In 1856 A.D, the first Cizerack ships landed on the planet and attempted to coerce the Pythons into submission through trickery and deceit. The Pythons were wise to their machinations and terminated the Cizerack emissary at Makel. The wicked Cizerack then declared war and invaded the planet Pythos. Without adequate weapons and technology, the Pythons were faced with dishonorable surrender or complete annihilation. They surrendered.

The occupation of the Python homeland lasted for 85 years until Narsh of Makel led the Python people in open revolt during 1941 A.D. Eventually, the Cizerack withdrew, realizing the undaunted courage of the Python nation. In 2104, the Gen-Humans visited the planet Pythos. Wisdom prevailed and the Pythons were not tricked



into submission. After much dealing with the visitors, the Pythons sought out an alliance and took the celebrated job of mercenaries for these strange little creatures from space.

**FAVORITE ITEM:** Fishing Poles. Python Lizards love the sport of fishing and carry a pole with them every where they go. Most Pythons think that this Human form of entertainment is great fun, although slightly stupid.

**DRESS:** When out of water, Pythons wear a water secreting skin suit called a Nub. The suit helps to keep the lizard's skin moist.

**HANGOUT:** Pythons typically hangout near their feeding grounds.

**ABODE:** The home is an underwater cave, preferably one with stalactites and stalagmites. The caves must be spacious and have multiple entrances. Pythons adorn the walls with pieces of coral and semi-precious metals. They often grow gardens of kelp near the cave entrance to their homes.

**COMBAT TACTICS:** Lizards fight honorably, though with intense fervor. They love flamethrowers for some peculiar reason.

**GENERAL OCCUPATION:** The Pythons are military warriors and are utilized as shock troops in the Galactic Marines, stormtroopers, the GRF, and Galactic Police where they exhibit unswerving loyalty.

Many Pythons choose to buy waterproofed armor and weapons, at an additional cost of +10%. Environmentally contained armor is always waterproofed. The lizards pay twice the normal cost when taking piloting skill.

**VIEW ON LIFE:** The time to fight.

**WAR:** Beautiful.

**ALLIANCE:** It is our job to serve it.

**UNIVERSE:** I don't understand something that has no beginning or end. Since I can't see beyond 50m, it doesn't matter anyway.

**FAMILY:** My clan is great and powerful.

**SELF:** I am the warrior.

#### NOTABLE PYTHON STATEMENTS

I like Mackerel equivalent.  
Something smells fishy. Ha! Ha! Ha!  
I don't like you.

## RAM PYTHON

Ram PI-Thon

#### VITAL STATISTICS

+40 Strength  
-20 I.Q.  
-25 Manual Dexterity  
+15 Agility  
+30 Constitution  
+30 Aggression  
-15 Intuition  
-30 Charisma

#### SECONDARY STATISTICS

-20 Terrestrial Knowledge  
+20 Military Leadership  
-05 Persuasion



#### SPECIAL ABILITIES

2nd level camouflage  
3rd level stealth  
Infravision  
2nd level climbing  
Vibration sense  
Excellent smell

#### LIABILITIES

Limited sight (50m)

#### GENERAL OCCUPATION

Stormtrooper

**GENERAL KNOWLEDGE:** The Ram Python is the single largest intelligent creature in the Alliance. This massive dinosaur is similar to his cousin the Python Lizard and is indigenous to the same planets Pythos and Ashira of the Floridian star system. The primary difference between the two species is that the Ram Python lives on land and can not survive long periods in water. His skin coloration varies from a light gray to deep green-brown, depending on the season. This chameleon-like ability provides him with limited camouflage in forest, swamp, and jungle terrain. Player character Ram Pythons begin the game with the equivalent of 2nd level proficiency in camouflage and climbing.

The Ram is exceptionally agile for a being of its size and stalks creatures with 3rd level proficiency in stealth. He is also superior to the Python in strength, agility, and constitutional makeup. Now it is true that some Rams have an I.Q. two points above plant life and many couldn't spell the word 'cat' if you spotted them the C and A. But what does it matter? Warriors don't care about spelling. They wage battles. The Ram has limited eyesight, but incredible smell. This race also has the ability to sense heat sources, out to 100m.

**GOVERNMENT:** The Ram Python government is clan-like, each tribe controlling a piece of turf. The clans are forever battling each other for one purpose or another. Each clan is headed by the Tomud (chieftain) who is inevitably the toughest of all the Rams. Any Ram has the right to challenge the Tomud in battle. If the challenger wins, then he becomes the new Tomud. The chieftain is respected only as long as he is strong.

**CULTURE:** Courageous Rams are held in high esteem. Each great deed is told to the tribe at the Sanu (monthly meeting). The most triumphant Rams are given gifts to adorn themselves. They wear these trophies on their bodies as a sign of respect. Ram Pythons are greedy and love treasure, coveting silver, gold, and other shiny objects. Never get between a Ram and his treasure. Orion Rogues often use Aluminum foil when trading with Ram Pythons. "Hey man. Look at this beautiful trinket. I'll trade you your pulse cannon for it."

**PHYSIOLOGICAL MAKEUP:** The Ram has a crest on the back of his neck which becomes hot and glows faintly when he becomes enraged.

Like all Python races, Rams live to be around 200 years old. The males choose their mate in a strange ritual where the strongest females are allowed to mate with the chieftain and his 10 strongest warriors.

Ram Pythons have limited eyesight and can only see things clearly out to 50m. They generally accumulate their monies to purchase bionic eyes.

**WEAKNESS:** They have no other notable weakness other than those mentioned.



**QUIRKS:** Tree climbing is the great pastime of Rams everywhere. They often bet on who can climb the highest in a tree without falling.

Ram Pythons, like their cousins, are lovers of ancient earth music, particularly "Thrash Metal". Many Rams like the idea of walking into combat with the tunes cranked up. "It just sets the right mood for good combat!"

**HISTORY:** The Ram Python is generally chaotic in nature and thus does not get along very well with its counterpart, the Python. The two species have fought 3 civil wars over the last 5 millennia. Naturally, the Rams have won the last two. They enjoy beating up on the weaker aquatic lizards. The only thing better is trashing the demon cats.

Their entire history is just that, finding someone who is brave enough to do battle against them. Some of the greatest heroes in Alliance history have been Ram Pythons. The Legion of Honor is the highest award that can be bestowed on any individual. No race has been decorated with more of these medals than the Rams, 123 in all. Most of these have been awarded posthumously, but this matters little to the great lizard. To die amidst the rage of battle, is the greatest honor that can be bestowed upon anyone.

Neither Python race ever developed space travel. They had barely evolved above the Stone Age when the "evil" Cizerack intruded on the sanctity of the Pythons' "peaceful" way of life.

**FAVORITE ITEM:** Ram Pythons love Thwack'em Sticks, mood synthesizers, and walkmans. Of the three, the great lizard generally prefers the Thwack'em stick.

**DRESS:** Rams typically wear black skinsuits, adorned with their metals.

**HANGOUT:** Rams love to go to see the wrestling tournaments. These special preview events are expensive because all the lizards have to sit within 50m to watch the match. Wrestling tickets cost anywhere from 200-500cr apiece.

**ABODE:** Ram Pythons live in great tree houses. The houses are grouped in clumps, all houses in one group belonging to one clan. The prestige of the clan is denoted by how high the houses are above the ground. The highest houses belong to those of the highest social status. Finally, Rams move about the trees by swinging on huge vines called Eia.

**COMBAT TACTICS:** Run up to it and kill it. Another Ram favorite combat tactic is what has come to be known as the Death Knoogie. The Ram Python squeezes the head of his enemy until it squashes like a grape.

**GENERAL OCCUPATION:** Like the Python Lizards, the Ram Python often works for Galactic combat services where it can exercise its innate desire to kill things. Rams pay twice the normal cost when opting to take any piloting skill.

**VIEW ON LIFE:** I don't understand it.

**WAR:** If it moves, I kill it. If it doesn't move, I pick it up and kill it.

**ALLIANCE:** Is this something to eat?

**UNIVERSE:** No such word.

**FAMILY:** I like to wrestle with my brothers.

**SELF:** No such thing as Python Einstein. Leave me alone. I like to kill things. You got a problem with this?

## NOTABLE RAM PYTHON STATEMENTS

I did not mean to sit on the little Human.  
Mess with me. You get the Death Knoogie.  
Here Kitty, Kitty, Kitty. I got you little !@#!\$%

## ZEN RIGELN

Zen Rye-jel-n

## TZA ZEN RIGELN

Za Zen Rye-jel-n

### VITAL STATISTICS

-05 Strength  
+20 IQ  
-05 Agility  
+10 Constitution  
-25 Aggression (\* or +15)  
+05 Intuition  
+20 Charisma

### SECONDARY STATISTICS

-15 Terrestrial Knowledge  
-10 Military Leadership  
+10 Persuasion

### SPECIAL ABILITIES

Matrix Control  
3rd level in basic medical  
Medical skills cost 1 point less

### LIABILITIES

None

### GENERAL OCCUPATION

Medic-technician  
Doctor

**GENERAL KNOWLEDGE:** The Zen Rigeln are the much beloved race of the Galactic Alliance. They possess the power of healing and are much sought after as battle field medic-technicians and as domestic doctors. They hold life in the highest regard, abstaining from violence unless absolutely necessary. Most Zen are Abiders, although some are Rebels.

All Zen begin the game with 3rd level proficiency in basic medical treatment and they gain new levels of proficiency in any medical subskill at 1 point less than the normal cost (never less than 0.5). Through intense internal concentration, the Zen Rigeln is capable of harnessing psychic energy which he uses as a tool to heal injured individuals. The Zen places his hands on the injured area and begins to chant softly to himself, channeling a matrix of power. Generating can be very taxing to a Zen, depending on the matrix channeled. Often, he must rest for long periods of time afterward. A Healer is also capable of generating certain matrix types which enable him to determine the extent of injuries. At high levels of proficiency, the Zen can perform incredible feats such as brain surgery.

Because they are so loved, the Zen gain an automatic +20 bonus to charisma scores. Most commoners are willing to go out of their way to help a Zen in need. Zen are very visible, opting to always wear the colors of their current power level, typically a long ornate robe. Any Zen that doesn't wear his power color is automatically ostracized from society and labeled as a traitor. This does not necessarily mean that the Zen is a bad person, but only that he has broken the sanctity of Zen law and tradition. It is also illegal for ANY matrix controller not to wear his colors. Those individuals labeled traitor for any reason are called Tza Zen.

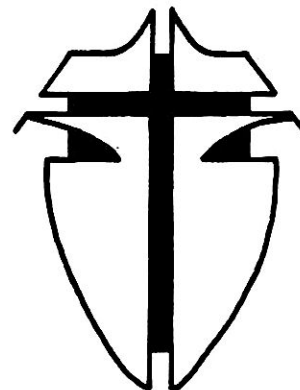



Many Zen see the Alliance as an evil empire and work for the Rebels in order to overthrow it. The Zen have no known enemies, other than their own brethren the Tza Zens and distant relatives called Sye-Men.

**TZA ZEN RIGELN:** There exist rogue Zen RigelN called the Tza Zen RigelN. The Tza Zen possess the same abilities as the Zen, but are the anti-healers, often seeking to destroy life, rather than preserve it. The Tza Zen are otherwise identical to their counterparts, except that the Tza Zen are evil and have an aggression modifier of +15, instead of -25. Tza reverse the power of their matrices to cause harm instead of good. They don't normally wear their power colors, opting instead to remain anonymous. The word Tza means "perverse" in Zen.

**GOVERNMENT:** The Council of Assizza is the ruling body on the planet KatreL. The government is a democracy and the elected officials must have mastered the level of the Hand of Assizza (20th level). This is necessary as the first act of a convening council and the members regularly join together and generate a powerful version of the Temple of Healing, before carrying out business matters. This is done to ensure the safety of its members and gain the blessings of Assizza on the council's decisions.

**CULTURE:** The Zen culture is characterized by non-violence. Almost all Zen follow the teachings of Assizza and do their best to "cure" those who do not. Zen RigelN are self righteous and tend to proselytize (attempt to convert others). Healers live in a communal society that advocates complete pacifism.

The Tza society consists of underground cults, meeting secretly to teach each other new powers. Many of them dabble in sorcery and necromancy. Most Tzas would never betray another Tza for they understand what it is to be hunted. Tza Zens don't always kill just for the sake of killing. Most "purify" only when necessary.

**PHYSIOLOGICAL MAKEUP:** Zen RigelN have blue blood. They look hauntingly like skeletons, and live to be 400 years old.

**WEAKNESS:** Healers are twice as likely to become addicted to BRIs as all other races. The effect of the drug is otherwise the same.

**QUIRKS:** The Zen spend up to 10 hours a day meditating on the universe and their place in it.

Zen are forever singing about something or another. They love to sing soft chants, those with a hundred verses or so.

**HISTORY:** The Zen RigelN have had the most peaceful of all histories. Their is an existence of spiritual evolution. "Material greed is the bane that fuels the fire of war". They entered the Age of Prosperity in 1322 BC. It lasted for over 1000 years. During this time, all Zen children were taught the Umog Radni Vishili (Power of Summoning). There was very little strife, only the tranquil peace of those who understand the value of life. It wasn't until 222 B.C. that the first Tza began to disrupt life on the planet KatreL.

The Zen RigelN never developed any type of space travel and were at peace when the Gen-Humans discovered them in 2086 AD.

**FAVORITE ITEM:** Zens don't normally keep objects of endearment.

**DRESS:** Healers wear long flowing robes. Like the Mutzachan, they take offense to anyone who intentionally steps on their train.

**HANGOUT:** A Zen spends much of his life, meditating in his (temple). The Zen sets up a temple anywhere he goes. The adobe need not have walls. It is measured by the size of the Corang (worship rug) that the Zen carries. Corang cost anywhere from 100-50,000cr and can be as big as 20m x 20m.

**COMBAT TACTICS:** Most healers never carry offensive weapons. If they do carry guns, they opt to use them only as a defensive measure.

**GENERAL OCCUPATION:** The Zen are usually hired as medic-technician or doctors. They are hired by all races to heal the sick and dying.

**VIEW ON LIFE (Zen):** This is the most precious commodity and must be preserved whatever the cost.

**VIEW ON LIFE (Tza):** I like making sculptures of others by mending their bones into interesting shapes and configurations.

**WAR (Zen):** The greatest abomination.

**WAR (Tza):** It cleanses the environment of inferior species.

**ALLIANCE (Zen):** This body serves a good purpose. Though a more peaceful means should be employed to achieve these goals.

**ALLIANCE (Tza):** It can be utilized to further my studies. I wish it followed a more potent policy on genocide.

**UNIVERSE (Zen):** It is breath taking and majestic.

**UNIVERSE (Tza):** The universe is impure in its genetic makeup. I shall dispose of the weak and worthless.

**FAMILY (Zen):** We are all family.

**FAMILY (Tza):** The Zen nation has done me wrong. My own people banish me for what I am. So what good is family?

**SELF (Zen):** I am the preserver of life. I only take mercenary employment to aid the wounded.

**SELF (Tza):** I am the Reaver. I destroy things which have no purpose. I often derive pleasure from someone else's pain. But I have been wrongfully driven to such acts.

#### NOTABLE ZEN RIGELN STATEMENTS

I am your humblest servant.  
I believe that the purest emotion is that of love.  
The greatest love is the love of others.

#### NOTABLE TZA ZEN STATEMENTS

Whoops! He died. Oh well!!!  
I don't mind operating without anesthesia.  
Looks like we lost another one.



# SETTING UP THE BASICS

**ALL RIGHT!!!** Now it's time to roll up a character. You've read through the race descriptions and should have a pretty good idea of the type of Battlelord that's right for you. Now you'll build him from the ground up. Don't worry. Creating him won't be your retirement project, it's done in a step by step process that doesn't take forever. You don't have to look all over the place for the necessary information. It's all right here.

Each step in creating the character is numbered and everything may be cross-referenced to the character sheet which follows the general outline of Setting Up the Basics. Simply read down the lists and fill in the appropriate section on the sheet. Most of your time will be spent choosing your vital statistics, occupational skills, and buying toys, not looking around for basic information. Isn't that the way things should be?

## 1. NAME

Choose any name that you want for your character. Use some imagination. Come on!!! Henry the Mutzachan isn't exactly as thrilling as Cathazar the Destroyer. I don't know. Play around with it and see what you come up with.

## 2. RACE

Battlelords of the 23rd Century has 12 basic races/species that players may choose from. Select the race that you think is the most fun and challenging for an individual of your temperament. The general occupation of each race accompanies the race description.

## 3. and 4. HEIGHT AND WEIGHT

The next step in rolling up a character is to determine height and weight. These are governed by race. To determine the height and weight of a character, simply roll the number of dice indicated in the table, then add it to the stated minimum for the race.

- BH:** Base height: (expressed in inches.)
- AH:** Added height: Roll the dice and add the result to the base height.
- BW:** Base weight: (expressed in pounds.)
- AW:** Added weight: Roll the dice and add the result to the base weight.

### HEIGHT AND WEIGHT TABLE

RACE	BH	AH	BW	AW
Chatilian	48	d12	50	d6x10
Cizerack	48	d6	250	2d8x10
Eridani	72	d12	180	2d10x10
Gen-Human	60	2d10	100	2d6x10
Human	60	2d10	100	2d6x10
Mazian		Special	30	d4x10
Mutzachan	48	d12	60	2d4x10
Orion Rogue	60	2d10	100	2d8x10
Phentari	72	d12	180	d12x10
Python Lizard	96	d12	400	5d4x10
Ram Python	108	d12	600	4d10x10
Zen Rigeln	84	d12	160	2d6x10

**Height Conversion:** Multiply the result by 2.54cm.

**Weight Conversion:** Divide the result by 2.2 kg.

## 5. SIZE CLASS

Now there is always one thing that has to be somewhat difficult. Many systems give an average size for the race. But certain individuals are taller than others and weigh more. The height and weight of a person determine his overall size. Larger targets are easier to hit. So we have to struggle through the boring task of finding out just what size your character is. If you are a Mazian, don't worry. You are always size class 1. Python races need not worry either. You guys are huge and are always size class 8. If your character is any other race, then you have to figure out your size class. Find the appropriate height and weight brackets below and add up the total of the two. The result is your size class. **Example:** Your character is a Human. He weighs 225 lbs and is 69 inches tall. His size class equals 3+2 = size class 5.

40-110lb = +1 to size class.	49-59in = +1 to size class.
111-200lb = +2 to size class.	60-71in = +2 to size class.
201-400lb = +3 to size class.	72-83in = +3 to size class.
401lb+ = +4 to size class.	84in+ = +4 to size class.

## 6. BODY POINTS

Body points (BPs) represent the total amount of damage that the body can withstand before the character falls unconscious. A person loses consciousness when he reaches zero body points. A character normally dies when he has reached -10 body points. This is subject to certain modifiers which are covered in Chapter 1, under Constitution.

Chatilian:	1+d6	Mutzachan:	1+d6
Cizerack:	7+d10	Orion Rogue:	2+d6
Eridani:	5+d8	Phentari:	8+d6
Gen-Human:	4+d6	Python:	12+d12
Humans:	2+d6	Ram Python:	16+d12
Mazian:	2+d4	Zen Rigeln:	4+d6

## 7. MOVEMENT

Movement is expressed in the form of three different movement numbers. Each number denotes the distance that the character travels in a given mode over a certain period of time. The first number represents the distance a character can sprint in one second (expressed in meters). This assumes that one is already moving. From a standstill, a character moves half the normal stated number. The second number indicates the distance that a typical person of that race can walk in one hour (expressed in kilometers). The final number denotes the distance that the individual can travel in one day, without exerting unusual effort, (also expressed in kilometers). The three numbers are written down on the character sheet in the order in which they appear below.

Sprint/Hour/Day			
Chatilian:	07/08/56	Mutzachan:	06/08/56
Cizerack:	20/13/104	Orion Rogue:	08/08/64
Eridani:	10/08/96	Phentari:	12/10/80
Gen-Human:	09/08/64	Python Lizard:	07/13/120
Human:	08/08/64	Ram Python:	07/14/140
Mazian:	02/01/12	Zen Rigeln:	08/08/72

Note: A Mazian replicating a creature and using an IFN can move at the speed of that creature.

## 8. NUMBER OF ATTACKS

Characters often find themselves in hand to hand combat. The number listed below indicates the number of attacks that a character can make with hands, feet, tail, and or mouth in a single hand-to-hand melee segment (3 seconds). Additional attacks earned from Hand To Hand combat skill are added to the total number of attacks, not to each individual hand attack.

Chatilian:	2 punches	Mutzachan:	2 punches
Cizerack:	2 claw+bite	Orion Rogue:	2 punches
Eridani:	3 punches	Phentari:	2 tentacles+bite
Gen-Human:	2 punches	Python:	2 claws+bite+tail
Human:	2 punches	Ram Python:	2 claws+bite+tail
Mazian:	1 ooze	Zen Rigeln:	2 punches

## 9. DAMAGE PER ATTACK

All hand to hand combat does damage to the opponent. There are two types of damage given by hand to hand combat: actual and temporary. Actual damage can kill a character quickly, whereas temporary damage doesn't. Actual damage is done on a point for point basis. All temporary damage is 1/10 actual damage. Races such as the Cizerack and the Pythons do real damage when they attack. This is due to their sharp talons and teeth. Strength bonuses are applied to all hand to hand attacks, whether they are actual or temporary.

When a character uses up his total body points in a combination of actual and temporary damage, it is assumed that he has fallen unconscious. Temporary damage, like bruising and battering, inhibits one's actions for only a matter of hours or days. Actual damage must heal over days, weeks, or even months. Players should be advised that punching armor is considered unhealthy and tends to break your hand. The following lists the damage yields by the various races. Those races that do actual damage are marked with an asterisk.

Chatilian:	1 point	Mutzachan:	1 point
*Cizerack:	1-2/1-2/1-3	Orion Rogue:	1 point
Eridani:	1 point	Phentari:	1-2/1-2/1-3
Gen-Human:	1 point	*Python Lizard:	1-2/1-2/1-4/1-3
Human:	1 point	*Ram Python:	1-2/1-2/1-3/1-3
Mazian:	Special	Zen Rigeln:	1 point

Note: The Phentari tentacles do temporary damage, but the Phentari bite does REAL damage.

## 10. VISION

What is 20/20 vision? This arbitrary frame of reference was used by humans in the 19th through 21st Centuries. It is a number used to describe what a human can clearly see at 20ft (about 7 meters). This measure of sight has long since been replaced by the Ranging System.

The Ranging System uses a human body as the reference point and measures the distance at which an individual can clearly spot a human shaped figure in a given time period. The system measures distance in meters and represents a 10 second interval. Add up all distance and racial modifiers to determine your chance to CLEARLY see a man-size creature at the stated range. The appropriate range brackets are given below. **ONLY THE MODIFIER IS WRITTEN DOWN ON THE CHARACTER SHEET!!!**

Example: A Phentari has a 40% chance to spot a human sized object at 75m.

1) 01-05m:	300%	5) 51-150m:	25%
2) 06-15m:	250%	6) 151-300m:	10%
3) 16-25m:	150%	7) 301-750m:	05%
4) 26-50m:	75%	8) 751-2000m:	01%
Chatilian:	-20	Mutzachan:	+10
Cizerack:	+75	Orion Rogue:	00
Eridani:	+10	Phentari:	+15
Gen-Human:	+05	Python:	-100
Human:	00	Ram Python:	-75
Mazian:	None	Zen Rigeln:	+10

Note!!! Mazians can't see at all. They use sonar. See Mazian.

## 11. SMELL

The olfactory sense allow characters to smell things. The range of smell depends on the strength of the odor and the relative ability of the individual to discern the presence of that odor. This game uses 20 meters as a frame of reference. It is the range at which humans can smell STRONG odors, like the smoke of a campfire. The Battle Master will determine the ability of characters to smell when the situation warrants. Write the number in the appropriate section of the Player's Character Sheet. **ONLY THE MODIFIER IS WRITTEN DOWN ON THE CHARACTER SHEET!!!**

Example: A Ram Python would have a 180% chance to smell something at 08m.

1) 01-03m:	200%	5) 21-50m:	05%
2) 04-05m:	150%	6) 51-100m:	-20%
3) 06-10m:	100%	7) 101-200m:	-50%
4) 11-20m:	25%	8) 201-500m:	-200%

Chatilian:	-15	Mutzachan:	-10
Cizerack:	+50	Orion Rogue:	00
Eridani:	+05	Phentari:	-15
Gen-Human:	+02	Python:	+100
Human:	00	Ram Python:	+80
Mazian:	+75	Zen Rigeln:	+10

## 12. HEARING

A normal individual (human) can detect the movement of another man-sized creature at a range of 10 meters. This assumes that the human is listening intently and the target creature is making a normal amount of noise. There is a 100% chance to hear them under optimal conditions. The chance to hear a man sized creature at the various ranges drops off significantly. The following table lists the modifiers to detection based on range and race. The BM will add modifiers to the ranges, depending on the circumstances. The hearing range of an average human is used as a reference. Add up the range modifiers along with the racial modifiers to determine the chance to hear a "human sized" noise.

Example: A Chatilian would have a 10% chance to hear something at 40m.

1) 01-03m:	200%	5) 21-50m:	05%
2) 04-07m:	150%	6) 51-100m:	-20%
3) 08-10m:	100%	7) 101-200m:	-100%
4) 11-20m:	25%	8) 201-500m:	-200%
For each additional 50m: -50%			

Chatilian:	+05	Mutzachan:	-05
Cizerack:	+150	Orion Rogue:	00
Eridani:	+20	Phentari:	+10
Gen-Human:	+05	*Python:	+65
Human:	00	*Ram Python:	+65
*Mazian:	+100	Zen Rigeln:	-10

\* These races sense vibrations mainly through the ground. A -50% penalty is incurred if the majority of their body isn't touching the ground when scanning. These races also can not effectively scan while wearing body armor and incur a -20 penalty when attempting to do so on top of any other penalty.

## 13. PLANET OF ORIGIN

The planet that the individual comes from depends on the race he chooses. The following table lists the choices of planets for each race. Characters gain an automatic 2nd level of proficiency in survival in the climate of the planet chosen, OR he is knowledgeable about urban



survival and gains second level in that skill. (i.e. he knows how to find places to shop, sleep, and live comfortably). **The awarded skills cost nothing in the initial character generation.** After the individual has chosen a birth place, the name is written in the appropriate section of the character sheet.

**Chatilian:** Chatil: (deciduous) Fomalhaut System

**Cizerack:** Cashoulis: (deciduous) 61-Verginis System  
Shiras: (desert) 61-Verginis system  
Avisham: (sub-arctic) CD-51 System  
Shavis: (desert) LFT-302 System

**Eridani:** Eridine: (methane) Eridani System  
Jani: (methane) Eridani System  
Jbar: (methane) CD-18 System  
Canton Emirates: (methane) CD-18 System

#### Gen-Human and Humans:

Earth: (deciduous) Sol System  
Dioligt: (deciduous) Orionus System  
Basisa: (tropical) Omicron System  
Zidra: (arctic) Dascisuis System Andromeda

**Mazian:** Karas: (tropical) Char System  
Kzag: (tropical) Lelande 25327 System  
Cira: (tropical) Antares System  
Kobul: (deciduous) LFT-302 System  
Zalimar: (tropical) Beta Comae System

**Mutzachan:** Trishmag: (radiation, arctic) Cygni-A  
Tamir: (radiation, desert) Epsilon Indi  
Vokkash: (radiation, desert) Epsilon Indi  
Tora-Mikash: (desert) Sigma Draconis  
Tragigmi: (radiation, arctic) LFT-1747  
Uranus: (methane, arctic) Sol System

**Orion Rogue:** Taos: (tropical) Orionus System  
Baffak: (arctic) Delta Eridani System  
Batrim: (arctic) Delta Eridani System  
Draman: (tropical) Ross 41 System  
Nabir: (deciduous) Ross 41 System

**Phentari:** Phena: (methane, arctic) Tau Ceti System  
Tau-Phena: (methane, arctic) Tau Ceti  
Werimus: (methane, arctic) Tau Ceti System  
Phelinar: (methane, arctic) Piscium System

#### Python &

**Ram Python:** Pythos: (tropical) Floridian System  
Ashira: (tropical) Floridian System

**Zen Rigel:** Karel: (deciduous) Rigel System

**NOTE!!** Choosing a particular planet provides survival skills in that particular environment, or one can choose 2 levels of proficiency in Urban Survival. **THIS DOESN'T MEAN THAT THE CHARACTER CAN SURVIVE WITHOUT PROTECTIVE GEAR IN THAT ENVIRONMENT.**

**Example:** A Gen-Human born on Jani can not breath methane. It merely means that he or she could survive, given the proper breathing apparatus, in a methane environment. The Gen-Human could avoid particular hazards common to that environment.

## 14. HONOR

It's serious business. Many a warrior has sacrificed his life in the name of honor. Honorable characters gain bonuses to all experience points received from the Battle Master. Players, however, should refrain from choosing an Honorable character just to gain extra experience points. Players who don't play according to their beliefs can be penalized by the BM. Any character can be honorable, but it is optional. Players merely choose from the honor subclasses below. Each subclass has certain bonuses that are automatically applied when the class is chosen.

**Fanatic:** One who expresses extreme enthusiasm or zeal. The character does not tolerate any transgression against his beliefs. He always acts in accordance with his moral convictions, regardless of the consequences. **Note:** The character should outline his convictions in as much detail as possible, and he **MUST** follow these at all times.

**Honorable:** The individual has strong moral and ethical convictions and follows these ideals rather closely. He may tend toward overt aggression if he feels he has been thwarted or insulted.

**Average:** A normal person of the galaxy. These people just deal with life as it comes.

**Dishonorable:** Those individuals who are not honorable are not necessarily bad people. They just don't follow any specific moral code. Their given word means little. They sometimes make promises that they don't intend to keep.

**Slime:** These guys are the antithesis of the fanatics. Their word means less than nothing! They sometimes lie just to subvert the intentions of others. Nothing they say can be trusted. They don't lie all the time, only when it counts. **Note:** These people are out for themselves, AND out to make others miserable. For whatever reasons, (i.e. bad childhood), they are real slime-balls.

**Fanatical:** +20% to all experience points from BM.  
+40% chance to berserk.  
+15% to suicidal berserking.

**Honorable:** +10% to all experience earned from BM.  
+20% chance to berserk.

**Average:** No bonuses.

**Dishonorable:** +05% to all experience earned from BM.  
10% likely to turn on allies if profitable and there is no risk.

**Slime:** +10% to all experience earned from BM.  
60% to betray allies for profit or convenience.  
50% to run as opposed to surrendering or facing bad odds. (let the grunts handle it)

## 15. ALIGNMENT

Alignment measures one's disposition towards life in general. It gives us an indication of how an individual will react to others. There are two basic parameters that determine the alignment of a character. First, the person's regard to the laws of society. Second, his perception of good and evil. Abiding characters recognize the need for order and discipline and they accept these general precepts. Most future societies are Abiding. Deterministic characters tend to be more rebellious and spontaneous, seeing life as a continuous stream of unfolding events. They favor anarchy over law and order. Evil characters are by their nature malicious, seeking to be cruel and dominate others. Neutral persons see life as a balance between all opposing forces. They make decisions based on circumstances, rather than on value systems. Neutral characters recognize good and evil and see themselves as something in-between. The following list gives the various alignments that players may choose from. Create more if it suits you.

**ABIDER:** Follows a strict interpretation and prosecution of the law. Abiders work for the common good of the people. The search for truth and justice is their fundamental reason for living. Beauty and life are held in the highest regard. Characters should follow this alignment over others if they wish to eventually be accepted into the Galactic Services. A law abiding character acts in the following manner as a general rule of thumb: (there can be exceptions due to extenuating circumstances).

- Follows the chain of command.
- Won't kill prisoners.
- Won't break the society's laws.
- Does the utmost to preserve all life.
- Helps the needy.

**INFIDEL:** This alignment sees the need for rules and discipline, but holds life in utter disdain. Infidels view their fate as predetermined to rule others through subjugating the masses to their own wills. One generally follows these guidelines:

- Kills lifeforms without chagrin.
- Exerts power over others in order to rule them.
- Takes short cuts to get things done.
- Keep promises. He may attempt to pervert the meaning.

**FATALIST:** Take the middle of the road view between good and evil. Everything that takes place is meant to keep harmony in the universe. Fate is regulated. Chaos upsets the balance of things. Fatalists want to:

- Moderate the actions of others.
- Keep the balance between good and evil.
- Keep order.

**POSITIVE FATALIST:** There is little need for law or order. "We are generally acclimated toward the continued existence of life and the welfare of all living organisms." Good will eventually prevail.

Things will work out for the best.  
 "I am interested in the general welfare of others, but I just don't care how society goes about achieving it."

**NEGATIVE FATALIST:** Agree with the premise that law and order are irrelevant, but believe that the destiny of the universe is the eventual extermination of good by the more efficient evil.

"We are all inherently evil."  
 "Cynics are actually realists."  
 "I don't believe that people are necessarily good. On the contrary, most of us look out for ourselves and that makes perfectly good sense to me."

**REBEL:** Those who are rebels see the need to preserve life and perpetuate beauty and love, without the constraints of rules and regulations. Rebels believe that the essential truths are self-embodied and that any given action, unless unjustly cruel, is acceptable. "The Galactic Alliance by it's very nature is unjust and evil. The ancient philosophy of democracy should replace it. Change is the only way." This alignment follows these general courses of action:

- Achieves good by whatever means necessary.
- Destroys evil by any means.
- "I'm a revolutionary. I can effect a change."

**DISRUPTER:** Those who believe in the precepts of this alignment hold all in contempt; law, order, life, etc. They do whatever is necessary to insure their own gains. Their lives revolve around the spreading of evil and chaos.

"I kill when I feel like it."  
 "Everything is fine as long as I come out on top."  
 "Word of honor doesn't exist. It is an inane concept."

**DETERMINIST:** Everything is random, thus the overall effect is balance. Good and evil are complementary while law is unnecessary. A person determines his own destiny. This alignment follows the ancient precepts of anarchy.

"I exist for myself."  
 "I can justify doing anything as long as I'm not forced to do it."

**POSITIVE DETERMINIST:** The individual follows the same basic precepts of the determinist philosophy, but is predisposed toward good. Characters are neutral overall, but lean toward good instead of bad.

"It would really be out of my way to help that Gen-Human, but maybe I could."

**NEGATIVE DETERMINIST:** Tending toward evil, though basically neutral. Negative Determinists are predisposed toward acting out cruelties to feed their own ego.

"This Python isn't bothering me and I really shouldn't shoot at him, but why not?"

## 16. SOCIAL STATUS

Characters are born into various social classes. The class that a character is born into has a direct impact on his starting money. The class status denotes the general economic welfare of the character. Class also affects how one is viewed by others within the proximity of his home. Neither Python race ever comes from upper class. If the dice roll indicates wealthy or higher, re-roll. Mutzachans never come from poverty status. Again, if the dice roll indicates that a Mutzachan is poverty stricken, re-roll. The following table lists the basic starting money for each race. After the amount has been determined, players roll on the Class Table and adjust the amount of money accordingly. Once determined, the status is written in section 15 and starting money is notated as cash on hand.

Characters may opt to take out a loan, on the order of magnitude equal to their starting money. They must pay this loan back at a 10% monthly interest rate. The maximum that any character can receive from a loan is 10,000cr, regardless of how much money he actually has. Furthermore, characters may opt to take out a credit card for 500cr. They must pay it back at a 25% monthly interest rate.

**ROLL ON THE MONETARY DISTRIBUTION TABLE AND ADJUST THE RESULTS ACCORDINGLY. THE FINAL RESULT IS YOUR STARTING MONEY.**

### SOCIAL STATUS DISTINCTION TABLE

SCORE	CLASS	MOD
01-10	Poverty:	-50%
11-30	Lower:	-25%
31-50	Middle:	0%
51-70	Upper Middle:	+10%
71-90	Content:	+25%
91-96	Wealthy:	+75%
97-98	Rich:	+200%
99-100	Loaded:	+300%

### RACIAL MONETARY DISTRIBUTION

Cizerack	800-3200	8d4x100	Mutzachan	1500-9000	5d6x300
Chatilian	1200-7200	4d6x300	Orion	900-5400	9d6x100
Eridani	600-3600	6d6x100	Phentari	600-3600	6d6x100
Gen-Human	900-5400	9d6x100	Python	500-2000	5d4x100
Human	800-4800	8d6x100	Ram Python	500-2000	5d4x100
Mazian	600-2400	6d4x100	Zen Rigel	600-3600	6d6x100

## 17. PRIMARY OCCUPATION

This represents an individual's basic job profession. Most characters begin the game with 50 proficiency points. A minimum of 25 of these must be expended in one general field if the character is considered to have a primary occupation. This is optional. NOTE! Characters can secure higher wages for their services if they have a primary occupational skill. Players simply choose among the various job skills of the particular field at the beginning of the game. Characters without a concentration in a field simply leave this section blank. SEE OCCUPATIONAL SKILLS FIRST BEFORE FILLING IN THIS SECTION.

## 18. SECONDARY OCCUPATION

Any character who expends 15 points in a field, is assumed to possess a secondary occupation. Characters have a viable job skill when seeking employment. They can gain entry level jobs in that field. Just what are the bonuses for having a secondary occupation? Well you won't have to flip burgers at the local Burger Corp, and you just might get some extra cash. SEE OCCUPATIONAL SKILLS BEFORE FILLING IN THIS SECTION.

## 19. EXPERIENCE POINTS

Denotes the amount of experience that a character has gained while operating in the field. As one gains experience points, one is able to learn new skills. Beginning Characters start with 0000 EXP.

## 20. EXPERIENCE POINTS AVAILABLE

These are the total unused experience points that a character may opt to use to gain new occupational proficiencies or powers. (You don't have any EXP's so you can't have any that aren't spent).

## 21. LANGUAGES

All races begin the game knowing Earth English and their own racial language. SEE OCCUPATIONAL SKILLS

## 22. SPONSOR

The Sponsor is the charter company that the character works for. Normally, a character signs a Hazardous Duty contract when first obtaining full time employment. The contract obligates the hiring to serve the company for a specific length of time, usually 2-8 years. Most characters start out working for a company before they act as Independents. The company that one works for has a direct affect on what type of missions the character will be sent on. It is important to mention that companies sub-contract out work to others. Just because a company picks someone up on a charter, doesn't mean that all their missions will be confined to that company's priority field of endeavors.

NOTE! Most companies insist that employees wear the corporate crest when in the field. One's insignia has an effect on how others treat them, increasing/decreasing prestige and charisma as called for. Given below are the top ten money grossing corporations along with some pertinent information about each of them.

Battle Masters feel free to assign the Sponsor as you desire.

You are also encouraged to make up your own companies as you wish

**1. Telydyne Syndicates:** Telydyne is the most powerful mega-corporation in the galaxies. It employs over 2 million people, with a GCP (Gross Corporate Profit) of 450 trillion credits per year. Telydyne has expanded its operations into the Fornax, Sculptor, and Andromeda galaxies. The company carries out every type of activity imaginable, specializing in deep space construction/exploration and espionage. Characters who work for Telydyne are entitled to a starting salary which is 10,000cr above the industry norm. The Telydyne insignia is a Screaming Eagle pierced by a lightning bolt. Charisma increase when in uniform: +10.



**2. Space Systems Development Corporation (SSDC):** SSDC is one of the most reputable, big name companies in the Alliance today. It employs 5 million personnel, with a GCP of 425 trillion credits per year. SSDC has recently expanded its operations into the Lesser Magellanic Cloud, Greater Magellanic Cloud, and M33 galaxies. It also has bases in the Virgo, Canes Venacti, and NGC-3501 superclusters. The Space Systems Development Corporation specializes in deep space exploration and is often subcontracted by other firms to investigate planets, set up the appropriate environment, and terminate any hostile lifeforms before settlers are brought in. Characters who work for SSDC must sign on for a minimum of 6 years and automatically receive a 20,000cr signing bonus. It should be pointed out that SSDC has the highest fatality rate of any of the BIG TEN. Charisma increase in uniform: +20.

**3. Eridi-Corp:** Eridi-Corp is short for the Eridani Corporation. Eridi-Corp is a subsidiary of the Eridani government. It exists to perpetuate and strengthen the Eridani people. Eridi-Corp carries out all types of activities, but specializes in mercenary leasing. It is primarily Core World based. It carries out some activities in the Andromeda galaxy and has advance base camps in the Sculptor Local Group. Phentari and Orions should reconsider getting a job here, because Eridi-Corp isn't abashed about sending them out as "expendables" to such pleasant places such as the "Death World" in Andromeda. Eridi-Corp is big on employee satisfaction and does just about anything to help out its personnel. All Eridi-Corp employees sign a 10 year contract and receive intense military training (4-24 proficiency points of military training for free). It is required that all prospective Eridi-Corp employees have a primary military occupation. Characters must also spend 1/3 of their accumulated proficiency points on military related skills (weapons, military, vehicles, espionage...) Charisma increase in uniform: +35.

**4. Balshrom Science Corporation:** The most powerful weapons manufacturing firm in the galaxies. It is the front runner in all weapons sales categories (as if you didn't know). Almost 1/3 of all weapons sold are produced by this mega-corporation, or one of its many subsidiaries. Balshrom leases mercenaries, operates an extensive spy network, and owns several mining operations, in addition to producing weapons. It has a GCP of 128 trillion credits per annum. Balshrom requires that all of its personnel possess a secondary

occupation in a weapons class. Persons must sign on for a 8 year hitch. All employees are entitled to a 25% discount on all Balshrom Science Corporation products. The Balshrom insignia is a Devastator Omega cannon. Charisma increase in uniform: +10.

5. **AMC:** The Asteroid Mining Consortium is the largest mining firm in the known Universe. It subcontracts SSDC for its pre-operations advanced planetary reconnaissance (POAPR). AMC employs 10 million workers. It runs operations in every quadrant of the Local Group. It's mainstay is the element Titrutium, used to power the jump drives on board starships. All prospective employees must have a minimum of 2 levels of mining skill (planetary or deep space). The AMC carries out an advanced espionage program against its competition and has been known to hire an assassin or two. Management is considered to be ruthless, but fair. The AMC offers the highest signing bonus of any company, 35,000cr. Prospective employees need only sign on to a 3 year contract. Charisma increase in uniform: +05.



6. **Chatilian Interest Firm:** Subcontracted by most big corporations company from time to time. Employees call it "Spies 'r' Us". The firm employs mostly Chatilians, Humans, and Mazians, with a smattering of others thrown in for good measure. It is reported that the Chatilian Interest Firm actually hires special personnel to spy on their regular personnel. Personnel receive training in any military or espionage skill for 1 point less than the norm and receive a 10,000cr hazardous duty bonus every year. Personnel, working for the Chatilian Interest Firm, never wear uniforms.

7. **BioCyberdyne (The BC):** The BioCyberdyne company produces cybernetic, synthetic, and biogenetic quasi-lifeforms. It is the most prominent organization of its kind. It employs 5 million workers and has a standing scientist corps of some 500,000 brilliant minds. Some of the most prestigious names in the Universe work for the BC. Fact: It is rumored that the BC is really the driving force behind the Anarchist Rebellion Movement. This terrorist organization is predisposed toward the complete and utter destruction of the Alliance. BioCyberdyne is the focus of the largest criminal investigation in Alliance history. All prospective employees are automatically put under surveillance by the Galactic Police.

The BC offers free training (20 points worth) to any worthy mind. Characters must have a minimum of 80 IQ to even be considered for employment. The BC also has a reputable core of matrix controllers enlisted in its ranks. All MCs who work for BioCyberdyne pay 50% of the list cost to learn new matrices and training requires only half the stated time. MCs are guaranteed a full time Mentor. The company insignia is a red brain on yellow background. Charisma increase in uniform: +05.

8. **Orionus Konglomerates:** Orionus Konglomerates operates the largest non-military fleet in the galaxies with about 5000 ships currently in service. It trades in every commodity imaginable and operates primarily in the business sector. The company's headquarters is located on Taos, the trading hub of the Alliance. Company employees receive a lifetime of free travel anywhere within trade routes and have a yearly salary bonus of 20,000cr. Orionus employees are arguably the happiest around and the company prefers it that way. Contracts are negotiable and characters get a lifetime 10% discount on any item that the company stocks. The Orionus emblem is the Galactic credit sign. Charisma increase in uniform: +15.

9. **Erectus:** Erectus designs and produces space stations and related deep space materials. This mega-corporation is currently under indictment for fraud. It carries out a multitude of unscrupulous activities and is reputed to hire any "bum" off the street. Erectus does offer 30 skill points worth of training for free in an intensive 2 year training program. Their motto is "Buildings Without Bolts Fall Down". Erectus is renowned for its competent graduates. Erectus insists that prospective employees sign on for a 2 year term. Charisma increases when in uniform: -10.

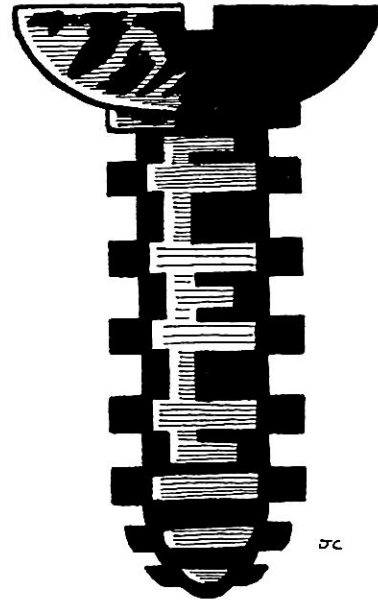

10. **Cyber Research Institute (CRI):** The largest producer of cybernetic equipment in the Alliance. It hires out mercenaries to bring in additional revenue. CRI promises to provide cybernetic replacement parts to all individuals who lose their natural limbs (due to hazardous duty) for free. All newly hired personnel may purchase 200,000cr worth of cybernetic equipment at no cost. The company only rosters 50,000 mercs and duty normally has a 50% attrition over the 5 year contract period. The insignia is a highly stylized Cyborg. Charisma increase in uniform: +15.

## 23. SALARY

The player contracts himself out to his or her sponsor for a certain salary. The player negotiates his position, based on his occupational skills and the length of the contract. Players with a primary occupation or expertise in a field are obviously paid more money. YOUR STARTING SALARY DEPENDS ON THE OCCUPATIONAL SKILL THAT YOU CHOOSE AND COMPANY SIGNING PROCEDURES. SEE OCCUPATIONAL SKILLS IN THE NEXT CHAPTER.

## 24. RANK

All of the Galactic Military Services, along with most galactic corporations, function according to some type of rank structure. The Battle Master will determine the appropriate rank of party personnel according to mission necessity and leadership capability. Player characters gain 07% salary bonuses per level of rank (SEE CHAPTER 9).

## 25. AWARDS

Players receive commendations for various reasons. These are not a joke. Most large corporations utilize a paramilitary hierarchy. Awards play a direct role in the promotion of characters up the great military and corporate ladders. Charisma scores are modified if the player is in uniform and or is displaying his medals. SEE BATTLE MASTER'S SECTION

## 26. BLACK MARKS

Black marks depict blemishes on a character's record. Characters receive them for failure to follow instructions and inappropriate actions. They warrant respect because too many black marks can cost an individual a rank, position, or MONEY. Be careful and always try to keep this blank.

## 27. SURVIVAL MATRIX ROLL (SMR)

All player characters are susceptible to different attack forms which are not governed by normal discharge of weapons. These specific attacks can incapacitate, maim, or kill an individual instantly. A character's survival matrix number denotes his percentage chance to survive unprotected after being exposed to a special attack form. The victim rolls the dice against the survival matrix table. If the dice roll is lower than the survival matrix number, then the individual has taken minimum damage (all damage dice are halved) or none at all (dependant on the attack form). The character must make successful saves against the attack form every round thereafter, while he is still exposed to the agent. At any time that the character fails to make a successful roll, he is then subject to the full damage from the attack form. Individuals receive bonuses to their survival matrix rolls if they have high constitution scores. The modification is applied directly to the SMR number. The following table gives the survival matrix rolls for each character race.

**SURVIVAL MATRIX TABLE**

RACE	CHE	RAD	BIO	MEN	POI	SON	ELE	FIR	ACD	CLD
Chatilian	20	17	10	80	20	72	30	15	15	35
Cizerack	25	20	25	28	26	07	26	30	20	48
Cyborg	40	-	-	-	-	-	25	-	50	-
(for attachments, otherwise by race)										
Eridani	45	23	35	65	48	25	50	10	15	99
Gen-Human	17	15	15	50	20	25	40	20	20	42
Human	17	15	12	45	18	20	40	20	20	40
Mazian	55	20	95	24	75	05	05	12	05	20
Mutzachan	07	97	03	65	10	20	60	60	10	35
Orion	20	15	15	35	20	25	36	20	15	40
Phentari	70	30	50	40	60	20	45	10	35	99
Python	40	25	25	10	36	85	50	08	40	20
Ram Python	40	25	27	08	38	85	50	12	40	15
Zen Rigel	18	23	45	30	35	35	40	20	15	60

NOTE!!! Characters may purchase equipment to protect themselves from these forms of attack.

CHE=Chemical	RAD=Radiation	BIO=Biological
MEN=Mental	POI=Poisn	SON=Sonic
ELE=Electricity	FIR=Fire	ACD=Acid
CLD=Cold		

## I WAS JUST GROWING UP (Optional)

We all grew up differently. We also display certain peculiarities within our personalities. It happens. Some good things happened to me that didn't happen to you, and vice versa. These events shape our personality. They are all part of growing up. Players may choose from the following tables if they so desire, to round out their respective characters. The first catch is that you must first roll on Table 1 before rolling on Table 2. Once you have rolled on Table 1 you can roll on Table 2. If you roll 3 times on Table 1 you can roll twice on Table 2. This table tends to humanize the player characters and its use is optional.

Sometimes a roll is not reasonable for one reason or another. The Battle Master (and only the BM) can change the effects, or allow a reroll if some result is not rational. Example: A Mazian who rolls 81 (Mazians don't have an opposite sex) could reroll or change it to be that human females think you're adorable. The BM must approve of any changes.

**I WAS JUST GROWING UP TABLE 1**

01-03	Talks a lot (You never shut up).
04-06	Chain smoker (05% chance to contract cancer).
07-10	Organized (Take 1 free level of administration).
11-13	Incurable romantic (Sucker!!!)
14-16	Your breath is considered pungent. (Haven't you heard of toothbrush equivalents?)
17-19	Poor etiquette, (You fart and burp loudly in public).
20-22	Unconsciously drool all the time.
23-25	Flirtatious (You believe in the "hands on" philosophy).
26-28	Shy. (-05 to charisma).
29-31	Acrophobia (fear of heights).
32-34	Agoraphobia (fear of open places).
35-36	Claustrophobia (fear of closed spaces).
37-40	Aquaphobia (your mother dropped you in the water and you sunk).
41	Methodical (+05 bonus to skills checks).
42-45	Itchy trigger finger (05% chance to open fire without provocation).
46-48	Take a shower. You stink!!! (-15 to charisma score).
49-52	Politically active +05 to charisma.
53-55	Fashionable (I've got to buy that shirt. I've just got to!)
56-58	Racist (They can't be trusted. They are all the same, lazy and shiftless).
59-61	Narcolepsy (You fall asleep for no apparent reason).
62-64	Trivia buff (+10 to general knowledge skill checks).
65-67	Unlucky at love (You get stepped on all the time).
68-70	Cleptomaniac (You're too old for that stuff!)
71-73	Neurotic (Why do you always do that? It's annoying!)
74-76	Psychotic (I'm an orange and the world is trying to peel me).
77-80	Intuitive (+05% to intuition checks).
81-83	The opposite sex find you irresistible (You sexy thing you!)
84-86	Bone Head. (Subtract 05 from IQ and Intuition).
87-88	Spend Thrift (-05 to bargaining skill).
89-91	Drinking Problem (Bad hangovers and all!)
92-94	Blood Thirsty (05% chance to kill someone "for the fun of it.")
95-97	Schizophrenic (You never have to be alone).
98-100	You are the Coolest! (Add 10 to charisma score).

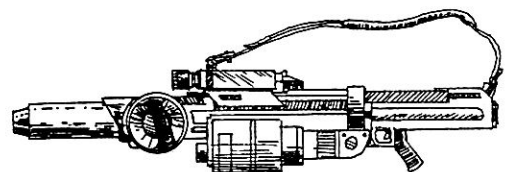



**I WAS JUST GROWING UP TABLE 2**

- 01-03 Showed mechanical aptitude as a kid (-1 mechanic skill cost)
- 04-06 A friend gave you 2 tickets to the Cyball Championships.
- 07-10 Given a chemistry set as a child (Take 2 levels of chemistry).
- 11-13 Born in the mountains. (Begin the game with 2 levels of mountaineering).
- 14-16 Spent part of adolescent years on the streets (+10 intuition and 2 levels of street smarts).
- 17-19 You found 1000cr and decided to keep it, instead of turning it over to the authorities.
- 20-23 Singer in a band. Had a hit single (Collect 1000cr royalties per month for life).
- 24-27 Mom works on a famous passenger liner (Tickets are 20% off)
- 28-30 Gourmet Chef (Take 5 levels of cooking).
- 31-34 You were a famous Cyball player (Increase charisma by 05)
- 35-37 Worked for two years on the spacedocks (Take 7 skill points from Deep Space Operations).
- 38-40 Video game master (All gunnery skills cost -1).
- 41-44 Terminal illness (But it is in remission now).
- 45-47 Once an aspiring actor (Begin the game with 1 level of impersonation and 1 level of disguise).
- 48-50 Fast (Add 3 to sprint number in movement section).
- 51-53 Spaceball pitcher (Take 3 levels of throwing).
- 54-57 Loved remote control toys as a child (Take 2 levels of remote piloting skill).
- 58-60 Card Shark (Take two levels of gambling).
- 61-63 Worked on a Mining Away Team (Begin the game with 2 levels of asteroid mining skill).
- 64-66 Worked at a crime lab. (Forensics level 2)
- 67-70 Able to reach deep hypnotic states while meditating (Take 2 levels of body equilibrium skill).
- 71-73 Built your own computer (Take 2 levels repair).
- 74-76 Drug user (You must spend 200cr a week to support habit).
- 77-79 Computer hacker (Take 2 levels of operation and programming).
- 80-82 Born in a freefall environment (Take 2 levels EVM).
- 83-85 War buff (Take 1 level of identify robots and 1 level of identify vessels).
- 86-88 Had to leave the nest early to learn a trade (Take 2 levels of any journeyman skill).
- 89-91 Historian (+10 to terrestrial knowledge score).
- 92-94 Math buff (-1 cost to any engineering and or science subskill).
- 95-97 Extremely generous (Leave 20% of all future monies accumulated with charities of your choice).
- 98-100 Inherited grandpa's PC-6 Pulse cannon.

**MURPHY'S LAW OF AVERAGES**

Character's backgrounds are often filled with unexpected ups and downs. Murphy's Law of Averages strikes and strikes hard. Players may choose to roll once or twice on the Fickle Finger of Fate table, if they wish. They may also roll once on any ONE of the Fortune Tables that is fitting to the race. The Python, Ram Python, Eridani, Cizerack, and Phentari races roll on the Warriors Fortune Table. Humans, Gen-Humans, and Orion Rogues, may use any table. Mazians use the Spy's Fortune while the Mutzachan and Zen Rigeln roll on the Matrix Controllers Table. Chatilians may roll on either the Spy or Matrix Controller Fortune Table. All results are final and the player MUST play with the character as it ends up. These tables can be NAAAAAAAASTY!

**FICKLE FINGER OF FATE TABLE**

- 01-05 Character receives inheritance of 1000cr.
- 06-08 Bad credit rating. Cannot obtain a loan of any kind.
- 09-10 Character is quarantined. Must pay fees of 300cr.
- 11-13 Good investment portfolio. Collect 3000cr.
- 14-15 Individual is considered Galactic fugitive. Must change identity with sponsoring Corporation.

- 16-17 Dad left you a new M-20 Blaster pulse cannon.
- 18 Bank error in your favor. Collect 3000cr.
- 19-20 The character catches a sexually transmitted disease that rots the body. Constitution is permanently lowered by 08%.
- 21-22 The character is a victim of serious accident. (Lose the thumb off one hand and 25 points of manual dexterity).
- 23 Involved in pirating. Collect 15,000cr. Beware!!! The Galactic Police have an all points bulletin out for you and have put a bounty on your head, set at 100,000cr.
- 24-25 The Rebels are trying to contact you.
- 26 Winner of the Galactic Super Lotto. Collect 2000cr per month for life.
- 27-28 You are a famous Cyball player. Add +10 to Charisma.
- 29 Competition firm is willing to pay you 40,000cr a year to spy on your company.
- 30 Accident partially blinds your character. All sighting checks incur a -50 penalty.
- 31-32 Win weekly Bingo game. Collect 1000cr.
- 33 Many political contacts throughout the Core Worlds.
- 34 Prison record. Can never hold government job or obtain credit cards.
- 35 Jaquassarious Phentari is looking for you.
- 36-37 Mate just had quadruplets: Medical fees of 1000cr to be garnished from wages; up to 50% of each paycheck.
- 38-39 Business partnership yields dividends of 500cr/mo. for life.
- 40 Blacklisted as informant. Teledyne Syndicates has placed a contract out on your life.
- 41-42 Cryziol warts cover your face. Reduce charisma by 35.
- 43 You have been granted your Class I Bounty Hunters license.
- 44 Contracted Magellan Malaria. Strength, I.Q., Constitution, and Manual Dexterity are permanently lowered by 20.
- 45 Relative works for Galactic Customs. All customs and weapons import taxes cost 1/2.
- 46-47 Mistaken identity. A bounty hunter is on your tail.
- 48 A renegade Phentari killed your entire family.
- 49 Character possesses amazing powers. Begin the game with 1st level proficiency in any 1 additional matrix controller field, regardless of race.
- 50 The GRS (Galactic Revenue Services) claim you owe the government 5000cr in back taxes. All efforts to correct the problem have failed and they're on the way to your domicile.
- 51-52 Law suit against corporation successful. Collect 5000cr.
- 53-54 You can accept a bribe for 5000cr.
- 55 Win brand new Rockwell Bayliner skimmer, valued at 25,000cr.
- 56-58 Close friend is high up in the government and owes you one.
- 59 Your uncle owns a trans-galactic starliner company. He likes you!! You can borrow one of his Bohemian class starcruisers, any time you want.
- 60 Slow learner. Gain new skill proficiencies every 2000 EXP.
- 61-62 Relative is sector chief in Galactic Police.
- 63 Your Dad gives you three new toys for your gun collection. Choose 5000cr worth of weapons.
- 64-65 You have won a two week stay at the 5 star Danstel Resort on New Terra.
- 66-67 Accident causes amnesia. Reduce starting skill points by 15.
- 68-69 You have a Ram Python for a friend. He is loyal as a puppy!
- 70 Won the opportunity to play Survival Warrior. If you survive, you win 50,000cr.
- 71-73 Crippling muscular disease during childhood. Lower strength by 20 points.
- 74-75 You are shot while walking the pet. You don't die, rather you blow your assailant's head off. There is 1000 in blank credit chits in his wallet. You can hear the approach of a police car.
- 76 Corporation Protege: Increase starting skill points by 15.
- 77-78 Mugged while walking the pet. (The neighborhoods are unsafe). Subtract 200cr from starting amount.
- 79-80 An Orion has vowed that if you ever own a spaceship then he will steal it.

- 81 Corporate law suit. Judge rules against you for 25,000cr to be paid over a 5 year period.
- 82 Possess a secret bank account, with 3000cr hidden in it.
- 83 You lose everything, betting on the ponies (i.e. you're broke).
- 84 Your spouse is divorcing you (or the equivalent). You must pay 20% of your earned monies over the next 10 years for child support/alimony.
- 85 Prison escapee. There is an all points bulletin out for you. You are considered armed and dangerous.
- 86-87 Accident mangles your body. Reduce agility and manual dexterity by 15 points each.
- 88-89 Your spouse is cheating on you.
- 90 You have been left an inheritance which includes a HAW-4 anti-tank system. The trust fund cannot be touched for 5 years.
- 91 Genetic perfection. Increase all vital statistics by 10 points.
- 92 Brain tumor. There is a 05% chance to blackout under extremely stressful situations.
- 93-94 Genetic mutation in favor of immunity to all known poisons.
- 95 Relatives own Trititium mine. Collect 2000cr/mo. for 10 years.
- 96 Inherited your grandfather's estate, valued at 1,000,000cr. The problem is that under the inheritance, you can never sell it.
- 97-98 The Rebels have put out a contract on you and your family.
- 99 You've been selected for a cybernetic research grant. Select 50,000cr worth of equipment. Free!
- 100 You have a terminal illness. You have a week or so to live.

### WARRIOR'S FORTUNE TABLE

- 01-05 Obtained training in swordsmanship at the famed Swintash school, on the planet Eridine. Gain +10 to hit with all edged weapons.
- 06-10 Trained under the tutorial of the Great Garsh of Pythos. Add +10 to hit with Ioken. Increase your aggression score by 15.
- 11-15 Accident: Exposure to toxic gas. Reduce constitution by 20.
- 16-20 Fragmentation grenade blew off 2 fingers on your right hand. Reduce manual dexterity score by 15.
- 21-25 Adversary is seeking you out to avenge the death of his sibling.
- 26-30 Excellent peripheral vision. Add +1 to reaction rolls.
- 31-35 Once a victim of a sonic attack. Reduce intelligence by 07.
- 36-40 Fast draw. Add -1 to combat initiative rolls.
- 41-45 Character was in the wrong place at the wrong time. Fallout from nuclear blast caused radiation sickness. Permanent side effects. Reduce strength by 15 and charisma by 35 points.
- 46-50 Extensive training with pulse weapons: Add +05 to all hit dice when using any type of this weapon.
- 51-55 Terrible aim. -15 on all attack rolls with ranged weapons.
- 56-60 Cowardice under heavy combat conditions. You have a 10% chance to run.
- 61-65 Extensive training with lasers. Add +05 to all hit dice when using any weapon of this type.
- 66-70 Previous combat training has made you mean. Increase aggression score by 10 points.
- 71-75 Your character tends to laugh in the face of danger. He has a 20% base chance to do so.
- 76-77 You walk with an air of command. Increase Military Leadership scores by 10 points.
- 78-80 Character graduated top in his class at MCS (Military Candidate School) on the planet Earth. Increase Military Leadership score by 20 points.
- 81-83 Character was the victim of a chemical attack. Constitution is reduced by 15. Vision is reduced by 25%.
- 84-85 Found small weapons cache with 2 grenades and a Beretta 9mm pistol.
- 86-88 Extensive training with archaic powder weapons. Add +05 to hit when using any weapon of this type.
- 89-90 Trench foot. Reduce agility by 07 points.

- 91-92 Good News: Your character won a poker game with some mercenaries. Collect 5000cr. The bad news is they think you cheated and are after you.
- 93-94 Guinea pig in pain tolerance experiment. Great success. You fight to -4 body points before losing consciousness.
- 95-96 Your character was dishonorably discharged from Galactic Services. He may not take out any loans, obtain credit cards, or hold any government office.
- 97-98 Great connections within the Services. You can purchase state of the art equipment for 10% off of list cost.
- 99-100 Automatic admittance into the Galactic Service of your choice.



### MATRIX CONTROLLER'S FORTUNE TABLE

- 01-05 Victim of a sonic attack. Reduce intelligence score by 05 points, and hearing by -50.
- 06-10 Training at the Mind School on the Planet Chatil. Add 2 power points to starting total.
- 11-15 New experimental drug raises intelligence score by 10 points. There are side effects: your teeth fall out. Reduce charisma by 03 points.
- 16-20 Training under Oda of Katrel. You learned an extra second energy bracket power.
- 21-25 Neural-synapse dysfunctions. All powers have a 05% chance of failing when "generated".
- 26-30 Early dismissal by your Mentor. Subtract 1 known power from starting total.
- 31-35 Your mind is highly resistant to mental attack forms. Raise SMR vs mental attacks by 10 points.
- 36-40 Your Mentor believed in power of mind at the expense of the body. Add 07 points to intelligence. Subtract 10 points of constitution
- 41-50 Rest time required to restore body to full strength for "generation" is halved.
- 51-55 Lack of concentration under combat situations. There is a 10% chance of "generation" failure.
- 56-60 Rest time required for power generation is doubled.
- 61-65 Mental strain when generating power. You have a 05% chance of passing out.
- 66-68 You were taught two, 3 energy point powers during rudimentary instruction.
- 69-70 An important message awaits you on Deldan 3.
- 71-72 A stranger has approached you. He tells you that the key to your future will be found on the Planet of Doom.
- 73-75 A special power coil was surgically implanted in the base of your cerebrum. Output power of all powers is double normal strength.
- 76-80 Seek out your Mentor. He has another power to train you in. (The new power costs nothing, but getting there does).
- 81-83 You're partially blind, but have developed your powers to their fullest potential. Add 5 power points. Subtract 50 from sighting checks.

- 84-85 You've been banned from "generating" by the Alliance for some past criminal act. All future powers to be learned cost triple normal. Conviction is punishable by Death.
- 86-88 You have been chosen to be your Mentor's disciple.
- 89-90 Accident caused brain damage. Reduce intelligence score by 25 points.
- 91-93 Selected for training at the renowned Releasement Center, on the Red Moon Xiarg orbiting the planet Katreel. Double all starting energy points.
- 94-95 Your mentor has given you a secret item. He says that it has special powers, but he won't tell you what they are.
- 96-98 Malignant brain tumor. The doctor gives you 2 months to live.
- 99-100 Trained to be your Mentor's disciple. Begin the game with 5 power points, instead of only 1. Double the amount of initial learned matrices.

### SPY FORTUNE TABLE

- 01-05 Expert training in forgery. Begin the game at 3rd level of proficiency.
- 06-10 Expert training in cryptography. Begin the game at 3rd level of proficiency.
- 11-15 Galactic Police are searching for you for questioning.
- 16-20 A contract is out on you. Two unsuccessful attempts have already been made on your life.
- 21-25 You have a contact in the Galactic Police.
- 26-30 Badly wounded during a botched operation. Reduce agility by 15 points.
- 31-35 The enemy tortured you for information and poked your eye out. Reduce sighting checks by -30.
- 36-40 You received 10,000cr for a successful assassination.
- 41-45 Poison almost killed you. Reduce constitution by 10 points and SMR vs poison by 05 points.
- 46-50 Blacklisted as an informant. Little chance of gaining employment.
- 51-55 Master of disguise. Take 3 levels of disguise.
- 56-60 Escape artist. Take 5 levels of escape.
- 61-65 Mental torture victim. Reduce intelligence by 10 points and SMR vs Mental attacks by 15 points.
- 66-70 Rebel agent. Receive 800cr a month into a secret account.
- 71-73 Shot while escaping. The bullet lodged in your spine. The operation to repair the damage was only partially successful. You have no sensation in your left arm.
- 74-75 The boss gave you a set of gold lock picks. They are professional quality.
- 76-77 Someone has turned you in as a double agent. At least three contracts have been put out on your life.
- 78-80 You successfully laundered 25,000cr worth of government bonds.
- 81-83 Someone put a slow acting poison in your food. You have determined its type. There is no known cure. You have about 1 month to find one.
- 84-85 Many contacts throughout the Core Worlds.
- 86-87 Blackmail attempt was successful. Collect 5000cr.
- 88-90 Wanted by the Alliance for treason against the State.
- 91-92 The Rebels offer you a position as a double agent. If you accept, collect 10,000cr now and wait for further instructions.
- 93-95 Trained at Mzanchia School of the Secret. Take 15 points worth of espionage skills.
- 96-98 Tortured to the brink of death when rescued. Permanent body damage. Reduce all vital statistics by 2d10.
- 99-100 You stumbled upon a secret cache. There are 50,000cr worth of credit chits. You can keep them or turn them into the Network.

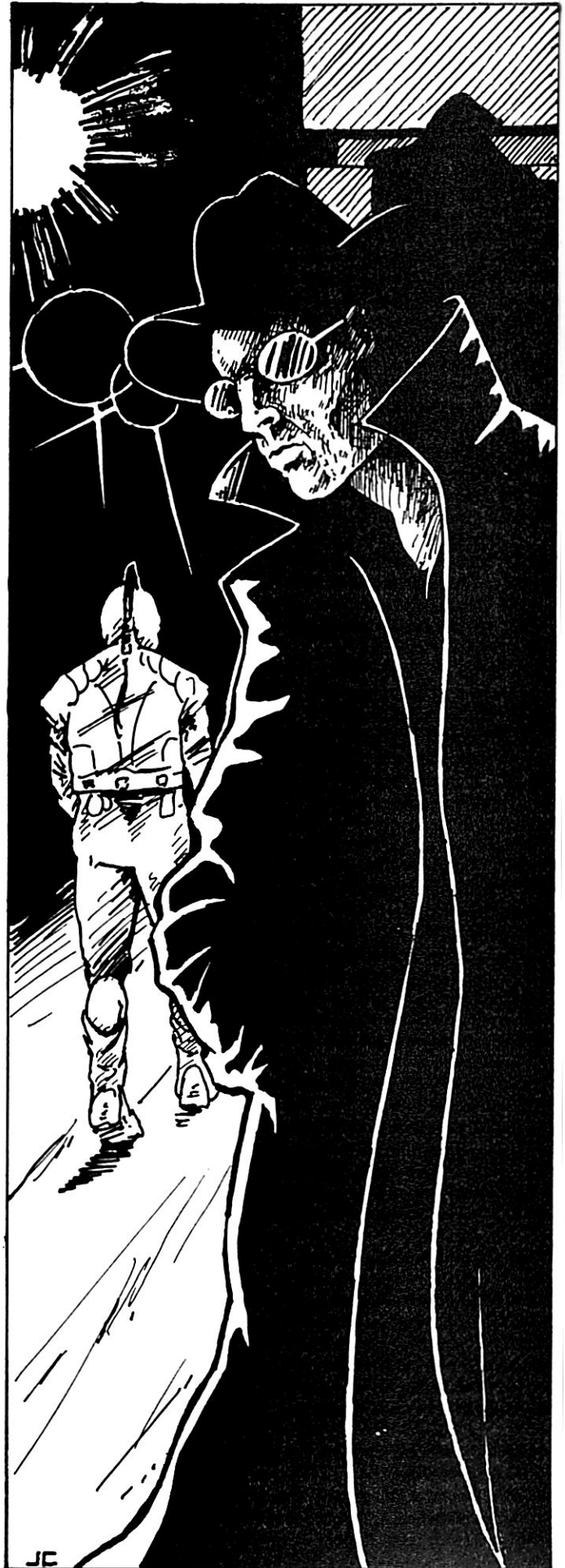

## OCCUPATIONAL SKILLS

Most characters choose 50 points worth of occupational and physical skills at the beginning of the game. The occupational skills denote those things which a character has been trained in or learned during his or her lifetime. Physical skills are athletic areas of training.

Characters are free to choose any combination of skills that they wish. Characters may begin the game with no more than 3 levels in any one skill, above and beyond any skill levels that the race begins the game with. Exception: Humans may start the game with up to 5 levels in a non-weapons skill.

It is the belief of this author that player characters should group the majority of their skill points into one basic occupational field, overlapping skills with other player characters so that if one character should get killed, there is a backup in the party (We all know that this would never happen). This way the party is still capable of functioning if someone is lost or incapacitated. PCs should spend about 20-30 points in one field, and use the remaining points as they see fit.

Certain races have occupational limitations. Since Pythons never developed space travel, why would they learn how to pilot spaceships? Player characters can ignore these limitations and train outside their fields at double the normal point cost.

Choosing occupational skills is explained as follows: A character picks Computers as his primary occupational field. He takes 2 levels in Bypass, 3 levels in Defeat Security, 3 in Programming, 3 in Operation, and 1 in Systems Repair. Each level in Bypass costs 3 points. Each level of Defeat Security costs 4, and so on. To determine the amount of proficiency points used,  $((3 \times 2 = 6) + (4 \times 4 = 16) + (3 \times 2 = 6) + (3 \times 1 = 3) + (1 \times 6 = 6)) = 37$ .

### STARTING PROFICIENCY POINTS

Chatilian:	35	Mutzachan:	35
Cizerack:	50	Orion Rogue:	60
Eridani:	40	Phentari:	40
Gen-Human:	55	Python:	50
Human:	70	Ram Python:	50
Mazian:	50	Zen Rigeln:	40

### OCCUPATIONAL PROFICIENCY

Naturally, a skilled character is able to perform a task with a much greater chance of success than one who isn't skilled. One level of proficiency in a specific skill indicates that the character is basically competent in all general tasks related to that particular field. As you increase your proficiency in a given skill, you gain additional modifiers to the dice rolls when determining chance of success. The base chance to succeed at skill use is 50%. Each level of skill adds +10% to this chance, except for weapon skills, which will be covered later. The task you are attempting will be assigned a difficulty level by the Battle Master. A level one task is easy; a level 10 task is hard; and a level 20 task is hero stuff. Each level of difficulty imposes a -10% penalty to your chance to perform the skill. A further modifier to your chance to perform a skill is the SB (skill bonus) of the attribute that skill is based on. The table below will tell you which SB to use. Whatever the final number is after adding and subtracting all modifiers, that is your chance to perform the job. If your modified total is above 100, roll anyway, because 100 always fails. If your score is below 0, don't be discouraged, because a 01 always succeeds.

**Example 1:** Fredd is attempting to defeat a 4th level computer security program. The task difficulty rating for a 4th level program is 40%. Fredd has 3 levels of Defeat Security (computers), which gives him a +30. Defeat Security is an I.Q. based skill, and Fredd's I.Q. of 32 gives him a -25% penalty. So, base chance of 50, plus skill of 30, plus skill bonus of -25, minus difficulty of 40, yields 15%  $(50 + 30 = 80; 80 - 25 = 55; 55 - 40 = 15)$ . So, Fredd has a 15% chance to defeat the security program. I guess Ram Pythons shouldn't play with computers.

**Example 2:** Fredd the Python still has 3 levels of Defeat Security. He is (for some strange reason) trying to defeat a 20th level system. Fredd has a +30 to the dice roll. The difficulty rating for attempting to defeat a 20th level system is -200. Fredd is still dumb as a rock, and receives a -25 skill bonus for I.Q. checks. His chance to break the system is  $50 + 30 - 200 - 25$ , which is equal to -145. Fredd needs to roll -145 or less on percentile dice to complete the job. That's not possible. However, a roll of 01 always succeeds. Fredd does not roll 01. The system detects the intrusion, fires a blast from an Omega cannon, and reduces poor Fredd to carbon atoms.

### PRIMARY OCCUPATIONAL SKILLS

Whenever a character has 25 or more skill points in a general field, he or she is considered to have learned a primary occupational skill. A primary occupational skill is a prerequisite for obtaining gainful employment. A character can ask for up to 40,000 credits per year as salary, if he has the right primary occupation. This is somewhat flexible, and is governed by demand for services, and the field he is in.

**Note:** The "Weapons" and "Gunnery" fields are considered part of the Military field. The "Security Systems" field is considered part of the Espionage field.

### SECONDARY OCCUPATIONAL SKILLS

A character who has a minimum of 15 points in any occupational field is considered to have a secondary occupation. A secondary occupation doesn't warrant the same pay that a primary does, but allows the character to obtain entry level positions in a given field area. A secondary occupation means you won't have to flip burgers at the local SpaceBurger if you get fired from your primary job.

### EXPERTISE IN A FIELD

To obtain expertise in any general field of study, a character must have skills worth a minimum of 40 points in the various subskills within the field. A character pays 1 point less for skills in a field when he attains expertise in that field. A character can become an expert at any time during his adventuring life, as long as he has accumulated a total of 40 points worth of skills in the field from somewhere along the way. If the cost of a skill is 1, it does not become 0, rather it is reduced to 0.5 points per level. **Note:** This does not apply to Weapon or Gunnery skills.

**Example:** Fredd the Python has obtained expertise in the field of Science (this is very difficult to believe, but it is possible.) Fredd wants to learn a new level of Physics. Normally, a level of Physics costs 5 proficiency points, but because Fredd is an expert, he only pays 4 points for the next level.

### MASTERY IN A FIELD

Once a character has accumulated 100 points or more skill points in any general field, then he has attained mastery in that field. Masters pay 2 points less than normal per level of proficiency. A master must study for only 1/2 the stated time to learn the next level of a skill. This represents the ability of an individual to teach himself, once he has mastered the fundamentals. Mastery in a field also brings a lot of recognition (and money). Masters in a field are often recognized by other people in the field, and their ideas and knowledge are often sought after. As stated above, if the -2 would take a skill below 1 point per level, the cost is reduced to 0.5 points per level. **Note:** This does not apply to Weapon or Gunnery skills.

### DEFAULTS

Some skills yield a default. This means that after a certain level of proficiency in one skill has been attained, a level of proficiency is bestowed in some other related subskill. Defaults are listed in the skill description. Default skill levels do NOT add their points towards totals for mastery or expertise.

### TIME TO PERFORM A TASK

Normally, it takes 5 minutes per level of difficulty to perform a task. Thus, a 5th level task would take approximately 25 minutes to complete. Each level of skill the character has over the difficulty level of the task reduces the time by 3 minutes. So the same level 5 task, performed by someone with level 7 skill, would take 25-6 or 19 minutes. There are circumstance modifiers that the BM will apply as he sees fit. Some skills require only seconds to perform while others can take hours. Situations will be adjudicated by the Battle Master.

### TIME TO LEARN NEW LEVELS OF PROFICIENCY

It takes time to learn a new level of skill in a given field. One has to be tutored formally in most cases. In some instances though, characters may learn new levels of proficiency while in the field. Discuss this with the BM as it applies. The time it takes to learn a new level of proficiency is listed in the skill description.

### PROFICIENCY COST

This denotes the number of skill points that a character must expend before he can gain a new level of skill proficiency. This is listed under SC in the skills description.

### LEVELS OF DIFFICULTY

The difficulty rating denotes the modifier to the base chance for success to perform a task. The relative difficulty of tasks increases by increments of ten per level. There are exceptions to this rule such as weapon skills. Below are listed examples of levels of difficulty.

Level	Modifier	Example
1	-10	Simple tasks like turning the machine on.
3	-30	Routine operations, like a simple program.
5	-50	Average difficulty.
7	-70	Difficult work: Tricky stuff here.
10	-100	Real challenge: Better be good.
12	-120	How much did you say I was getting paid?
15	-150	Wow am I good!
17	-170	You can brag about this stuff.
18	-180	Easy stuff like hacking into NORAD.
20	-200	Going to try for the Nobel Prize?
22	-220	World record type stuff.
24	-240	The ultimate challenge.
25	-250	Impossible for a mere mortal.

**Non-proficient characters may still attempt to perform a task. They automatically incur a -40 penalty modifier to the difficulty rating.**

**Example:** Phil the Phentari is torturing poor Henry the Mutzachan for information on Fredd the Pythons whereabouts. Henry is an easy mark so the BM rules this is a level 1 interrogation check. Phil has no proficiency in this skill. Because he is not proficient, he must subtract 40 from the base chance of 50%. He has a skill bonus of +20% due to his I.Q. bonus. The modifier for a level 1 task is -10%. Therefore he still has a 20% chance to succeed at the skill. Poor Henry...

### USING MULTIPLE SKILLS

Characters may sometimes need to perform two or more skills at the same time. For example, if the party is trying to concoct an antidote for a poison, the Battle Master might rule that this involves Poisons (Medical Treatment) skill, and Chemistry (Sciences). The way to go about this is to add up all the appropriate skill levels, and then divide by the number of skills involved. The number obtained is the effective skill level. If more than one character is working together, add up the skill levels and divide by the number of skills involved, plus one per additional character. Round fractions down. This is because it is often more difficult to work with someone than it is to do it by yourself.

**Example 1:** A Zen Rigel is trying to brew an antidote for some poison which had been dipped on arrows and fired at the party. He has Poisons level 5 and Chemistry level 3.  $5 + 3 = 8$ ;  $8 / 2 = 4$ . His effective skill level is 4 for this skill check.

**Example 2:** The Zen Rigel doesn't have Chemistry skill, only Poisons. A Gen-Human in the party does have Chemistry skill. The Zen has Poisons level 5. The Gen-Human has Chemistry level 1. There are two characters involved, so the divisor is  $2 + 1 = 3$ .  $5 + 1 = 6$ ;  $6 / 3 = 2$ . For the purposes of this skill check, the skill level is 2.

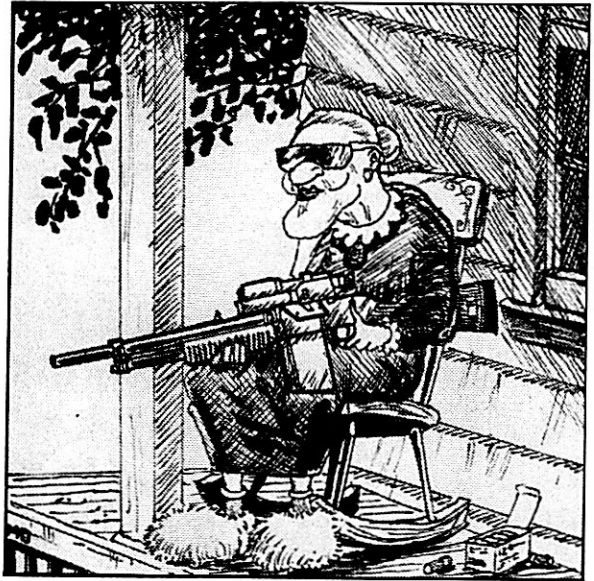

### RACIAL LIMITATIONS

1. Python Lizards and Ram Pythons can choose proficiency in piloting fighter aircraft. They may not, however, pilot deep space craft. Furthermore, the use of beam weapons is possible, but should be reconsidered since Pythons can't see very far.
2. Mazians can be proficient in all fields except those which are weapon oriented. The Mazian idea of combat is oozing over each other.
3. Zen Rigel and Tza Zen may be proficient in all fields except Deep Space and Piloting.
4. Mutzachan characters may not use energy weapons, unless they are specially insulated (cost 1.5 times as much).
5. Chatilian characters can be proficient in all fields except Robotics. They can choose the Identify Robots skill, however.
6. Eridani don't use Archaic Powder Weapons, because they are considered inferior weapons to be used only by the mudig (peasants).
7. Gen-Humans, Humans, Orion Rogues, Cizerack, and Phentari have no racial restrictions.
8. These restrictions can be alleviated by paying two times the skill cost.

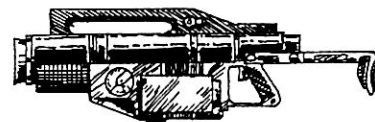

## KEY TO OCCUPATIONAL SKILLS TABLE

SC: The cost in proficiency points to gain a new level of the skill.

L: The maximum level of proficiency attainable in this field.

T: Time needed to learn another level in the given field.

\$: The amount of money (in hundreds of credits) that an individual must pay to learn a level of the skill.

PS: The primary statistic represents the most important vital statistic to perform that skill. Skill bonuses are added to or subtracted from the chance to perform the task. (See vital statistics tables for the skill bonuses). Some skills don't have primary statistics.

JA: The job availability is the percentage chance to find a job per level of experience. The percentages are cumulative.

M: Management Level. The number of levels required before the character can manage or train others.

JS: This denotes the relative job security on a scale of 1 to 10 (higher = better).

BC: Represents the chance to pick up business contacts, per level of proficiency.

The number at the top of each field represents the amount of money that a character may ask for when seeking employment. This assumes that the character has a primary occupation in the given field. Those individuals with secondary occupational skills may ask for 1/2 to 2/3 of the listed amount. SEE SALARY ON PAGE 225.

## PHYSICAL SKILLS

	SC	L	T	\$	PS	JA	M	JS	BC
Acrobatics	5	20	3mo	10	AG	20	10	7	0
Agility	3	7	1mo	50	-	-	-	-	-
Alertness	5	3	1wk	10	-	-	-	-	-
Body Equilibrium	7	10	1yr	90	-	-	9	-	-
Body Points	3	6	2wk	50	-	-	-	-	-
Breathing	1	10	2da	1	-	-	-	-	-
Climbing	1	25	2wk	2	AG	2	5	3	0
Deep Sleep	1	12	1wk	5	-	-	-	-	-
Hand to Hand	2	25	3wk	4	AG	-	10	-	-
Archaic Hand Weapon	2	25	2wk	2	AG	-	10	-	-
Stealth	1	18	1wk	1.5	AG	-	12	-	-
Strength	3	7	1mo	2.5	-	-	-	-	-
Swimming	1	6	var	.25	CN	-	2	-	-

## OCCUPATIONAL SKILLS

## Alien Technologies

60,000

	SC	L	T	\$	PS	JA	M	JS	BC
Alien Technologies	10	25	6mo	50	IQ	25	6	10	15

## Arts and Crafts

15,000

	SC	L	T	\$	PS	JA	M	JS	BC
*Poet	1	25	1mo	1	IQ	02	10	1	01
*Singer	1	25	2wk	.5	-	04	10	2	05
*Bard	1	25	2wk	1	CH	02	10	1	03
*Calligrapher	1	25	1mo	1.5	MD	04	8	2	01
Graphics	3	25	2mo	3.5	IQ	07	7	3	01
Painter	2	25	2mo	2	MD	05	10	2	02
Musician	2	25	1mo	1.5	MD	04	10	3	03
Potter	2	25	1mo	2	MD	03	20	4	01

## Communications

15,000

	SC	L	T	\$	PS	JA	M	JS	BC
Hand Radio	1	25	1wk	.5	IQ	-	5	-	-
Base Station	2	25	1mo	2	IQ	01	5	2	01
Interplanetary	4	25	6wk	4	IQ	03	5	8	02
Interstellar	5	25	2mo	6	IQ	07	5	8	02
Repair, Basic	3	25	3mo	6	IQ	14	7	8	02
Repair, Space	6	25	4mo	8	MD	20	5	8	03

## Computers

25,000

	SC	L	T	\$	PS	JA	M	JS	BC
Bypass	3	25	2mo	3	IQ	10	9	7	03
Defeat Security Operation	4	25	2mo	4	IQ	15	9	7	03
Programming	2	25	2wk	2	IQ	07	5	4	01
Repair Systems	3	25	2mo	2	IQ	07	10	6	02
	6	25	5mo	8	MD	20	6	9	03

## Cybernetics

38,000

	SC	L	T	\$	PS	JA	M	JS	BC
Engineering	7	25	6mo	22	IQ	30	6	9	10
Installation	5	25	3mo	4	MD	17	7	9	03
Manufacturing	4	25	3mo	10	MD	20	6	9	03
Repair	7	25	5mo	12	MD	40	6	10	03

## Deep Space Operations

40,000

	SC	L	T	\$	PS	JA	M	JS	BC
Astrocartography	3	25	2mo	2	IQ	05	8	4	01
Construction	5	25	4mo	90	MD	35	5	4	02
Decontaminate	3	25	2mo	4	IQ	10	7	5	02
Emergency Damage Con.	5	25	4mo	40	IQ	15	10	4	02
EVM	4	25	2mo	20	AG	-	7	-	-
Identify Vessels	1	25	1wk	2	IQ	-	15	-	-
Mining (asteroids)	7	25	3mo	20	IQ	30	6	6	06
Navigation	4	25	3mo	20	IQ	25	8	6	05
Remote Piloting	5	25	4mo	30	IQ	18	6	6	02
Salvage (space)	8	25	4mo	90	IQ	35	5	9	08
Surveyor	4	25	2mo	20	IQ	15	8	8	06
Traffic Controller	5	25	2mo	15	IQ	20	6	6	02

## Engineering

32,000

	SC	L	T	\$	PS	JA	M	JS	BC
Architectural	5	25	3mo	6	IQ	17	8	7	03
Civil	5	25	3mo	6	IQ	17	8	7	03
Cybernetic	7	25	6mo	22	IQ	30	6	9	10
Electrical	6	25	4mo	8	IQ	17	8	7	03
Hydraulic	5	25	4mo	6	IQ	17	8	7	03
Ionization	9	25	7mo	50	IQ	30	6	7	15
Mechanical	6	25	4mo	6	IQ	17	8	7	03
Nuclear	7	25	5mo	12	IQ	30	6	7	10
Robotics	7	25	6mo	20	IQ	30	6	7	10

## Espionage

24,000

	SC	L	T	\$	PS	JA	M	JS	BC
Bribery	2	25	1wk	2	CH	-	8	-	05
Camouflage	1	25	4da	1	IQ	-	5	-	-
Concealment	1	25	2da	.5	IQ	-	5	-	-
Detect Concealment	1	25	1wk	1	IQ	-	5	-	-
Disguise	3	25	2mo	5	IQ	-	10	-	08
Escape	3	25	2mo	5	AG	-	10	-	-
Forgery	5	25	4mo	8	MD	10	10	1	20
Impersonation	4	25	4mo	8	IQ	05	10	1	12
Infiltration	2	25	1mo	5	IQ	04	5	2	03
Intelligence	5	25	4mo	10	IQ	20	10	3	15
Interrogation	4	25	1mo	4	IQ	10	10	2	08
Pick Locks	3	25	2mo	3	MD	07	7	4	04
Pick Pockets	2	25	1mo	2	MD	-	5	-	01

## Journeyman Skills

16,000

	SC	L	T	\$	PS	JA	M	JS	BC
Bartering	1	25	2mo	2	-	07	10	3	10
Carpentry	2	25	1mo	2	MD	25	8	3	02
Cook	2	25	1mo	2	IN	15	8	5	05
Electrician	3	25	1mo	4	MD	25	12	3	02
Electronics	4	25	2mo	5	IQ	30	12	4	04
Holo-Installer	2	25	2mo	2	MD	15	10	2	05
Mechanic	3	25	2mo	4	MD	25	6	4	04
Mining (planet)	5	25	3mo	6	IQ	20	7	7	03
Welder	4	25	1mo	6	IQ	15	8	3	02

Occupational Skills

Medical Treatment				25,000				
SC	L	T	\$	PS	JA	M	JS	BC
Basic	1	25	1wk	.5	IQ	03	5	2 01
Decontaminate	3	25	2mo	4	IQ	10	7	5 02
Disease Diagnosis	3	25	3mo	4	IQ	12	10	5 03
Disease Control	4	25	3mo	6	IQ	15	8	6 03
Infections	1	25	1wk	6	IQ	03	12	4 05
Paramedic	4	25	1mo	5	MD	17	6	7 07
Poisons	1	25	1wk	6	IQ	04	12	4 07
Radiation	4	25	5mo	8	IQ	25	7	9 20
Surgery	7	25	7mo	12	MD	35	6	9 25

Military Skills				30,000				
SC	L	T	\$	PS	JA	M	JS	BC
Camouflage	1	25	4da	1	IQ	-	5	- -
Concealment	1	25	2da	.5	IQ	-	5	- -
Demolitions	3	25	2mo	6	IN	12	10	3 05
Detect Concealment	1	25	1wk	1	IQ	-	5	- -
Infiltration	2	25	1mo	5	IQ	04	5	2 03
Interrogation	4	25	1mo	4	IQ	10	10	5 08
Mapping	2	25	2mo	2	IQ	02	12	1 01
Military Leadership	2	5	5wk	6	-	-	5	- -
Mountain Climbing	2	25	2wk	2	ST	02	10	2 01
Navigation (land)	2	25	2wk	1.5	IQ	10	7	5 05
Repelling	1	25	2wk	1	AG	-	6	- -
Scouting	2	25	2wk	1.5	IN	05	10	4 02
SCUBA	2	25	3wk	2	AG	07	10	6 05
Set Traps	2	25	1mo	2	MD	-	5	- -
Sighting	1	10	1wk	1	-	-	1	- -
Spelunking	2	25	3wk	2	AG	15	5	4 05
Survival (by environs)	2	25	2wk	2	IN	10	10	2 01
Survival (urban)	2	25	2wk	1	IN	02	10	3 01
Survival (emergency)	3	25	4wk	5	IN	10	10	3 05
Throwing	1	25	1wk	-	ST	-	-	- -
Tracking	2	25	2mo	2	IN	05	7	3 01

Robotics				45,000				
SC	L	T	\$	PS	JA	M	JS	BC
Activate/Deactivate	3	25	3mo	3	IQ	10	10	3 04
Engineering	7	25	6mo	20	IQ	30	6	7 10
Function Alteration	4	25	4mo	4	IQ	12	8	3 04
Identification	1	25	1wk	.5	IQ	-	10	- -
Modification	5	25	5mo	6	IQ	07	7	6 10
Repair	6	25	4mo	8	MD	15	7	6 12

Sciences				30,000				
SC	L	T	\$	PS	JA	M	JS	BC
Anthropology	2	25	2mo	2	IQ	08	10	6 05
Archaeology	2	25	2mo	2	IQ	07	10	8 06
Biology	3	25	3mo	3	IQ	15	9	8 06
Botany	3	25	3mo	3	IQ	15	9	8 06
Chemistry	3	25	3mo	3	IQ	07	9	8 06
Cryptography	4	25	4mo	6	IQ	20	7	7 08
Forensics	4	25	4mo	6	IQ	20	7	7 07
Gemology	3	25	3mo	3	IQ	15	10	7 04
Geology	3	25	3mo	5	IQ	10	7	7 05
Physics	5	25	5mo	8	IQ	20	7	8 10
Theology	2	25	2mo	2	IQ	05	10	9 05

Security Systems				See ESPIONAGE				
SC	L	T	\$	PS	JA	M	JS	BC
Activate/Deactivate	4	25	3mo	3	MD	10	9	7 04
Detect	3	25	3mo	3	IQ	-	5	- -
Operate	2	25	2mo	2	IQ	04	5	6 04
Pick Locks	3	25	2mo	3	MD	07	7	4 04
Systems Design	6	25	5mo	8	IQ	20	8	8 10

Vehicles				25,000				
SC	L	T	\$	PS	JA	M	JS	BC
Automobile	1	25	2wk	1	MD	05	3	3 00
Fighter	5	25	2mo	10	MD	20	8	9 10
Fighter(DS)	6	25	3mo	15	MD	25	7	10 10
Hopper	3	25	3wk	3	MD	02	5	6 01
Remote Piloting	5	25	2mo	30	IQ	35	5	9 08
Skimmer	2	25	3wk	2	MD	08	5	3 01
Spacecraft	6	25	4mo	20	MD	25	10	10 12
Tank	3	25	1mo	4	MD	-	5	- -
Transcruiser	4	25	1mo	5	MD	07	10	5 05

Gunnery				See MILITARY				
SC	L	T	\$	PS	JA	M	JS	BC
Powder	3	25	2mo	8	MD	-	10	- -
Beam	4	25	3mo	10	MD	-	10	- -
Energy Weapon	4	25	4mo	15	MD	-	10	- -
Pulse	5	25	4mo	15	MD	-	10	- -
Omega	5	25	4mo	25	MD	-	10	- -
Particle	6	25	4mo	18	MD	-	10	- -
Missile	5	25	4mo	30	MD	-	10	- -
Repair	BY WEAPON TYPE			MD	-	10	- -	- -

Weapons				See MILITARY				
SC	L	T	\$	PS	JA	M	JS	BC
Archaic Hand	2	25	1wk	5	AG	-	10	- -
Archaic Powder	2	25	2wk	8	MD	-	10	- -
Beam	3	25	2wk	10	MD	-	10	- -
Energy Weapons	3	25	2wk	10	MD	-	10	- -
Direct Fire	3	25	1wk	12	MD	-	10	- -
Indirect Fire	3	25	1wk	12	IN	-	10	- -
Omega	4	25	1mo	20	MD	-	10	- -
Particle	3	25	1mo	10	MD	-	10	- -
Pulse	4	25	3wk	12	MD	-	10	- -
Repair (weapon)	BY WEAPON TYPE			MD	-	10	- -	- -
Repair (armor)	4	25	2mo	15	MD	25	10	7 05
Throwing	1	25	1wk	-	ST	-	-	- -

Miscellaneous				15,000-50,000				
SC	L	T	\$	PS	JA	M	JS	BC
Accounting	4	25	3mo	2	IQ	10	10	8 05
Administration	5	25	4mo	5	IQ	10	10	9 10
Business Management	4	25	3mo	3	IQ	10	10	6 12
Etiquette	3	25	1mo	1	CH	05	8	2 04
Gambling	2	25	1mo	5	IN	10	10	2 10
General Knowledge	1	25	2wk	-	IQ	-	-	- -
Law	4	25	3mo	2.5	IQ	10	10	6 07
Linguistics	4	25	3mo	2	IQ	07	9	6 07
LMM	2	25	1mo	1	IQ	05	10	7 10
Matrix Manipulation	4	25	3mo	20	IQ	-	10	- -
Mazian Shape Change	3	25	2mo	-	MD	-	-	- -
Persuasion	1	10	1wk	1	CH	-	6	- -
Street Smart	2	20	2wk	-	IN	-	-	- -
Survival (urban)	2	25	1wk	1	IN	02	10	3 01

Languages				16,000				
SC	L	T	\$	PS	JA	M	JS	BC
Any	1	3	4mo	5	IQ	03	10	6 07

\* One can obtain a primary occupational skill in these areas by expending only 15 points.

NOTE!!! A roll of 100 on percentile dice results in a failure to perform the task. A roll of 01 on percentile dice results in completion of the task, regardless of modifiers.





## PHYSICAL SKILLS

**Acrobatics:** Any character with a minimum strength of 45, an intelligence score of 60, and an agility score of 65 can be an acrobat. The primary abilities of an acrobat are jumping, tumbling, tightrope walking, vaulting and dodging.

Tightrope walking entails movement across wires and along narrow ledges. This ability allows a character to ascend a rope or a beam up to about a 20 degree incline, without falling. A player may travel up to 50m in this mode per attempt, with a movement rate of 20m per minute. Wind conditions and slipperiness have a direct effect on tightrope walking.

Tumbling is the ability of a character to break his fall, in order to avoid damage. Proficient characters can fall 0.5m per level of proficiency. A character who has 10 levels of acrobatics could fall 5m without getting hurt. Any character may attempt a fall from a height higher than is normally safe. This is quite dangerous to say the least. The chance of success decreases at a rate of 10% per meter of height above the character's normal safe height.

**Example:** Henry the Mutzachan is being chased by Fredd the Python. Henry decides to jump from a 10m cliff, in order to avoid certain death. Henry is a 7th level Acrobatics specialist. His chance of being hurt equals:  $(10 - (7 \times 5) \times 10) = 65\%$ . So he needs to roll a 35 or less to live. Henry jumps and rolls a 15 on percentile dice. Henry is safe. Fredd, caught up in his rage, jumps to follow and falls, making a mess on the ground below. SC: 5

**Agility:** Players may wish to improve their agility. To do so they may train by practicing gymnastics, dance, or combat. To train, one must practice at least two hours each day. Each level of training improves agility by +03%. Using this method costs the listed number of proficiency points, but is free. Other means of improving one's agility include pharmaceutical means. There are drugs on the market that chemically push the body to it's peak. Each injection costs 5000cr and improves agility by +03%. The drug is safe but rare, and there is a maximum of 2 safe injections per month. Cheaper drugs may be taken but they are unsafe and often illegal. Note that using these drugs does not cost skill points, but counts as a skill level due to the fact that there is a limit to how much agility can be increased. SC: 3

**Alertness:** Alert characters gain modifiers to initiative rolls at a rate of -1 per level of skill. SC: 5

**Body Equilibrium:** A strange, mysterious ability taught by the Buddon Priests. One learns to harness the internal self and after years of training can do the following:

- 1st level: Hold one's breath for 2 minutes. This increases by 15 seconds per level.
- 2nd Level: Stop blood loss for up to 20 minutes, if conscious.
- 3rd Level: Feign Death: Slow down all bodily functions until they appear to cease. Can be held up to 4 hours + 1 hour per level.
- 4th Level: Death's Door increased by 1 point. -1 to initiative rolls. +10 to mental SMRs.
- 5th Level: Remain conscious down to -4 body points.
- 6th Level: Death's Door is increased by 2 additional points. Personal skin threshold of 1.
- 7th Level: Remain conscious down to -6 body points. -2 to initiative rolls.
- 8th Level: Additional mental SMR bonus of +10
- 9th Level: Death's Door increased by 2 additional points. Personal skin threshold of 2.
- 10th Level: Soul Flight: The individual may leave his body and travel about. He can't be seen or detected by any normal means. He may communicate with spirits or other entities that he may encounter while in Soul Flight. Movement out of body is 1/2 normal.

SC: 7

**Body Points:** A character can have his body points raised through the use of body enhancement drugs. Each level of body points skill adds body points equal to 1/2 of your size class (or 3 for Cizerack). Characters must spend 2 weeks at the proper medical facility to receive the additional points. Player characters should note that the cost of such drugs is expensive and limited by artificial means. PCs can find natural means to increase body points. A player who receives additional body points in this manner also gains a +03% increase to system shock and resurrection rolls and a +02% increase on all SMRs except mental. As with increasing agility, using the drugs costs money but not proficiency points, while natural methods cost proficiency points but no money. SC: 3

**Breathing:** Proficiency in breathing bestows the ability to hold one's breath while exposed to a contaminated environment or while underwater. A normal character can hold his breath for about 1 minute while standing still and for half that if running, swimming, or exerting a large amount of energy. Each level of proficiency adds 30 seconds to the length of time that you can hold your breath. SC: 1

**Example:** A character with 4 levels of proficiency in breathing can hold his or her breath for 3 minutes while standing still and 1.5 minutes while swimming underwater.

**Climbing:** Allows a character to climb ropes and vertical surfaces with an increased chance of success. A first level character has a 100% chance of successfully climbing all ropes and ladders without falling. He climbs at the rate of 10m per round. When climbing other surfaces difficulty may increase. Characters with any encumbrance whatsoever incur a 15% penalty per level of encumbrance when climbing. PCs may purchase climbing equipment that can reduce the risk of falling. SC: 1

**Deep Sleep:** By deep internal relaxation, an individual learns to control his sleep patterns. Characters can quickly move through the initial levels of sleep into deep sleep. Normal characters need a minimum of 8 hours sleep. For each level of proficiency in Deep Sleep, the individual shortens the required sleep time by 30 minutes. SC: 1

**Hand to Hand Combat:** Hand to Hand combat denotes close combat skills, using hands or knives. Proficiency can only be raised by intense training at a military school or by a certified expert in the field. Proficiency provides the character with added bonuses to hit when attempting to strike an opponent, and an additional bonus when resolving damage, as trained individuals are adept at striking vital areas. Trained hand to hand combat students may also attempt to disarm opponents. Characters with high levels of hand to hand skill can also make multiple attacks in one melee segment. The number of attacks is equal to 1 additional per 3 full levels of skill. So, a human with level 1 would get 2 attacks, while one with level 6 would be able to make 4 attacks. The following table lists the bonuses gained when engaging in hand to hand combat for the first 12 levels of skill. SC: 2

	HIT	DAM	PERCENT	NUMBER OF
LEVEL	BONUS	ADJ	TO DISARM	ATTACKS
1	+04	0	05	+0
2	+08	+1	10	+0
3	+12	+1	15	+1
4	+16	+1	20	+1
5	+20	+2	25	+1
6	+24	+2	30	+2
7	+28	+2	35	+2
8	+32	+3	40	+2
9	+36	+3	45	+3
10	+40	+3	50	+3
11	+44	+4	55	+3
12	+48	+4	60	+4

**Non-proficient characters have a 01% chance to disarm an opponent. This skill counts toward a Military occupation.**

**Archaic Hand Weapons:** The use of swords, clubs, and bows is covered by this skill. Unlike other skills, characters must specify what type of weapons they have skill in, such as Sword, Bow, Crossbow, etc. The reason for this is that archaic hand weapons vary greatly in size and fighting style. All bonuses are identical to those gained by Hand to Hand skill (above), including multiple attacks at high levels. Bows and crossbows do not gain additional attacks. SC: 2

**Stealth:** Stealth measures one's ability to move silently, hide in shadows, and avoid detection. PCs may train at a military reconnaissance school in order to become more proficient in this area, or they may train on their own. Characters must attend a reconnaissance school for a period of no less than 1 week per level of proficiency to be obtained.

Hiding in shadows entails movement in shadowy areas to avoid detection. Moving silently is self explanatory. Characters attempting to move silently must not be encumbered or carrying objects that would make noise. Avoiding detection measures the ability of a character to move in the open without being seen. This skill counts toward a Espionage occupation. SC: 1

**Strength:** Players may wish to increase their strength. To do so they train by lifting weights for one month per point of strength gained. Characters who choose to train alone must do a regimented workout of 2 hours a day. The character receives 03% increase in his or her strength statistic per level attained.

The only other safe way to become stronger is to take the drug Apititoxin. Apititoxin, an anabolic steroid, raises strength by 03% for each injection. An injection costs 5000cr and a maximum of 2 may be taken in any month. There are no residual side effects and no booster shot is required to maintain the condition. Use of this drug costs no proficiency points but still counts as a level of skill. There are cheaper steroids that can be taken but they are not safe and may cause serious health problems in the long run. SC: 3

**Swimming:** Proficient characters can swim great distances and run a reduced risk of drowning. A typical individual cannot swim. He risks a 10% chance of drowning for every 10m he swims. Non-proficient characters have no chance of saving drowning victims. Skilled characters may swim in dangerous waters. A person can swim farther by practicing every day for a specified period of time, as noted in the chart below. Note that this skill never allows characters to swim in armor. SC: 1

LEVEL	TIME	SKILLS	DISTANCE
1	1wk	a	200m
2	3wk	ab	400m
3	7wk	abc	800m
4	18wk	abcd	2000m
5	25wk	abcde	6,000m
6	35wk	abcde	12,000m

**A:** The character can tread water for 5 minutes. This increases by 5 minutes per level of proficiency.

**B:** The character can dive up to 8m and retrieve a 10kg object. The depth attainable increases by 2m per level.

**C:** The character is able to rescue other individuals with a 60% chance of success. This increases by 05% per level of proficiency.

**D:** The character is trained in lifesaving and can resuscitate drowning victims 55% of the time. This increases by 05% per level of proficiency.

**E:** The character is able to swim in dangerous waters with 80% chance of survival. This increase at a rate of 05% per level.

## OCCUPATIONAL SKILLS

### ALIEN TECHNOLOGIES

**Alien Tech:** This skill entails the use of alien instruments of technology. The character must use this skill in conjunction with the skill that corresponds to the action being undertaken. SC: 10

**Example:** A character with Alien Tech. level 4 and Operate Computers level 6 is trying to operate an alien computer system. His effective level is  $(4+6)/2$ , or 5.

### ARTS AND CRAFTS

**Poet:** The character can compose poetry. Proficient characters can write Haiku, free verse, etc. SC: 1

**Singer:** The character can sing. SC: 1

**Bard:** A Bard is a story teller, versed in Galactic mythology. The ability to tell a creative story increases with their skill. SC: 1

**Calligrapher:** The ability to create beautiful handwriting. Proficient characters are much sought after on Tech Level 1, 2, and 3 planets. SC: 1

**Graphics:** The individual is skilled at computer graphics. He knows how to use the computer to do visual and audible art work. Requires 1 level of computer operation. SC: 3

**Painter:** High levels of this skill provide a painter with the ability to create beautiful pieces of artwork, and he can then charge large sums of money for them. Painters are sought after mostly in tech level 2 or lower societies. SC: 2

**Musician:** A musician can sing or play an instrument. Each extra instrument costs 1 additional point to learn. Any character with 10 levels of proficiency in music is considered to have mastered the fundamentals and can then compose his own material. SC: 2

**Potter:** Pottery is admired by all the "civilized" races and is sold in all Tech societies. SC: 2

### COMMUNICATIONS

Radio skills add a +04% modifier per level of skill to radio checks.

**Hand Radio:** The character has knowledge of most hand radio units. He can attempt minor repairs on these items. SC: 1

**Base Station:** Base stations rigs are commonly found on land vehicles and in base camps. Proficiency bestows the knowledge of operating these units. SC: 2

**Interplanetary Com-link:** With this skill and the right equipment a person can communicate between planets. SC: 4

**Interstellar Com-Link:** Characters who are proficient on this piece of equipment can be hired as communications officers aboard spaceships. SC: 5

**Repair:** Characters can repair all types of communications equipment, except for the interplanetary and interstellar comlinks. SC: 3

**Repair (space):** Bestows the ability to repair interplanetary and interstellar comlinks. Characters must be able to use the radio. Personnel can seek employment at spaceports, starbases, and stargates. SC: 6

### COMPUTERS

**Bypass Security:** Proficiency in bypassing the security of computer systems provides the ability to circumvent the protective systems built into the computers. Security systems have defenses to prevent an illegal entrance through a "back door". Most will alert the owners to the breach in security. At the same time, they convince the intruder that he has gained access to prevent him from leaving the area. The intruder attempts to get around the security without tripping the alerting mechanisms. Each level of Bypass requires an equal level of Programming. SC: 3

## Occupational Skills

**Defeating Security:** Defeating a security system is different than bypassing one. Bypassing involves circumventing built in protective measures, while defeat security entails disabling the protective measures. One level of programming is required per level of defeat security. SC: 4

**Operation:** The character can operate a variety of computers. He has been trained in the use of a number of software packages and is capable of using systems, but can not necessarily program the computer. SC: 2

**Programming:** Proficiency in this area allows the individual to program different functions into a computer through the use of keyboard or voice printer. One level of Operations is required per level of Programming. SC: 3

**Repair Systems:** This skill is expensive to obtain, yet extremely useful. Proficient characters can fix systems on board a wide variety of machines, including tanks, spacecraft, robots, etc. In fact almost every device beyond tech 3 uses some sort of computer to facilitate system operations. SC: 6

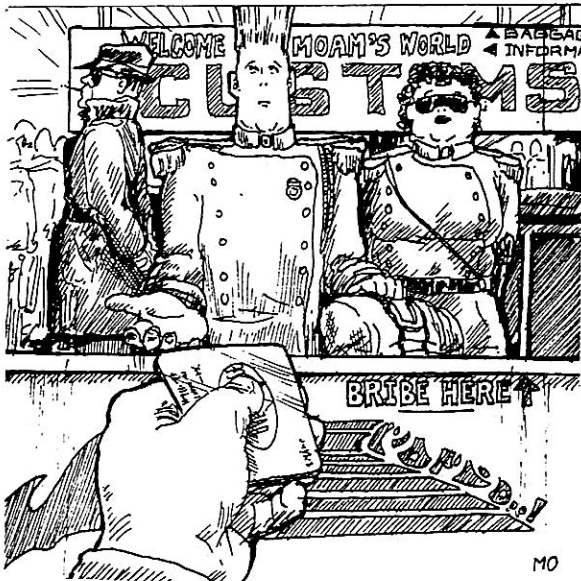

## CYBERNETICS

**Cybernetic Engineering:** Bestows the ability to design artificial attachments associated with bionics. A cybernetics engineer can design an artificial arm, leg, or eye. He is also capable of determining inherent defects in cybernetic equipment. Cybernetic design is different from robotics design; the mechanics are the same, but the applications are different. Requires 1 level of electrical and mechanical engineering. SC: 7

**Installation:** Characters must have a minimum of 2 levels of proficiency in Surgery before choosing this skill. It provides the character with the knowledge necessary to surgically attach cybernetic limbs. SC: 5

**Manufacturing:** Characters must have a minimum of 1 level of electrical and welding before taking this skill. Proficient individuals can produce cybernetic attachments in a factory environment; however, they can not design them. SC: 4

**Repair:** The repair of defective cybernetic limbs. It requires 2 levels of mechanical and electrical engineering and 1 level of Surgery as prerequisites. SC: 7

## DEEP SPACE OPERATIONS

**Astrocartography:** Individuals are able to map star systems. They are also capable of determining the presence of important galactic phenomena. Most importantly, proficient persons can chart the course of a starship. SC: 3

**Construction (space):** One can work on Galactic rig crews, erecting new structures in deep space. One must have a minimum of 3 levels of EVM in order to get into a construction program. SC: 5

**Decontaminate:** A MUST for characters who intend to explore uncharted planets. Proficient characters possess pertinent knowledge concerning quarantine, decontamination, and isolation procedures. SC: 3

**Emergency Damage Control:** This skill allows a character to take charge of emergency damage repair on a starship, especially during battles, when quick repairs can mean the difference between living or sucking vacuum. SC: 5

**EVM (Extra Vehicular Movement):** Allows characters to operate outside the spaceship. Individuals can spacewalk, operate space packs, and function in zero-gravity. SC: 4

**Identify Vessels:** The ability to identify space vessels. SC: 1

**Mining (Asteroids):** Characters with 5 levels of proficiency can gain employment on Mining Away Teams (MAT). It should be noted that asteroid mining is a very lucrative business. SC: 7

**Navigation:** This skill allows characters to plot a course in a ship's computer, and is vital to the operation of a starship. Only the very best starships have auto-navigation units, as these devices are incredibly expensive. SC: 4

**Remote Piloting:** Good to know. One can remote pilot vehicles from their position in orbit to ground units. Characters can also attempt to pilot vehicles from ground to space. This is much more difficult and incurs a minus 30% penalty to skill checks. SC: 5

**Salvage (Deep Space):** The highest paid skill of all the space professions. Dangerous, but worth it. Pay checks are often missed until the big catch is landed. Salvagers retrieve derelict space trash for recycling and sale. SC: 8

**Surveyor:** Trained personnel can provide an overview of a planet's climatography and geographical features. SC: 4

**Traffic Controller:** Directs incoming traffic at spaceports. One needs 4 levels to apply for a job. SC: 5

## ENGINEERING

**NOTE!!** All engineering skills require at least two levels of physics.

**Architectural:** Allows individuals to design structures such as bridges, buildings, starbases, domes, etc. An architect can determine whether or not a particular structure is sound. He also has a good knowledge of materials. SC: 5

**Civil Engineering:** A civil engineer is concerned with the building and maintenance of structures such as bridges and roads. SC: 5

**Cybernetic Engineering:** Bestows the ability to design artificial attachments associated with bionics. A cybernetics engineer can design an artificial arm, leg, or eye. He is also capable of determining inherent defects in cybernetic equipment. Cybernetic design is different from robotics design; the mechanics are the same, but the applications are different. Requires 1 levels of both electrical and mechanical engineering. SC: 7

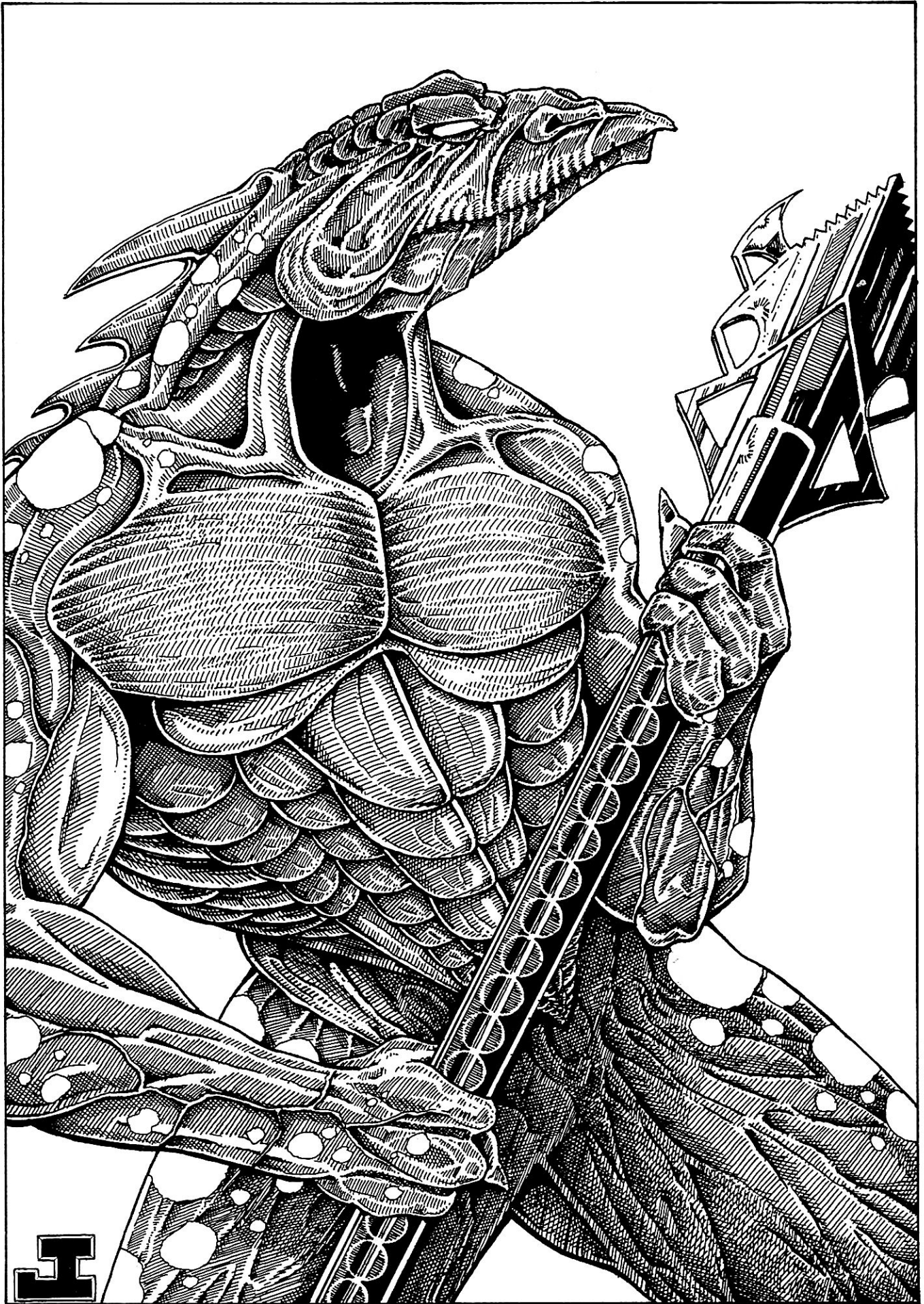

## Occupational Skills

**Electrical Engineering:** Designs electrical circuits, utilized in spacecraft and other machinery. SC: 6

**Hydraulic Engineering:** A hydraulic engineer designs systems that use pressure or liquid to facilitate systems functions. The car lift at your local mechanic is a system designed by a hydraulic engineer. SC: 5

**Ionization Control:** Ionization engineers monitor the ion drive engines on spacecraft. They must have one level of proficiency in electronics and hydraulic engineering, and two levels of nuclear engineering. Ionization engineers are easily hired as crew, if they have enough experience. SC: 9

**Mechanical Engineer:** A skilled mechanical engineer designs systems such as the automobile engine. He has an in depth knowledge of synchros as well as some knowledge of hydraulics. SC: 6

**Nuclear Engineering:** Incorporates all fields of engineering as well as physics into the design of reactors. Requires a diverse knowledge of materials used in these systems. One is well versed in the effects of radiation. SC: 7

**Robotics Engineering:** This is the ability to design artificial attachments for installation in robotics units. A robotics engineer can design integral parts of robots, as well as determine inherent defects in robotics equipment. This skill is similar to but separate from cybernetics engineering. Requires 1 level of both mechanical and electrical engineering. SC: 7

## ESPIONAGE

**Bribery:** Characters with this skill are proficient at "greasing palms" and usually know just how much to offer people to get what they want. They will also know if an individual can or cannot be bribed. SC: 2

**Camouflage:** Individuals know how to break up their outlines in any environment. They may also camouflage equipment. Unlike concealment, characters need not actually hide, because their camouflaging blends in with the environment. SC: 1

**Concealment:** Allows the character to conceal his body, in order to avoid detection. Characters use the surrounding environment to hide themselves. Three levels of Concealment yields a default of one level of Detect Concealment. SC: 1

**Detect Concealment:** Proficiency in this skill allows individuals to detect camouflaged persons, hidden traps, concealed vehicles, etc. This skill is often taken by counter espionage types. SC: 1

**Disguise:** Spies must infiltrate enemy positions. The character knows how to put on makeup and dress in the proper attire. SC: 3

**Escape:** The art of relaxing muscles, popping out bone joints, etc, to escape. Characters can slip out of handcuffs, knots, etc. SC: 3

**Forgery:** This skill provides the training to create passports, official documents, etc. The spy must have an original copy of the particular document to work with. SC: 5

**Impersonation:** Training provides the spy with the ability to impersonate others. The target individual must be of the same race and basic body build. The impersonator must have comprehensive knowledge of the target's physique, speech patterns, idiosyncracies, likes, dislikes, etc. SC: 5

**Infiltration:** Trained personnel are capable of avoiding/bypassing enemy defenses. A well trained infiltrator could move quickly past a guard post and under barbed wire fences without being detected. SC: 2

**Intelligence:** This skill concerns the compiling, analyzing, and interpretation of information gathered during spying operations. Intelligence experts are adept at extrapolating pertinent information and are aware of proper reporting procedures. Characters are trained in observation techniques. SC: 5

**Interrogation:** Proficient characters are skilled in extracting information, through the use of questioning, and more, uh... *direct* means. SC: 4

**Pick Locks:** The character is skilled in the techniques used to pick locks. He must have the appropriate tools to perform the act, though a credit card may do. Characters should purchase lock picks to facilitate the opening of locks. SC: 3

**Picking Pockets:** The character has the ability to remove small objects from pockets, such as keys, coins etc. Large objects, such as wallets and papers are considered difficult to snatch. An attempt to pickpocket takes 4-24 seconds. Failure by more than 20, or on a roll of 100, indicates that the character has been caught in the act. SC: 2

## JOURNEYMAN SKILLS

**Bartering:** Adds a +04% to bargaining checks per level of skill. SC: 1

**Carpentry:** Basic proficiency allows one to work with wood and build unsophisticated structures. SC: 2

**Cooking:** Persons with 10 levels of skill are considered Chefs. SC: 2

**Electrician:** Skilled electricians can rewire houses, repair faulty wiring, and other associated jobs. They are not electronics experts, although they have some of the basic knowledge of electronics repair. SC: 3

**Electronics:** Proficient characters can fix circuit boards and other electrical devices. It is by far the most pragmatic journeyman skill to take with a wide variety of application in the field. SC: 4

**Holo Installer:** Holo-men, as they are called, install holographic systems in homes. Holo-rooms are the rave and good Holo-men are in high demand. SC: 2

**Mechanic:** Can repair automobiles and other vehicles with the proper tools. A character who has attained 6 levels of skill in this field can repair atmospheric craft. 10 levels of proficiency allow one to repair trans-atmospheric vessels. SC: 3

**Mining (Planetary):** A lucrative profession. Proficient characters are able to discern whether a mine is safe, where veins are likely to be found, etc. SC: 5

**Welder:** Individuals can spot weld, arc weld, etc. SC: 4

## MEDICAL TREATMENT

**NOTE!!** All medical skills require at least two levels of basic.

**Basic:** Trained individuals can stop bleeding, splint broken limbs, and attend to minor burns. Characters tend to get shot up in Battl Lords quite a bit. Why? Because it makes things fun. So I strongly suggest that characters get some basic med. Basic med does have its limits. Persons cannot effectively work on any critically wounded individual other than those with clean wounds. SC: 1

### Examples:

Clean wounds (minor):	Level 1 difficulty.
1st degree burns:	Level 2 difficulty.
2nd degree burns:	Level 4 difficulty.
Simple fractures:	Level 5 difficulty.
Compound Fractures:	Level 10 difficulty.
Clean critical wounds:	Level 15 difficulty.
Compound spiral fracture:	Level 20 difficulty.

**Decontaminate:** A MUST for characters who intend to explore uncharted planets. Proficient characters possess pertinent knowledge concerning quarantine, decontamination, and isolation procedures. SC: 3

**Disease Diagnosis:** This field is oriented around the diagnosis of various diseases. Diagnosticians can spot symptoms and prescribe the proper treatment. They are trained to aid all of the races. SC: 3

**Disease Control:** The character is knowledgeable about quarantine procedures for different diseases and can also implement these procedures. SC: 4

**Infections:** Proficiency in this area allows the individual to treat body infections. The character knows the dangers associated with the infection as well as how to prevent its spreading. SC: 1

**Paramedic:** These individuals are trained to keep a person alive until such time as they can receive proper medical attention. They are not doctors, nor are they merely medics. They are highly trained and can perform minor surgery, such as amputating the leg of someone who happened to get in the way of our man Fredd the Python. SC: 4

**Poisons:** Characters diagnose and treat those who have been affected by poisons. The only stipulation is that they must have the means available to do so. Proficient characters have limited botanical and anatomical knowledge. SC: 1

**Radiation:** Can treat victims of radiation exposure. Treatment is subject to restriction, depending on the available facilities and medicine. SC: 4

**Surgery:** Surgeons are the doctors who sew you back up when you get into trouble in the field. They have extensive knowledge of anatomy, physiology, chemistry, etc. A level 5 surgeon can be licensed and practicing. You must have expended at least 20 points in other medical skills before choosing surgery. For every one level of surgery, you gain two levels of paramedic. SC: 7

#### Examples:

Lung surgery:	Level 5 difficulty.
Exploratory surgery:	Level 5 difficulty.
Heart surgery:	Level 15 difficulty.
Limb reattachment:	Level 15 difficulty.
Brain surgery:	Level 20 Difficulty.

## MILITARY SKILLS

**Camouflage:** Individuals know how to break up their outlines in any environment. They may also camouflage equipment. Unlike concealment, characters need not actually hide, because their camouflaging blends in with the environment. SC: 1

**Concealment:** Allows the character to conceal his body, in order to avoid detection. Characters use the surrounding environment to hide themselves. Three levels of Concealment yields a default of one level of Detect Concealment. SC: 1

**Demolitions:** Proficient characters know how to set explosive charges on structures. They are also trained in the handling and removal of explosives. SC: 3

**Detect Concealment:** Proficiency in this skill allows individuals to detect camouflaged persons, hidden traps, concealed vehicles, etc. This skill is often taken by counter espionage types. SC: 1

**Infiltration:** Trained personnel are capable of avoiding/bypassing enemy defenses. A well trained infiltrator could move quickly past a guard post and under barbed wire fences without being detected. SC: 2

**Interrogation:** Proficient characters are skilled in extracting information, through the use of questioning, and more, uh... *direct* means. SC: 4

**Mapping:** Proficient characters are able to map out features while adventuring. This skill is necessary if the party doesn't want to get lost, or if they wish to give coordinates to be picked up or call in artillery strikes. SC: 2



**Military Leadership:** Lead by example. PCs who wish to lead others enroll for a 5 week period of intense training at the Military Candidates School on New Terra. Characters may gain levels of proficiency in Military Leadership without attending a school, but that takes much longer to learn. Each level of Military Leadership increases one's secondary statistic by +06%. SC: 2

**Mountain Climbing:** The character is trained to climb mountains. He has limited knowledge of rock and soil type. He can also ascend or descend vertical surfaces. Proficient characters are aware of the typical dangers associated with operating in the mountainous regions. Each three levels of Mountain Climbing yield a default of one level of Climbing. SC: 2

**Navigation (land):** Proficient characters are able to use landmarks to navigate. They are also able to determine the fastest route between two points, given the proper information. SC: 2

**Repelling:** This isn't the same as mountain climbing. Repelling only involves descending vertical surfaces. A person with one level of repelling could descend a smooth surface such as a building face, whereas a level five person could repel down a cliff with loose rocks, and ledges. Characters with level 6 or higher can perform an Australian repel. This entails descending face first, with one hand free so that you can shoot on the way down. Repelling is good in the mountains or in urban areas where tall buildings are present. SC: 1

**Scouting:** Proficient characters are able to detect enemy positions and other hazardous obstacles. They are also adept at realizing where potential ambushes and traps would be set. Scouting is necessary if you are the "point man". SC: 2

**SCUBA:** Self contained, underwater, breathing apparatus. The character is versed in underwater hazards and is studied in decompression techniques. You need two levels of swimming to learn SCUBA. SC: 2

## Occupational Skills

**Set Traps:** This skill provides the ability to locate, set, find, and remove traps. It is vital for adventuring. SC: 2

**Sighting:** Sighting entails locating objects quickly and identifying them. Proficient characters gain a +04% to sighting checks per level of skill. Cizeracks gain a +06% per level of skill. SC: 1

**Spelunking:** Cave exploration. Proficient characters can operate in caves. They are aware of potentially dangerous obstacles and hazards associated with caves. Spelunking involves limited repelling. A character with 3 levels of spelunking gains a default of one level in Repelling. Also, three levels of Spelunking yields a default of one level of Climbing. SC: 2

**Survival (arctic, desert, deciduous, methane, tropical, swamp):** Proficient characters are able to survive in a particular type of climate. They possess knowledge of the general dangers associated with such an environment. SC: 2

**Survival (emergency):** Proficient characters are able to deal with various emergency situations, such as decompression of a spaceship. SC: 3

**Survival (Urban):** Proficient characters know how to live within an urban environment. They can shop, find a job, and generally get by. Persons not familiar with urban life will often be bewildered and lost in large urban settings. SC: 2

**Throwing:** Throwing skill measures the ability to accurately throw an object. Proficient characters gain a +04% chance to hit the target per level of skill. One can throw a knife or grenade a up to a maximum 1/2 of one's strength in meters. This distance is less for large grenades. SC: 1

**Tracking:** Tracking is a measure of one's ability to follow the trail left by the passing of another individual. Tracking is possible outdoors and underground. Tracking outside requires that the tracks be observed within 30 hours of passing. While tracking, a PC must concentrate on the tracks alone and may not engage in any other activity.

Proficient characters can track indoors or underground at a level 5 and track a creature outside at level 1. This is assuming ideal conditions. Rain, rocky terrain, and old trails all increase the difficulty level, while snow, mud, and large groups improve the chance. A skilled individual is able to extrapolate pertinent information about the tracks such as size and type of creature. SC: 2

## ROBOTICS

**Activate/Deactivate:** Proficient characters are able to locate a robot's system enable mechanism. They can activate or deactivate robotics systems. Some robots have defensive measures to prevent unauthorized tampering. SC: 3

**Robotics Engineering:** This is the ability to design artificial attachments for installation in robotics units. A robotics engineer can design integral parts of robots, as well as determine inherent defects in robotics equipment. This skill is similar to but separate from cybernetics engineering. Requires mechanical and electrical engineering. SC: 7

**Function Alteration:** Allows one to change the programming in a robot's electronic circuitry. This is not the same as Activate/Deactivate. Proficiency does not mean that the character can spot or remove the defensive measures that protect a robot's programming circuitry. SC: 4

**Identification:** The character is able to identify the different types of robots. Proficient characters are aware of the general type of weapons systems and special functions that the particular robot typically carries. SC: 1

**Modification:** This skill involves the modification of a robot's body, by adding or deleting parts. It requires a level of electrical engineering and mechanics. SC: 5

**Repair:** An excellent job skill and the pay is great. Robotics technicians are in high demand throughout the galaxies. SC: 6

## SCIENCES

**Anthropology:** The study of cultures, both current and ancient. Proficient characters know how to interact with different races. SC: 2

**Archaeology:** The scientific study of historic or primitive peoples and their cultures through the analysis of artifacts, monuments, etc. Archaeologists are often hired by exploration teams. SC: 2

**Biology:** The scientific study of living matter in all of its forms. Again, proficient characters are in high demand across the galaxy. Biologists travel to planets and study the various bio-cultures. SC: 3

**Botany:** The study of plant life. Proficient characters can determine whether the indigenous plant life is dangerous. Botanists are often hired by planetary exploration teams. SC: 3

**Chemistry:** Proficient characters can synthesize new compounds. Chemists test compounds to determine their nature. SC: 3

**Cryptography:** Cryptography deals with the encoding and decoding of messages. SC: 4

**Forensics:** Forensics is the ability to examine and evaluate physical evidence at the scene of a crime. This skill is vital to successful adventuring. SC: 4

**Gemology:** Proficient characters can determine the value of a particular gem. They are gem cutters. Mining Away Teams (MAT) hire gemologists along with planetary exploration teams. SC: 3

**Geology:** Geology is the study of the origin, history, and structure of a planet. SC: 3

**Physics:** Physics is the empirical study of energy in all of its various forms. Its applications are numerous. SC: 5

**Theology:** The study of religions and their cultural applications. SC: 2

## SECURITY SYSTEMS

**Activate/Deactivate:** This skill will allow proficient characters to turn alarm systems on or off. SC: 4

**Detect:** This will allow characters to find security systems where they may not be readily noticeable. This covers UV beams, bio-sensors, and other hidden security measures. SC: 3

**Operate:** Allows a character to manually control a security system, so that a false message can be sent, or automated defenses can be utilized. SC: 2

**Pick Locks:** The character is skilled in the techniques used to pick locks. He must have the appropriate tools to perform the act, though a credit card may do. Characters should purchase lock picks to facilitate the opening of locks. SC: 3

**Systems Design:** Proficient characters can design their own security systems, with whatever sensing devices and security measures they prefer. SC: 6

## VEHICLES

**Automobiles:** Characters can pilot most urban land vehicles, such as sandrats, trucks, and cars. SC: 1

**Fighters:** Pilots are trained to pilot atmospheric combat vehicles. SC: 5

**Fighters (deep space):** Pilots are trained in the use of space fighter craft. Two levels of proficiency yields a default in transcruisers. SC: 6

**Hoppers:** Hoppers are high altitude aircraft designed for long range travel. With this skill one can pilot these vessels. SC: 3

**Remote Piloting:** Good to know. One can remote pilot vehicles from their position in orbit to ground units. Characters can also attempt to pilot vehicles from ground to space. This is much more difficult and incurs a minus 30% penalty to skill checks. SC: 5

**Skimmers:** Skimmers are low altitude aircraft such as hover craft and anti-grav vehicles. Proficient characters can pilot most commercial vehicles of this type. SC: 2

**Spacecraft:** The training required to pilot space vehicles. Any person seeking acceptance in the Deep Defense Fleet must have a minimum of 5 levels of proficiency in piloting spacecraft before applying. SC: 6

**Tanks:** The character is skilled in the operation of heavy machines, mobile artillery and rocket launcher vehicles, rovers, and tanks. SC: 3

**Transcruiser:** Transcruisers are privately owned craft that are capable of atmospheric or trans-atmospheric movement. 2 levels of proficiency provide a level 1 default in Hoppers. SC: 4

## GUNNERY

A gunner chooses the basic field of endeavor. He is able to operate vehicle-mounted, heavy weapons (machine guns) systems of that type. Once he has obtained 10 levels of proficiency, the cost to learn more levels in that field is reduced by 1 point. Whenever a character has attained 20 levels of proficiency in a gunnery skill, the cost for advancement is lowered by 2 points. Each level of gunnery improves accuracy with the respective weapon by +04%.

## WEAPONS

Characters choose a basic weapons field to be proficient in. Each level of proficiency adds a +04% modifier to dice rolls when determining the attack percentage. The time required to correct a malfunction is reduced 1 second per 3 levels of skill attained. There is a minimum correction time of 1 second. Once a character has 10 levels of proficiency in a specific weapons field, the cost of learning a new level in that field is reduced by 1 skill point. At 20th level of proficiency, the cost of learning a new level is reduced 2 points below normal. The cost to learn a new level of weapon proficiency may never be zero! Characters competent with Archaic Hand Weapons, receive a +04 to parrying attempts when applicable.

**Archaic Hand Weapons:** See Physical skills. SC: 2

**Archaic Powder Weapons:** These outdated weapons use an explosive powder to propel an object at high speeds. Commonly used on tech 2-3 planets. SC: 2

**Beam Weapons:** Skilled personnel can utilize most laser and beam weapons. SC: 3

**Energy Weapons:** This skill covers a variety of advanced energy weapons such as disruptors, disintegrators, meson guns, metal guns, and flamethrowers. SC: 3

**Direct Fire Weapons:** Trained personnel can operate anti-tank weapons, rocket launchers, mag guns, etc. SC: 3

**Indirect Fire Weapons:** Trained personnel can operate mortars and grenade launchers. SC: 3

**Omega Weapons:** Omega weapons (Thud guns) cause damage by smashing the target with a projected force field. SC: 4

**Particle Weapons:** Particle weapons propel anti-matter particles at the target. These particles can be made to bend around corners. This skill allows use of these weapons. SC: 3

**Pulse Weapons:** This skill allows use of plasma weapons. SC: 4

**Repair (weapon):** Character can be trained to repair their weapons in case of a system breakdown. The cost to learn to a specific weapon repair skill equals the cost necessary to learn the basic skill itself.

**Repair (armor):** Requires 2 levels of electronics and welding. SC: 4

## MISCELLANEOUS STUDIES

**Accounting and Finance:** The person keeps the books of a company or works for the Galactic Banking Firm. SC: 4

**Administration:** Characters with this skill are proficient in dealing with bureaucracy in all its forms. They can cut through some of the red tape to get things done quicker. SC: 5

**Business Management:** These people run businesses. One must be smart and cunning to climb the corporate ladders. SC: 4

**Etiquette:** There are millions of planets in the universe, and hundreds of races. This skill will give you a basic proficiency in how to act around some of the more usual races. Be careful though, some races have really weird customs. SC: 3

**Gambling:** Proficient characters know a variety of card games. They can read an adversary's expressions. Very skilled card players can also count cards (level 10). SC: 2

**General Knowledge:** The person is a trivia buff and can try out for local game shows that employ trivia questions. He is also well versed in a variety of useful/useless knowledge that may come in handy at odd times. Each level of skill raises Terrestrial Knowledge by +04%. SC: 1

**Law:** One is studied and versed in the basic knowledge of Galactic law. You may practice law upon attaining 10 levels of proficiency in this area. Those with 18 skill levels of proficiency, may become judges. SC: 4

**Linguistics:** The study of language and its usage. Once a character has attained four levels of this skill, he can learn any new language for one point less than the normal cost. At 10 levels of skill, he learns new languages at two points less than the normal cost. SC: 4

**LMM (Life Module Management):** The futuristic hotel manager. Charisma affects the ability of an individual to perform this skill and deal with customers. SC: 2



**Matrix Manipulation:** This skill allows one to modify an energy matrix to some other form. The matrix controller attempts to restructure the matrix. The Battle Master determines the degree of difficulty. A level one manipulation would be a slight alteration like reducing the intensity of the matrix's effect, while completely changing a matrix might be a level 20 difficulty. SC: 4

**Mazian Shape Changing:** This skill is only available to the Mazian race. It is practice with the natural ability to change shape. As skill level improves the Mazian is able to imitate more difficult shapes. SC: 3

**Persuasion:** A player with "The Gift of Gab" is capable of convincing others to follow his directions. People tend to side with him in discussions. Oratory classes improve this ability. A character may try to convince others around him by practical application. Player characters with a persuasion proficiency add 04% to persuasion checks per level of achievement. SC: 1

**Street Smart:** Street Smart characters can survive on the streets, without running the same risks that a normal person does. They are wise to the events occurring around them and are adept at seeking out places and gaining information. SC: 2

**Survival (Urban):** Proficient characters know how to live within an urban environment. They can shop, find a job, and generally get by. Persons not familiar with urban life will often be bewildered and lost in large urban settings. SC: 2

## LANGUAGES

Characters have the option of learning different languages throughout their adventuring careers. PCs are often forced to interact with various cultures. Being able to speak several different languages can be advantageous. All player characters begin the game with a language proficiency in Earth English and the language of their race. These don't cost anything. It is assumed that the character learned them during his childhood.

To gain additional languages, a character must expend proficiency points and pay the money for lessons. It costs 3 proficiency points to become highly skilled in a language. Proficient characters can fluently read, write, and speak the language of their choice. Characters may opt to learn only functional or basic proficiency in a given language. One who speaks functionally has full comprehension of most normal conversations. He can write and speak the language, but has not mastered it completely. He only pays 2 points to become functionally literate. One may choose to learn only the basics of a language. Just enough to get by as a tourist. This costs 1 proficiency point. Characters may choose to learn:

### Common Languages of the Alliance:

Aziam	Benjari	Cashou	Chatilian
Cizerack	Eridani	Fott	Earth English
Hemarean	Madusiam	Mazian	Mutzachan
Orion Rogue	Phentari	Povonixza	Python Lizard
Ram Python	Sarands	Tasirins	Vissu
Wakon	Washiran	Xarian	Zen Rigeln
Zendarean			

**Aziam:** A giant, humanoid warrior race. The head vaguely resembles an elephant's, without the tusks. Aziam are often employed as bounty hunters. They are common in the Epsilon Delta and Epsilon Indi star systems. The Aziam have 10+d8 body points and gain a combat initiative bonus of -2. Their home planet, LC-3-A, has been annexed by the Alliance and is awaiting entry into the Council of Timar.

**Benjari:** A humanoid slave race, indigenous to the CD-14 system. This particular race is fundamentally barbaric. Benjari are loyal to those owners who treat them well. They are common throughout the galaxy.

**Cashou:** A slave race, indigenous to the Eridani star system. Cashou are quadruped, insect-like creatures, that fly. Masters enslave them to the Masange nectar which is highly addictive. This race has been exported all over the known universe.

**Fott:** Large, bipedal rabbit-like creatures who are often hired as mercenaries. They are fast and nimble. A Fott has 4+d8 body points and hops at speeds in excess of 40kph. Fotts are indigenous to the Netas Hydri system. They lean toward evil.

**Hemareans:** Hemareans are identical to humans, except that the Hemareans have gray-blue scaly skin. This race excels in logic and is incapable of telling a lie. Hemareans are often hired as military or expedition advisers. Their home planet is located in the Antares star system.

**Madusiam:** A race of independent, bipedal, two headed cat-like creatures. The Madusiam synthesize and sell the rare serum Nero-zynine which is used to produce the Body Rehabilitation Drug. They are indigenous to the Taos system.

**Povonixza:** Intelligent, kelp-like creatures, indigenous to the oceans of the Alpha Centauri and Beta Centauri star systems. This race is capable of a temporary symbiotic relation with an oxygen breather. The kelp attaches itself to the mouth of the wearer, conferring upon him the ability to breath underwater. In return, the Povonixza ingests a tiny portion of the CO<sub>2</sub> that is exhaled. The CO<sub>2</sub> acts as a cleansing agent to its circulatory system.

**Sarands:** The Sarands are frail humanoids with a large cranial surface. They live for 5-6 thousand years and are called the Galactic Sages. They possess a vast knowledge of the known universe and it's history.

**Tasirins:** Descendants of the Atlantians that made an exodus from Earth to the stars. The Tasirins are identical to humans of the pre-genetic era. They have 2+d6 body points. Tasirins have evolved into mathematical geniuses and are employed as engineers, physicists, chemists and the like. The females are very sensual, used as sexual concubines by many races.

**Vissu:** Insectoid desert nomads, indigenous to the Char system. Sarands possess advanced techniques in the mining of Titrutium 305. They are resistant to radiation and are often employed to mine the valuable metal. Titrutium is used to fuel the ion drive engines.

**Wakon:** The Wakon is another humanoid slave race, indigenous to the Andromedan Galaxy. Wakon are rebellious and difficult to handle. They command the lowest of all the prices at market.

**Washiran:** An independent race of small cat-like beings. Washiran inhabit the Haniz star cluster. The race is thriving and operates their own Galactic vessels. The Washiran have a formidable military force, including galactic class warships. All attempts to conquer the cluster have failed. The Washiran distrust Gen-Humans and Humans intensely, but have developed a rapport with the Cizerack and Mutzachan races.

**Xarian:** A merchant race who resemble bumpy, six legged tables. The Xarians come from the Magellanic Clouds. They have direct ties to the Arachnids. Coercion has failed to gain information from these beings about the disposition of the enemy spiders. They are rarely seen in the Galaxy, except to deliver shipments of Titrutium 305.

**Zendarean:** "The Blue Human." Zendareans resemble humans, except for color of skin. These beings are alluring. They are sold as concubines, mostly to the Gen-Humans.

# ARMOR

Armor is of vital importance to all warriors. The choice of which type of armor to purchase is just as important as which weapon to carry. It is the opinion of most warriors that armor is indeed the more important of the two. Body armor has three very important aspects: armor integrity, threshold rating, and absorption rating. Each is discussed below, as well as other factors such as SMRs vs special attacks and space available for a variety of options. Once a character buys his armor, the necessary information is written in the appropriate section of the character sheet. As damage is incurred, the suit may have its functions reduced.

*Body armor is an essential aspect to defeating the enemy on the battlefield. Its importance should not be overlooked on a purely cost based analysis. Preliminary tests results on the use of battle armor in combat situations, unequivocally prove that combat soldiers protected by battle armor are exponentially more likely to survive... It is incumbent on this presidential administration to back the further study of the uses of body armor for its practical applications in a combat environment.*

Taken from the Ramcor Combat Report  
Major General Zak Doherty  
6/21/2035

There are two types of armor: normal and heavy. Normal armor has a threshold of 6 or less. It is usually not environmentally sealed. Any body armor with a threshold of 7 or more is considered heavy armor. All heavy armor is environmentally sealed, temperature regulated, and provides a +20 vs all SMR checks. Heavy armor is not affected by normal kinetic attack forms (bullets and archaic hand weapons) and lasers inflict only half normal damage. Missiles, arm rockets, and vehicle weapons (like the machine guns) are not considered normal kinetic attack forms. They are equally effective against heavy and normal armors. Both types of armor can be modified to carry options.

Armor is repaired through the combined use of the skills of mechanical engineering, hydraulic engineering skill, and welding.

**Armor Integrity:** This denotes the amount of damage that the armor can withstand before it is rendered useless. Certain weapons rip large holes in body armor when they strike, while others inflict only minimal damage. Bullets and lasers reduce armor integrity by 1 point per hit, pulse weapons cause 8 points of damage to integrity, and omega weapons do zero damage, as the omega pulse is translated directly through the armor as a concussion wave. Each time damage exceeds the threshold of the armor (see below), integrity is reduced. If integrity reaches zero the armor is destroyed.

**Example:** A Flex suit has an armor integrity of 120. Therefore, it can take 120 bullet hits before it becomes useless. Pulse cannons reduce armor integrity by 8 points per hit. The same Flex suit can withstand 15 hits from a pulse cannon before it is "slagged".

**Threshold Rating:** This is the amount of damage that the armor stops per attack. Threshold reflects the relative toughness of the armor. Each time a suit sustains a weapons hit, the wearer must determine whether the attack bounced off or penetrated the armor. Any attack that does less than or equal to the threshold rating of the armor is deflected, and no damage is sustained by the armor or the wearer. However, if the attack does more damage than the threshold rating, the armor has been punctured. The armor integrity is lowered by the appropriate amount (as determined by weapon type), then the amount of damage that actually penetrates to the absorption layer is calculated by taking the total amount of damage rolled and subtracting the threshold. The result is the amount of damage that strikes the absorption polymers.

**Example 1:** Henry the Mutzachan is wearing a suit of AKMB armor that has a threshold rating of 4. A bullet from an M-16 strikes the armor. Damage is rolled with a result of 3 points. The bullet

ricochets off the armor. A hit that doesn't penetrate the armor does not affect the armor integrity.

**Example 2:** The same AKMB suit is struck by another bullet from an M-16. The round does 6 points of damage. The bullet penetrates the armor and the armor integrity is reduced by 1 point. All penetration damage is reduced by the value of the threshold. Thus, the bullet fired from the M-16 does 2 points of damage to the absorption polymers.

**Absorption Rating:** This is the amount of damage that the flex polymers can absorb before the owner takes damage. Each time the threshold is exceeded the damage penetrates to the absorption layer. When this layer is struck, the rating is reduced permanently by the amount of damage that penetrated. When absorption reaches zero, additional damage is translated to the wearer. Note: Even if the absorption layer is destroyed the armor still has its threshold rating, until the integrity is also reduced to zero, signifying the destruction of the armor. Players can have destroyed polymers replaced between missions. The cost to replace lost polymers is 100cr/point.

**Example:** Henry's AKMB armor doesn't initially stop the penetration of a bullet that does 6 points. The round goes through the 4 point threshold, reaches the absorption layer and the AR is reduced by 2.

**Encumbrance:** This represents the weight and bulk of the armor when worn. Since encumbrance has a direct affect on the ability to move, players should carefully choose their armor so as not to weigh down their respective characters. If the hydraulic systems are knocked out on **Heavy Armor**, the encumbrance value of the suit immediately becomes 2 times the total armor integrity. Normal body armor weighs twice its encumbrance value when carried.

**Example:** Henry the Mutzachan is wearing Repulsor heavy armor when his hydraulics get knocked out by an Arachnid with an EMP cannon. His armor now weighs 240 encumbrance. Our hero falls over like a rock. The Arachnid approaches! Oh no! Messy. Very messy!

Armor integrity, encumbrance, cost, and spaces available for options are relative to the size of the armor. The values given below are for someone who is size class 4. To determine the value for your size:

MULTIPLY EACH VALUE (AI, ENC, COST, SPACE)  
BY THE WEARER'S SIZE CLASS DIVIDED BY 4.

**Note:** Cizerack is considered size class 7 for armor size values.

## KEY TO ARMOR TABLE

**ELE:** This denotes the SMR for the armor against electrical attack forms. Whenever your armor is exposed to electricity, a roll is made to determine whether or not the hydraulics shut down. Electrical attacks generally reduce absorption by 2-8 points.

**EMP:** This relates the armor's ability to withstand an attack from an electromagnetic pulse. Again, a failed electromagnetic pulse SMR roll indicates that the hydraulics (for heavy armor) have shut down. All electrical armor options will also be shut down on any armor.

**FIR:** All armor has an SMR vs fire. I don't mean campfires, but rather super heated fires. An SMR is not rolled when the armor is hit by plasma weapons. It is used if the suit is struck by a flamethrower or something of that type. A failed SMR indicates that the armor's Flex Points (plastic/metal joints around areas such as the knees) have begun to melt. Armor integrity is reduced by 2-12 points, and your agility is dropped by 2-12 points permanently due to joint fusing. The effects lasts for as long as the individual wears the armor or until he has the problem fixed.



I BRAKE FOR PAIN

BSH HC 4320434

MO<sup>87</sup>

**COLD:** This SMR is rolled whenever the suit of armor is exposed to temperatures of less than -10 degrees Celsius. Flex Points freeze when the armor fails and the owner loses 3-18 points of agility while in the armor. A failed cold SMR for a helmet results in the user not being able to move his head (-5 to agility).

**CRT (Optional):** This number relates the relative design of the suit itself against weapon hits. Whenever a penetrating weapons hit is indicated, roll a Critical (CRT) SMR. Failure indicates that an armor system has been hit. Roll the area hit on the Critical Tables and apply the results.

### Critical Hits

<b>Arm</b>		<b>Abdomen</b>	
01-30	No critical	01-20	No Critical
31-80	Servos	21-30	Temperature Control
81-100	Hydraulics	31-70	Hydraulics
		71-85	Engine
<b>Leg</b>		86-95	Engine (overheat)
01-60	No critical	96-100	Engine (critical)
61-75	Servos		
76-100	Hydraulics	<b>Head</b>	
		01-10	No Critical
<b>Chest</b>		11-20	Communications
01-20	No Critical	21-40	Temperature Control
21-75	Hydraulics	41-80	Electronics
76-85	Engine (overheat)	81-100	Hydraulics
86-100	Engine (critical)		

### ARMOR OPTIONS

Armor options are devices which are added to the defense suit to enhance the survivability of the soldier. Their use is extremely important, as much as, if not more than, the threshold and absorption of the armor itself. Armor options are normally mounted on the armor, although there are some that are built into the armor itself. Options take up space, and sometimes add weight. Each section of armor contains a specific amount of space which may have options added onto it. You can never mount more units than you have space for. The number of spaces available (given below) are for a size class 4 individual only. As stated above, the amount of space available depends on your size class. Round fractions down.

<b>LOCATION</b>	<b>UNITS</b>	<b>LOCATION</b>	<b>UNITS</b>
Lower Arm:	3	Abdomen:	50
Upper Arm:	2	Chest:	40
Lower leg:	5	Head:	6
Upper leg:	10		

**Example:** A suit of AKM (size class 4) has 3 units of space in the lower arm section for options. Thus, you could mount 2 arm rockets (1.0 units each) and 4 additional points of absorption (0.25 units each).

**Example:** An AKM suit for a Ram Python would have 6 units of free space available in the lower arm. Size Class 8;  $8/4=2 \times 3=6$ .

**Note:** Street series armors and bulletproof vests may not mount any armor option that is greater than three spaces. Bulletproof vests may not mount arm or leg options.

There are those options which are built directly into the suit, such as a rad-liner, or environment containment. These are considered to take up no space. They can not be removed and transferred to your new armor. However mounted options can be transferred.

When you take damage, your options can get knocked out. The chance of this happening are as follows: Number of spaces the option takes up divided by number of spaces in the section that got hit, times 100. If you roll less than that number on percentile dice, your option has been destroyed. A single hit can only wreck a number of options equal to the number of points of AI lost due to that weapon hit. So,

bullets can ruin 1 system per hit, while Pulse Cannons can ravage 8 options in 1 shot! Of course, you can't lose more than you have. Roll for the largest options first.

**Example:** That AKM suit above with the 2 arm rockets and the 4 additional points of AR is hit by an AK-57. The bullet penetrates, reducing AI by 1 point. Therefore, the victim will lose at most 1 of the arm rockets. The chance for each rocket to be hit is:  $1.0$  (the space they take up) /  $3$  (the space available)  $\times 100$ . This is equal to  $.333 \times 100$ , or 33%. Roll percentile dice. If you roll less than 34, your arm rocket is destroyed. You must roll for both rockets, but if one is destroyed, you don't need to keep rolling. If you had been hit by a Plasma burst, you could lose all of your rockets!

### THE EFFECT OF WEAPONS HITS

Different weapons system do different amounts of damage to the armor integrity per penetration. The number given below is the amount of damage to AI, as well as the number that you must subtract from the CRT chance when rolling to determine if a critical has been sustained.

<b>WEAPON</b>	<b>IR</b>
Crossbow Bolt, Pulse Weapons	1
Standard Bullet	1
Grenade Fragment	1
Laser	1
Heavy Laser (max. dam. > 12)	2
Dossien, Spear, Ptfaang types	2
Short Sword, Long Sword	2
Phosphorus	2
Incendiary Round	2
Impact Lasers	3
Broad Sword, Mace	3
Machine gun	3
Acid	3
Plasma Fragment	4
Two Handed Sword	4
Explosive Bolt or Arrow	4
Omega Cannon	0
Super Plasma Fragment	5
Plasma Cannon	8
Plasma Seduction Fragment	8
Arm Rockets	10
Reflex Missiles, Personal Missiles	25
Anti-Tank (Tech 2-3)	50
Shadow Missiles	50
Anti-Tank (Tech 4-6)	100
Disruptors, Disintegrators	(equal to damage done)
Metal Guns	(equal to 5 times the threshold reduction)

### DAMAGE ALLOCATION (optional)

Damage Allocation is used to provide a more accurate accounting of weapons hits to body armor. It use is optional, slowing the play of the game down. It does, however, make the game more exciting. How does it work? The body is broken down into sections, arm, leg, abdominal, chest cavity, etc. The total amount of absorption and armor integrity is divided amongst the various sections. The division is done as such: Each arm section of the defense suit holds 10% of total absorption polymers, The legs each hold 20%. 20% of absorption and armor integrity are allocated to the abdominal cavity (lower back included) and finally 20% is allocated to the chest. At times, you will obtain fractional result when you attempt to divide up the armor. In this case, round all fractions down and add the residual amount left over to the chest cavity (the most important part of the body). Concussion damage is divided up among all sections of the armor and head. Again, residual concussion damage is taken on the chest.

**NOTE!!!** The head is a different section. It is not part of the body. The neck is considered part of the head section. For all you MORONS who don't read the book, open face helmets don't protect your face or neck!

**Example:** A suit of AKM (size class 4) has 20 points of absorption and an armor integrity of 90. Each arm would contain 2 points of absorption and 9 points of armor integrity. Each leg would have 4 points of absorption allocated to it and 18 points of armor integrity. The abdominal and chest cavities would contain the same. Therefore, the arm could be hit with 9 different archaic powder hits

(reducing 1 point apiece) before the armor integrity is rendered uselesssand 2 points of penetration damage before the absorption is gone.

**Example:** A suit of Bear (size class 4) has 130 points of absorption and an armor integrity of 100. The arm section could withstand 10 points of armor integrity damage and 13 points of absorption damage.

### BODY ARMOR

TYPE	AI	THR	AR	ENC	ELE	EMP	FIR	CLD	CRT	COST
Banded	35	3	2	17	—	—	40	40	—	120
Chain	20	2	4	12	—	—	30	30	—	100
Leather	8	1	4	8	—	—	15	—	—	70
Plate	42	4	4	30	—	—	50	—	—	130
BP-1	10	2	2	6	—	—	40	60	—	100
BP-2	20	3	4	8	—	—	40	60	—	150
Street 1	20	3	10	12	—	—	30	30	—	3000
AKM	90	3	20	22	—	30	60	60	70	450
Cub	120	3	70	25	—	35	45	45	75	2500
Street 2	40	4	40	15	—	—	40	40	—	15,000
AKMB	120	4	40	8	—	30	60	60	75	1400
Welch	150	4	30	22	—	45	62	62	60	3500
Reflection	130	4/8	25	7	—	40	75	75	85	10,000
Guisarme	150	4	40	6	40	25	35	35	75	20,000
Bear	100	5	130	26	—	50	60	60	90	12,000
Flex	210	5	50	24	—	45	63	63	85	8000
Street 3	60	5	60	20	—	—	60	60	—	40,000
BSH	120	6	30	29	—	30	70	70	80	14,000
D2	180	6	80	22	—	60	80	80	95	30,000
Kodiak	150	6	150	20	—	65	65	65	100	50,000
Streetwise	80	6	100	15	—	—	70	70	—	90,000

### HEAVY ARMOR

TYPE	AI	THR	AR	ENC	ELE	EMP	FIR	CLD	CRT	COST
CD 2	180	7	120	20	90	70	85	80	100	92,500
Gladiator	250	7	240	20	95	55	68	70	100	200,000
MX-4	210	8	120	17	85	85	80	100	100	145,000
Repulsor	120	9	80	18	95	80	95	95	100	150,000
Mesh	160	10	120	18	100	90	90	80	100	160,000
Tri-Mesh	410	15	180	16	100	95	93	90	102	290,000

### MECHANIZED BATTLE ARMOR

TYPE	AI	THR	AR	ENC	ELE	EMP	FIR	CLD	CRT	COST
Assault	440	22	300	5	100	100	100	100	104	0.5M
Heavy Assault	500	28	500	4	100	100	100	100	106	1.0M
MBA	560	35	700	2	100	100	100	100	108	2.0M
Argus	500	50	350	4	100	100	100	100	110	4.0M
Dreadnought	10HP	1HP	8HP	4	100	100	100	100	104	20.0M

### SPECIALIZED ARMOR

TYPE	AI	THR	AR	ENC	ELE	EMP	FIR	CLD	CRT	COST
T-12	—	—	4	—	—	—	—	—	—	10,000
EVM-1	8	2	4	12	40	50	50	50	—	1500
BES	25	5	25	21	80	55	55	80	80	20,000
ES-3	8	2	4	8	35	—	30	30	30	3000
Mazian Armor		SPECIAL			var	var	var	var	var	-20%

### HELMETS

TYPE	AI	THR	AR	ENC	ELE	EMP	FIR	CLD	CRT	COST
Kevlar 3	10	4	4	2	—	—	40	40	—	150
Tri-lar	10	5	6	—	—	20	—	45	45	300
AKMH	8	7	6	3	—	35	50	55	65	950
DH-1	8	9	5	3	—	70	50	50	75	3000
Shalkon	10	10	8	3	—	70	60	55	75	8000
DH-2	12	12	5	4	55	50	80	80	85	18,000
Dancerz	12	13	6	5	75	70	90	90	85	25,000
Deshard	12	18	10	5	90	80	90	90	80	40,000
Tri Mesh	14	24	12	4	100	100	100	100	100	120,000

## HELMETS (continued)

TYPE	AI	THR	AR	ENC	ELE	EMP	FIR	CLD	CRT	COST
MBA	16	36	20	2	100	100	100	100	105	250,000
Bell SS	8	10	6	3	90	70	100	100	90	54,000
AKMS	6	10	5	3	90	75	95	95	80	56,500
Deshard S	12	18	25	5	92	80	95	95	95	85,000
Range Master	10	12	6	3	80	70	80	85	85	18,000
Shalkon MS	8	18	25	3	90	50	90	70	90	100,000
Jousen 3	8	24	15	3	95	70	100	80	95	150,000
Deshard X	12	32	20	5	100	100	100	100	103	200,000
Goliath	14	42	30	5	100	100	100	100	110	0.5M
Defender	20	56	50	4	100	100	100	100	110	0.75M
TDA	10	8	8	6	90	80	100	100	98	335,000
TDA-2	12	12	8	4	100	100	10	100	100	.5M

## MARS SYSTEMS

TYPE	AI	THR	AR	ENC	Cost
Guardian	500	28	500	4	3.0M
Warrior	560	35	700	2	7.0M
Hercules	500	50	350	4	10.0M
Titan	1000	100	800	4	32.0M

## TIES

TYPE	Size	ENC	COST
MasRock 550	30	100	5.0M
Argonite 1200	30	75	3.8M
Sprinkler	30	80	0.5M
ShadowFax	30	120	2.0M
Shadow Master	30	120	2.2M
Son of SAM	30	140	10.0M

## HIGH TECH ARMOR OPTIONS

Option	Size	ENC	Cost
Ablative Liner	-	.2	250
AMM	3.0	2	25,000
Anti-Plas Generator	10	3	75,000
Anti-Grav Belt	7.0	(-40)	75,000
Anti-Magnetic Generator	5.0	7	25,000
Arm Rocket	0.5	.5	1000
Auto Injector	0.5	.5	3500
BMH (basic)	10	4	1500
BMH (look and shoot)	10	2	35,000
Body Flares	1.0	2	10,000
Camouflage Unit	B	2	3500
Carrying Case	-	(1/8)	10,000
Corrosive Protection	B	0	1000
Cryo Option	.25	.5	25,000
Displacement Device	10	7	75,000
Drop Bag	10	2	5000
ECM (cost per +01 modifier)	2.0	0	1000
Electromagnetic Converter	4.0	4	25,000
Environmental Containment	B	0	1400
Flotation Device	8.0	2	2000
Flux Shield	20	12	150,000
Gills	2.0	1	2500
Grappling Hoist	5.0	3	1500
Grenade Launcher	3.0	3	5000
Gyro Stabilizers	1.0	2	2000
Heavy Belt	4.0	(-75)	125,000
Heavy Missile	-	7	200,000
Holographic Generator	35	5	250,000
Hover Jets	7.0	5	60,000
Infrared Dampener	3.0	3	4500
Infrared Discriminator	1.0	1	15,000
Insulation (EMP)	0.2	0	20,000
Internal Food Processor	2.5	3	1000
Jet Pack	40	35	35,000

Jump Pads	3.0	3	10,000
Kinetic Energy Shield	7.0	3	20,000
Laser Shield	1.0	10	35,000
Magnetic Disrupter	12	4	425,000
Magnetic Deflection Generator	10	2	30,000
Missile Rack	15	8	30,000
Mrs. Fusion	2	4	80,000
Oxygen Supply	3	4	750
Power Rack	15	15	34,000
Protection (absorption)	.25	.1	150
Protection (hydraulics) 1/2 section		3	10% armor cost
Protection (servos) 1/2 section		3	10% armor cost
Protection (plating) 1/2 unit 1/space			250/space
QSU	B	1	2000
Rad-Liner	B	2	250
Radar	3.0	3	60,000
Reflex Missile	-	4	10,000
Scatter Defense Laser Unit	14	3	40,000
Search Light	3.0	2	500
Shield	1.0	5	var
Skalers	2.0	0	2000
Smoke Generator	6.0	3	3250
Suicide Bomb	3.0	2	40,000
Talons	1.5	1	5000
Thermal Generator	6.0	5	30,000
UV Scrambler	5.0	3	15,000

**Banded Mail:** Strips of metal fused to each other. It is bulky, but can stop a fair amount of damage.

**Chain Mail:** An archaic armor, used by a variety of Tech level 1 societies. It has a fair threshold, but almost no absorption. The absorption listed is for the suit of leather that is normally worn under it. Chain Mail makes a lot of noise when you are moving in it.

**Leather Armor:** This is the stuff you get if you want to move quietly. It is light and flexible. You can swim in leather armor, but I highly suggest that you don't let it dry on you, especially if you are a male!!!

**Plate Mail:** This stuff was used by the knights on the planet Earth during the Middle Ages. It is heavy, cumbersome, and you're in deep trouble if you fall into water while wearing it. Of all the archaic Tech level 1 armors, this stuff is the best at repelling an attack. Plate Mail has the highest threshold and absorption rating of any archaic design.

**BP-1 (flak jacket):** An archaic design, first used to protect combat soldiers during the 20th Century. The jacket is fastened around the mid-section of the individual. The upper and lower extremities are vulnerable. Integrity and absorption apply to chest and abdomen only.

INFIRMARY  
Y-107J-110011  
Pz 11e 423 8L R11-0



**BP-2 (flak jacket):** An improvement over the BP-1. This jacket is considerably lighter than the BP-1 because of the Kevlar coated liner. The BP-2 has an improved threshold of 3 points. All integrity and absorption is applied to chest and abdomen.

**Street 1:** The first bulletproof clothing available. It can't take much but it is better than nothing. Affordable. Can be purchased in fatigue colors or normal street style. A metal detector or heat registering device can detect the presence of bullet proof clothing.

**AKM Body Suit:** Was designed by American Konglomerate Corporation in 1999. The AKM is considered the first true body defense suit. Unlike the flak jackets, the entire body is protected. This suit is somewhat cumbersome. The threshold is marginal and prolonged wear causes chafing.

**Cub:** Designed for short term combat exposure. The Cub has excellent absorption for the money and is nice if you just want to get in, take care of business, and get out. Then again, how often does that happen?

**Street 2:** An improvement over the Street 1. Heavy protection with only a little more bulk.

**AKMB Improved Body Suit:** A better version of its predecessor. The threshold rating has been increased to 4 points. The improved AKMB can absorb up to 40 points of damage before the flex polymers break down. Reasonable encumbrance and acceptable all around defense.

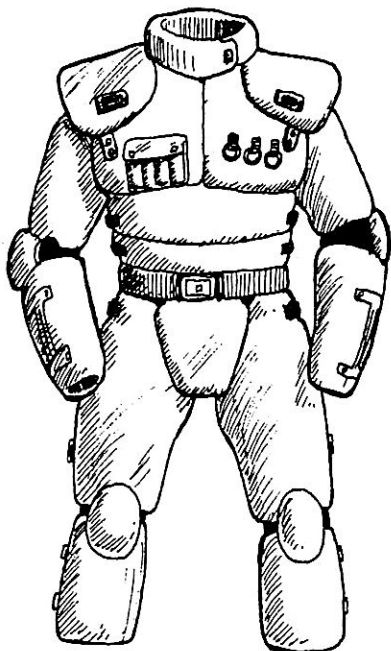

**Guisarme Jump Suit:** An experimental unit, designed by Charles Guisarme in 2055. The force exerted by the foot when walking or running is transferred by EAT (Energy Absorption Transfer) pads to a pressure plate and onto the pneumatic drive system. Hydraulic pumps work the action of the unit and propel the wearer along. The Guisarme has a maximum speed of 100kph. The drawback is that weapons hits to the drive systems can render the unit completely useless, leaving the wearer stranded in a very precarious position. No design has been made for non-humans.

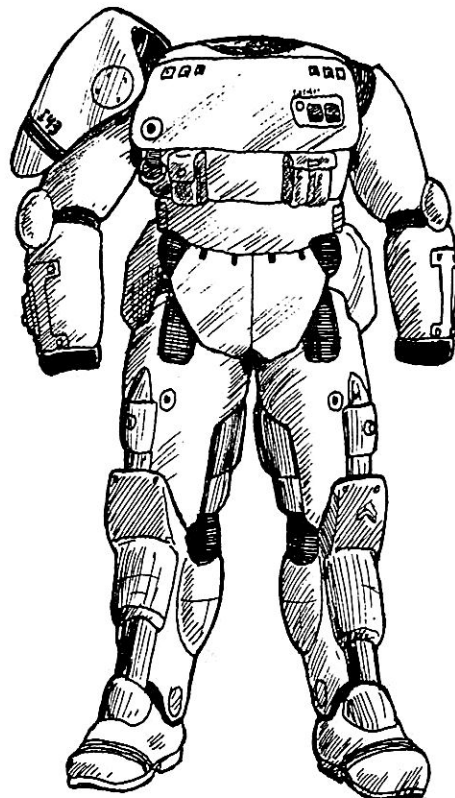

**Bear:** Affordable and functional for most situations. The Bear has good all around specifications and is not too expensive.

**Flex Suit:** A light weight defense suit, still in use by light infantry units on Tech Level 4 planets and lower. The impact layer is constructed of 1cm thick flex steel. It is light and highly maneuverable. The flex suit offers a 50 point absorption polymer system. It does have one major drawback. The unit is very susceptible to electrical based attacks and this attack form does double damage to absorption polymers.

**Street 3:** This suit is quite useable and the owner has a chance of surviving a burst of automatic weapons fire. It is quite heavy though.

**BSH (heavy suit):** Produced by Bonson/Sayers/Vion Corporation, a subsidiary to the Ramcor Corporation. This suit trades absorption for a thicker exterior armor. It is best used in situations where laser and powder weapons are involved. Quick strike operations often use this type of suit because mobility isn't significantly reduced. Not bad for the money, but limited in its tactical applications.

**Welch:** Not bad, but it lacks the absorption for extended combat situations. One burst of heavy machine gun fire can take you out.

**Reflection Suit:** It is designed to defend against laser attacks. This suit can reduce or completely nullify the effects of beam weapons. The cobalt armor alloy creates a scintillating mirror effect. All beam weapon hits that do less than 9 points of damage are deflected. All other weapons must exceed a 4 point threshold in order to penetrate. The absorption polymer layer can absorb up to 25 points of damage before breaking down. The inherent problem with wearing the suit is that the reflective surface can be spotted at great distances. Attackers gain a +30 to sighting checks at all ranges.



**D2:** Designed by Galactic Defense Contractors: The D2 is light and highly maneuverable. It has excellent specs and is considered one of the best all around buys.

**Kodiak:** Trades a little threshold for a lot of absorption. This unit is designed for medium intensity combat situations. The Kodiak can withstand several direct hits from most pulse weapons.

**Streetwise:** The most potent bulletproof clothing available on the market. It isn't as cumbersome as its predecessors, and it has enough absorption to ensure survivability.

**CD 2 Commando:** Take "look and shoot" wrist rockets, add a built in smoke generator, mechanized speed (like the Guisarme), and then you have the Commando. Each arm has two wrist rockets. Voice activated too! Maximum speed: 65kph.

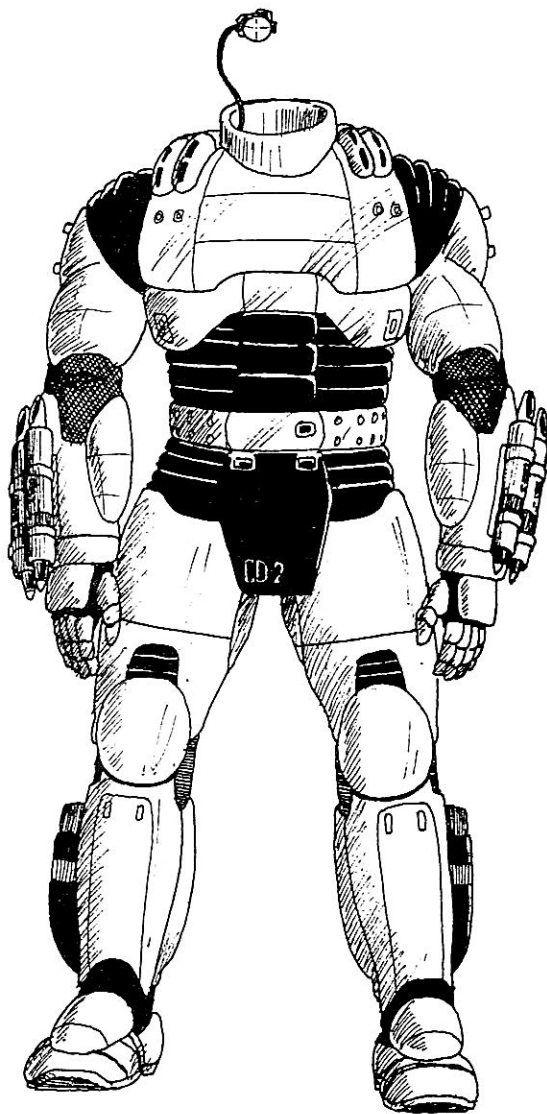

**Gladiator:** The most sought after body defense suit on the market. This unit is superb if you want to get up close and trash things. It doesn't have great threshold, but it makes up for this with an unbelievable absorption rating, unprecedented for those in its class. It is probably the best anti-pulse armor on the market. 8 Arm rockets are included in the cost!!! It is the favorite of Ram Pythons everywhere.

**MX 4:** The newest combat suit on the market. The MX 4 is designed to defend against Omega weapons. The special absorption polymers reduce the effects of sonic attacks. All concussion based attacks do 1/2 damage to the polymers.

**Repulsor:** Built with overlapping flex steel plates in some top secret configuration. The Repulsor boasts a 9 point threshold. This is the stuff you take against lasers!!!

**Mesh Suit:** Designed with intermeshing layers of armor and absorption polymers, of which there are two layers each. The Mesh Suit is definitely worth the money.

**Tri-Mesh:** Incorporates flex steel, TS-3 absorption foam, and special absorption polymers in a six layer configuration. Tri-mesh was fielded in 2150 and is still widely used to date. This suit has a great threshold rating, but the absorption configuration is even better!

**Assault Armor:** The first generation assault armor was a big step in creating the unkillable soldier. This unit is constructed of thin layered gauze-steel plates and incorporates the latest in absorption defense polymers. Assault armor is only 1.25 cm thick. This unit is designed for close proximity combat. It has a 22 point damage threshold and can absorb up to 300 points of damage. It is absolutely perfect for you "get up close and waste'em" types.

**Heavy Assault Armor:** An improvement over its cousin. Add another 0.16 cm of ST-3 foam, change the configuration slightly, and end up with 500 points of absorption, instead of 300.

**MBA:** There is nothing like it! MBA stands for Mechanized Battle armor. This armor utilizes the state of the art in body defense systems. The design is top secret and no one knows how to recreate it. Mechanized Battle Armor is only currently available to the Galactic Stormtroopers. It utilizes "look and shoot" technology and it is environmentally self-contained. This suit comes with multiple weapons systems (Choose 100,000cr worth) and has an unprecedented threshold rating of 35. It can absorb an unbelievable 700 points of damage!!! Check the Black Market if you are serious about picking up a suit.

**Argus:** The word stands for shield in the ancient Earth language, Greek. Argus has only been on the market for a little more than one month. It is in high demand, but the Guisarme propulsion unit has failed on numerous occasions. The manufacturers are currently under galactic indictments for misappropriation of government funds. Argus was designed to improve the survivability of the combat soldier against Omega weapons.

**Dreadnought:** Top secret and it isn't even available yet.

**T-12 Sonic Suit:** Designed to be worn under another suit or as clothing. The T-12 absorbs harmful concussive waves. The damage from all sonic, and concussive attack forms is halved. This suit also adds 4 points of absorption to each armor location.

**EVM-1:** Used by exploration units on planets with hostile atmospheres. The wearer is fully immune to the effects of acids/bases. This self-contained suit is not designed for combat and it carries a 6 hour air supply. Comes with an AKMH helmet.

**BES:** The Battle Environment Suit is the only suit, aside from the MBA, which has been designed for all purposes. It is fully self-contained, and has an oxygen (or methane) tank that holds a 10 hour air supply. It is protected by a 5 point threshold and any weapons hit that penetrates the tank only has a 15% chance to rupture it per point of damage sustained. Comes with an AKMH helmet.

**ES-3:** The standard space suit. The oxygen tank has an 8 hour supply. An additional tank can be carried. Comes with an AKMH Helmet.

**Mazian Armor:** Mazian wear special "baggies" for armor. To determine the cost, choose any listed modern armor of threshold 4 or less and reduce the price by 20%. The actual value of a baggy is much less than what a Changeling pays for it, but those are the breaks of living in a capitalist universe! Mazians can not wear heavier armor unless it is mechanized. A mechanized suit can be made into a mini-tank. This armor allows a Mazian to move quickly about at the cost of not being able to change shape. Thus a Mazian in a tank can not ooze or change.

## HELMETS

Unless otherwise stated, all helmets are assumed to have a commo module range of 10km.

**Kevlar 3 (OPEN FACE):** First fielded during the Mongoloid Invasion of 2001. This relic can't stop a bullet from a Colt Anaconda, though if you can't afford a real helmet, it will do.

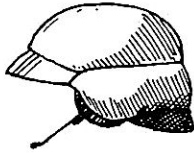

**Tri-Lar (OPEN FACE):** A good all around helmet, for those on a budget.

**AKMH:** Matched to the low line AKM series armor. The AKMH will stop approximately 5 rounds before the owner gets his brains scrambled.

**DH-1 Defense Helmet (OPEN FACE):** A great defense helmet for its time. It has a fair threshold rating and a commo range of 10km.



**Shalkon Helmet:** Trades threshold for absorption. The commo module is relatively strong, with a 20km range. The Shalkon helmet has a full face configuration.

**DH-2 Shock Helmet:** Produced in the latter part of the 21st Century. It can take a heavy weapons hit without the owner getting trashed. The DH-2 is a big improvement over the DH-1. It has a full face configuration with an adjustable visor. The headset has a range of 15km.

**Dancerz (OPEN FACE):** Contains an ECM unit in the rear section of the helmet. The Dancerz provides a -15 modifier vs electronic lock-on. It is an open faced, half shield, helmet.

**Deshard:** Designed by Jean Luc Deshard for the Balshrom Corporation. This "brain bucket" is good for stopping most laser attacks and you've got better than a 50/50 chance to survive a blast from a low line pulse cannon. It is considered an upper class defense helmet.

**Tri Mesh:** It can take a solid hit. The Tri Mesh combat helmet comes with a 1hr oxygen supply. This helmet is atmospheric contained.

**MBA:** The best, but you pay through the nose for it. The commo module range: 45 km. A built in ECM unit produces a -30 modifier vs electronic lock on. The MBA is environmentally contained.

**Bell SS:** Protects the wearer from the deadly effects of sonic disruption. The helmet offers a +30 modifier to SMRs vs sonic based attacks. All residual damage from this type of attack is halved.

**AKMS:** A product of American Konglomerate Corporation. It reduces the effects of sonic attacks by adding a +25 modifier vs this attack form.

**Deshard S:** Another in the Deshard line from the Balshrom Corporation. This unit adds a +40 modifier to SMRs vs sonic attacks.



**Range Master:** The only helmet on the market with long range communications capability, rated at 110km.

**Shalkon MS:** Combat soldiers needed some means to protect themselves from mental attack forms. The Shalkon Corporation developed the first such helmet. This unit adds a +35 modifier to SMR rolls vs mental attack forms. The commo module has a range of 25km.

**Jousen 3:** The best mind-screening helmet on the market. The Jousen provides a +50 modifier to SMR rolls vs mental attack forms.

**Deshard X:** Has an unprecedented threshold for those in its class. The Deshard X also utilizes the best in mind screen technology. If you're in empath territory, this is the helmet to take.

**Goliath:** The epitome of defense helmets!!! The Goliath incorporates a mental screen and sonic technology into one helmet. It provides a +45 modifier to both SMR rolls. The Goliath is environmentally sealed and the commo module has a range of 40km.

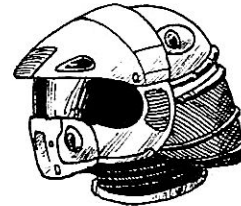

**Defender:** A powerful piece of protection. This item has been tested against LAW rockets and it survives. If you don't want scrambled brains this is for you. Comes complete with mind screen and sonic protection, +45 modifier each. It also contains a long range communications link. Range 68 km.

**TDA (Target/Data Acquisition Helmet):** Provides ranging and lead angle data for targets. All data is visual and audio. The voice command activation sequence adds a +15% modifier to attack rolls. The TDA uses an infrared targeting system. Off world types should invest the money to buy one of these.

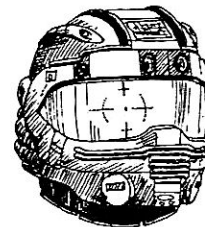

**TDA-2:** Better than the TDA-1. This unit adds a +20 bonus to attack.

## MARS SYSTEMS

The Acronym stands for Military Armament Reaction System. MARS systems are the ultimate achievement in weapons technology. A MARS suit is the same as a conventional suit, but a multiple options package and a thought activated flight system have been added. The flight system has a maximum speed of 200kph, altitude ceiling of 10,000m, climbs at 30m/sec, dives at 50m/second, and has a minimum turn radius of 10m. All MARS systems are environmentally contained.

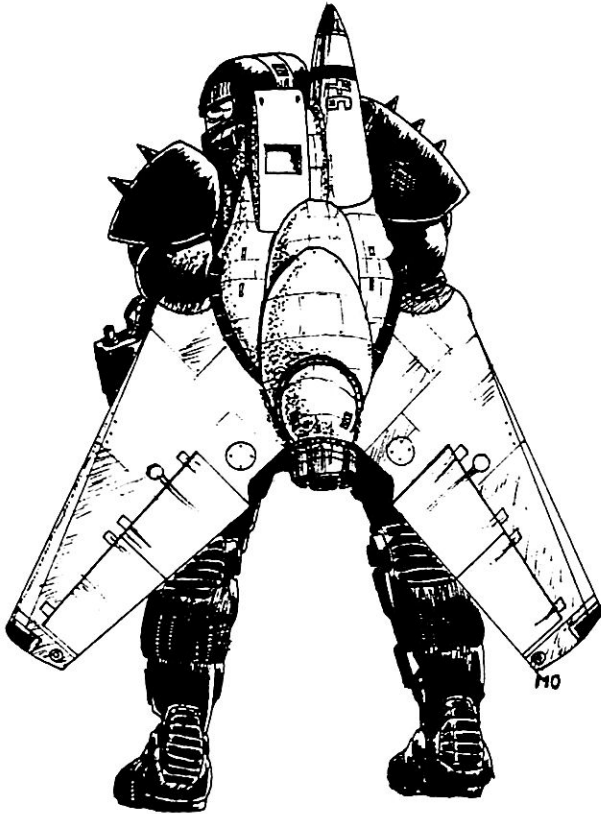

**Guardian:** Comes with 10 Anti-Missile Missiles, an ECM computer rated at 30%, 4 Reflex Missiles, displacement device, and laser shield, mounted on Heavy Assault body armor.

**Warrior:** Comes with 10 AMMs, an ECM computer rated at 15%, flux shield, electromagnetic converter, camouflage unit, infrared dampener, 2 AMM units, and an anti-plas generator, mounted on a MBA chassis.

**Hercules:** Come with a built-in Devastator Omega cannon, 10 Reflex missiles, 20 AMM units, an ECM computer rated at 30%, 10 body flares, anti-plas generator, flux shield, camouflage unit, infrared dampener, laser shield, and a smoke generator, mounted on an improved Argus suit.

**Titan:** Custom designed to the tailored needs of the consumer. Built on a Dreadnought armor chassis. It carries a Crusader gatling laser cannon, holographic generator, an ECM computer rated at 30%, and another 500,000 credits worth of options of your choice.

## TIES

The Acronym stands for Target Independent Engagement Systems. These 360 degree combat systems are designed to allow the soldier to engage a target with automatic systems, then switch quickly to another target. An advanced computer provides a visual display of multiple targets within a specified radius. The owner merely tells the computer to engage the target and the computer acts on the command. The system also functions on automatic priority targeting where the computer analyzes the various potential threats and engages them automatically. The visual display is voice activated. The owner can switch on and off between the display and normal vision by vocal command. Advanced TIE models provide a continual second by second audio/visual playback of events as they transpire. All TIES provide readout of systems functions such as ammunition expired and system malfunctions

TIES are mounted to the back of the armor (chest) and take up 30 units of space.

**MasRock 550:** This unit operates a powerful pulse cannon. The targeting computer is rated at 120% for all ranges. This system can engage a new target every 3 seconds. The MasRock 550 packs enough punch to get the job done. It contains 100 shots. Damage: 10-40 points. Range: 500m radius.

**Argonite 1200:** The Argonite 1200 is designed to wipe out heavy armor. The unit mounts 3 free acting gatling laser cannons that can effectively engage targets out to 1200m. Each cannon can act independently or function together and fires 5 shots per second. The damage yield is 6-36 per shot. The Argonite 1200 targeting computer is rated at 140%. It contains energy for 500 shots.

**Sprinkler:** Called the Burp Gun. Designed by Armament Defense Action Corporation, who also builds the vaunted Bear series armors. The Sprinkler is a neat little toy. It can spray a 50m area with 1,000 20mm high explosive rounds in 2 sec. This unit has 12 free rotating gatling cannons. There is a 200% chance to hit anyone within a 50m radius. The targeted individual is assumed to be hit with 3-18 rounds automatically. Each round reduces AI by 4 points and does 3-18 points of damage. The chance to hit is reduced by 50% per range bracket beyond 1.

**ShadowFax:** Fires a deluxe anti-tank missile which does 4-24HP of damage. The targeting computer is rated at 115%. The unit carries 10 rounds and has a range of 4000m. The ShadowFax can engage a new target every 2 seconds.

**Shadow Master:** This unit carries twin ground to ground missile launchers with a combined 20 round storage capacity. It can fire simultaneously at different targets or together. It has automatic data possessing. Otherwise it is exactly the same as the ShadowFax system.

**Son of SAM:** This unit is designed to engage air units such as combat skimmers, low altitude bombers, helicopters, etc. It can fire up to 4 Surface to Air Missiles simultaneously and contains automatic data processing. The targeting computer is rated at 140%. Munitions: 12. It has a range of 100km, and delivers 6-36HP of damage.

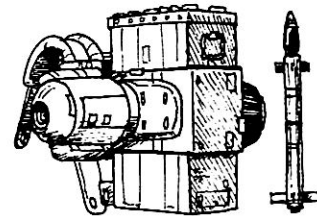

## HIGH-TECH ARMOR OPTIONS

**Ablative Liner:** This is a thin lining designed to protect against lasers. Normally lasers burn straight through the absorption rating of armor. A-liners are inserted between the armor and its absorption polymers. When a laser beam strikes the liner, it acts as an insulator and the laser's heat burns it instead of you. In effect, it works like the normal AR of a body defense suit but acts against lasers. A-liners use 1 space per 4 points of protection.

**AMM:** Fires anti-missile missiles that are designed to take out incoming missiles. The cost is for the radar tracking unit itself. The unit is attached to the shoulder. Each missile costs 2500cr and has a 20% chance to hit an incoming target. Carries 10 missiles.

**Anti-Plas Generator:** This device is strapped to the utility belt (abdominal section). The generator reduces plasma attacks by 10 points.



**Anti-Grav Belt:** Reduces the effects of encumbrance on a person by 40 points. It is designed to assist humanoid types in carrying heavy weapons systems into combat. It is built into the armor.

**Anti-Magnetic Generator:** This system was developed to defeat the effects of Mag Guns. The device de-magnetizes body armor. Any Mag rounds that strike the armor have only a 15% chance to adhere. The generator is built into the chest section of the armor and is permanent.

**Arm Rockets:** Miniature missiles that are attached to the forearm of the suit. They are voice activated and have a 50m range. Arm rockets have a 70% chance of striking their target at all ranges. Damage: 3-18.



**Auto Injector:** Once wounded the Auto Injector is activated injecting a BRI (standard or massive, depending on the extent of injury) into the user. The system will not inject BRI's if the patient has broken bones or other problems which can be aggravated by the use of BRI's. The Auto Injector can hold a maximum of 6 BRI's, which must be purchased separately. It is mounted to the thigh.

**BMH (basic):** Stands for Body Mounted Harness. It mounts directly to the back of a Cizerack cat. It is mechanically activated and fires straight ahead of the cat, allowing her the freedom to move on all fours and still engage enemy units. Because the cat must turn her whole body to fire, a +2 initiative modifier is applied whenever she changes targets. Weapons are automatically considered braced.

**BMH (look and shoot):** Follows the same basic principle as the BMH, except that the gun harness follows wherever the cat happens to be looking. This device makes the cat awesome in open terrain combat. The short reaction time negates the IM penalty of the standard BMH. Abdominal mount.

**Body Flares:** Body Flares are a last ditch effort to stop an incoming heat seeking missile by distracting it with a hotter heat source that is fired away from the target. They have 15% chance to do this successfully. The unit is mounted to the shoulder blades (arm) of the defense suit. Has enough energy for 10 shots.

**Camouflage Unit:** Changes the surface color of the armor to match terrain features (it does not make you invisible). It provides a -30 modifier vs detect concealment attempts when moving and a -50 when standing still. Permanently affixed to the chest of body armor.

**Carrying Case:** Most types of armor are a composite of high-strength, light-weight metal alloys. Nevertheless, they can be bulky and difficult to transport when not worn. Characters attempting to carry a suit of armor move at 1/8th normal movement (if at all). Anti-grav carrying cases are relatively cheap, and a case with a suit of armor in it weighs only 1/8th the normal encumbrance of the armor and has very little bulk.

**Corrosive Protection:** A thin layer of corrosion-resistant material coats the entire suit, adding a +40 modifier to SMRs vs acidic or basic attack forms. Corrosive protection is a permanent option.

**Cryo Option:** Another device that can be purchased to enhance the operation of the Auto Injector system. The Cryo Option automatically injects a cryogenic freeze drug into the body when the person is near death or in a serious coma. It is mounted to the left thigh of the defense suit.

**Displacement Device:** This super sophisticated device allows the wearer to instantaneously displace himself up to 20m from his current position. A built-in discriminator prevents the owner from winding up stuck in a rock or other solid object. The direction of displacement is somewhat random, only 80% effective. A roll of 81 or above indicates that the individual has been transported in a random direction. A d12 is used to determine the clockwise direction. It is mounted in the middle back of the armor suit. The unit contains enough energy to facilitate 20 displacements.

**Drop Bag:** This valuable device has saved the life of many warriors. The removable Drop Bag is mounted on the back of an individual. The unit detects sharp increases in velocity in a vertical direction. It then sends electronic commands to a set of inertial retro-rockets which fire, changing the person's direction with respect to the ground so that he is facing skyward. At the same time, the bag inflates (helium) and the victim lands on it. The device is 85% effective to a height of 40m. Python versions cost three times the list price. It should be noted that sharp objects on the ground will puncture the bag and render it useless. Also, any weapon attack that pierces the rear armor of the person with this device will render the bag non-functional.

**ECM:** Characters can have electronic-counter measures built into their defense suits to reduce the chances of electronic lock-on. The cost is per 01% of ECM modification. A maximum modification of 50% can be achieved.

**Electromagnetic Converter:** Converts electromagnetic energy such as lasers into its kinetic equivalent. A favorite of Mazians everywhere. It is mounted to the utility belt of the defense suit. It contains enough energy to facilitate 60 minutes of operations.

**Environmental Containment:** Seals the suit against the effects of chemical and biological attack forms. It seals the suit from the outside atmosphere. It does not include its own air supply.

**Flotation Device:** Similar to the drop bag, but mounted in the lower abdomen section of the armor. The bag is much smaller, and will not help a falling victim, but will serve to keep someone in armor afloat.

**Flux Shield:** The Flux Shield Generator is the most powerful protective device available in the 23rd Century. The flux shield completely blocks out the effects of kinetic attacks, halves the effects of laser attacks, and reduces the strength of Omega and Plasma weapons on a point for point basis. An undamaged flux shield has 100 points of protection. It recharges at a rate of two points per hour and is mounted to the chest cavity. The unit is so large that nothing else can be mounted to that section. The flux shield contains enough energy for 60 minutes of continuous operation.

**Gills:** Gills are a helmet option. They extract oxygen from water, allowing an individual to breath while submerged in water. Helmet Option.

**Grappling Hoist:** This device is fired from the chest cavity of body armor upon vocal command. The Grappling Hoist uses 100m of Super Flex line, attached to a titanium steel arrow head. The arrow tip imbeds itself in a solid object and the hoist mechanism then raises or lowers the owner at a rate of 1m per second. In desperate situations, the device can be used as a weapon. The tip inflicts 2-8 points of damage, and has a 50% chance to strike someone out to 30m. Chest Mount.

**Grenade Launcher:** Is attached to the forearm. The voice activation sequence has a 150m range. Accuracy: 90/85/65/36/10. It carries 6 rounds in preset order. The magazine must be removed and reloaded to change the order of the munitions. Reloads one grenade every 3 seconds. Damage: By round type.

**Gyro Stabilizer:** Reduces the "kick" generated when weapons are fired on automatic. The penalty for automatic fire is halved. Arm mount.

**Heavy Belt:** A more advanced version of the anti-grav belt which reduces encumbrance by 75, instead of 40.

**Heavy Missile:** Heavy missiles are high-impact rounds that are designed to penetrate the futuristic Heavy Point battle armors. These weapons represent the cutting edge of body weapon system technology. Heavy missiles are fired from a missile rack, mounted on the shoulder of the individual, and possess a heat-seeking guidance system, which is rated at 120% effectiveness. The missiles travel 1000m per sec, and inflict 4-16 HP damage.

**Holographic Generator (body):** It creates up to four, 3-dimensional duplicates of the subject. The images follow the wearer at a random distance out to 5m. Each charge lasts one minute. The subject is illuminated by a small portion of the laser beam, then recorded in memory by reflected laser light. Each duplication drains 1 charge from the pack. The pack holds 20 charges and is mounted in the abdomen.

**Hover Jets:** Allows the wearer to hover or move vertically in the air. Hover Jets have an altitude ceiling of 2000m and a maximum encumbrance of 350. They are mounted to the person's calves.

**Infrared Dampener:** Reduces the chance to be detected by infrared emitting sources by 30%. It is a permanent armor option that is built into the chest of the defense suit.

**Infrared Discriminator:** This device detects the relative heat differences between living objects. A built-in mini-computer then cross-references the thermal signature and relative size to determine what type of creature is being scanned. The system has a 95% chance of successful determination against all known creatures, and has a maximum range of 250m. This system is a helmet option. It can function continuously for 4 hours.

**Insulation (EMP):** EMP insulation protects body armor from the harmful effects of electromagnetic pulses. The insulation is 100% effective. This option is built directly into the armor lining and is permanent.

**Internal Food Processor:** Sometimes referred to as the 'automatic MRE', the internal food processor injects the wearer with a nutritional supplement at preset intervals of time. This allows soldiers operating in hostile atmospheres to 'eat' without removing their helmets. The processor can hold 60 units of food. It is mounted to the face plate of the helmet.

**Jet Pack (T-5):** The jet pack allows the wearer to fly for short distances. The ion powered pack puts out up to 500m/kg of thrust pscm. Turning is accomplished by firing the control thrusters. The T-5 can climb at 17m/s and dive at 30m/s. It has a maximum speed of 240kph. The pack can fly continuously for 3 hours. A weapon can be mounted to the steering bars. Chest Mount.

**Jump Pads:** Designed in the latter part of the 22nd Century. It enables the wearer to leap forward 10m and 5m vertically. It utilizes a short duration anti-grav propulsion system. The system is attached to the feet of the defense suit.

**Kinetic Energy Shield:** The generator creates a force-shield that surrounds the body. The electromagnetic field reduces the effects of kinetic based attacks by five points per attack. The field gives off a bright purple light which can be detected at great distances. It can function continuously for up to 15 minutes. Mounted to the chest or abdomen.

**Laser Shield:** This arm shield is held like a normal shield. Laser attacks that do less than 10 points of damage bounce off the shield and are reflected back in the general direction of the attacker. The shield is 0.7m squared. Any laser that hits the arm with the shield or any other attack roll of 20 or less strikes the shield. Hand Mount.

**Magnetic Disrupter:** This expensive item is purchased to protect against Pulse and Omega weapon systems, both of which use a magnetic bottle to deliver the attack. The damage yield of either attack form is halved. Abdominal/Chest Mount.

**Magnetic Deflection Generator:** Generates a magnetic force-field which deflects incoming metal projectiles. The MDG has an 85% chance to deflect any non-anti-tank metal projectile. This unit cannot be worn with an anti-magnetic generator. Chest Mount.

**Missile Rack:** This platform is mounted on the shoulder of a suit of body armor. The rack has a ten missile capacity (reflex or heavy missiles) and utilizes a recoil suppression system to reduce the effect of back blast. The rack increases the missile's chance to hit by 10%. It takes up 2 units of arm space and 20 units of chest space.

**Mrs. Fusion:** A system power pack that mounts directly into the armor. This light weight device holds 200 power units (see Battle Master's Section Page 221) or "an eternity" of lighting and other electrical charges. Weapons and items that are not armor options can be tied into the Mrs. Fusion for 1000cr. Shoulder Mount (arm).



**Oxygen Supply (6 hour):** This option provides a 6 hour oxygen (or methane) supply for the person wearing the suit. Requires environmental containment.

**Power Rack:** A more advanced version of the missile rack. This rack can carry Spartan anti-tank rounds as well as reflex and heavy missiles. It raises the chance to hit by 17%. Functions like a standard missile rack.

**Protection (absorption):** Absorption polymers may be added to body armor. They take up .25 units of space per point added and have an encumbrance value of 0.1.

**Protection (hydraulics):** Emergency backup lines may be added to body armor. These temporary units are designed to function for 6 hours before breaking down. Backup hydraulic lines take up only half of the total space available for the section. Hydraulic backups cost 10% of the cost of the armor.

**Protection (servos):** The same as hydraulics.

**Protection (system plating):** Armor plating may be added to protect sensitive systems from damage. The plating takes up 1/2 the total space for the unit. System plating reduces the chance of destruction by 40% and costs 250cr per unit of space required. Encumbrance: 1 per unit of space required.



**Quick Sealant Unit:** This system secretes Liquid Iron to fill tears and holes in body armor. The QSU is capable of repairing up to 35 points of armor integrity. Another version of this system can be purchased to seal the tears in an atmospheric liner. The QSU is 85% effective. It is built directly into the armor. Refills cost 100cr.

**Rad-Liner:** Radiation-liners provide protection from exposure to harmful radiation. Confers a +75 modifier against radiation SMRs.

**Radar (360 degree):** This system can track up to 50 targets simultaneously, on the ground or in the air. The range is 10km and effectiveness is 125%. It is a helmet option.

**Reflex Missiles:** Heavy missiles mounted on the shoulder section of body armor. These weapons are thought activated and follow the electronic signature of the target. Once fired, they home in on the target and need no further guidance. Reflex missiles have an 85% chance to hit the target at all range brackets. They have an effective range of 800m and do 6-36 points of explosive damage.

**Scatter Defense Laser Unit:** This powerful one shot unit is used to defeat mass assaults. It is voice activated and fires a high-dispersion laser pattern which automatically strikes any individual within range bracket 1, and in a 60 degree arc to the rear of the user. Anyone in that death zone is struck by 6-24 laser beams, which inflict 3-12 points of damage each. Lower Spine Mount (abdominal).

**Search Light:** Mounted on the helmet. Search lights generate a powerful cone of light out to 75m. The cone is 10m wide at the end. Search lights add +50% to night-time sighting checks within 25m. Assume a 1% reduction per meter beyond the 25m. All detection attempts against individuals wearing active search lights are increased by 100%.

**Shield:** Provides a +50 to parry attempts.

**Skalers:** Pneumatic suction cups, attached to the hands and feet (2 units each). They allow the wearer to ascend or descend smooth surfaces. Skalers don't function well on rocky or rough terrains, as a good seal is required for the cups to function. The suction pumps are activated by voice control. The suction itself, is driven by small pumps. The voice control must be pre-tuned to the owner so as to avoid "Hey suction cups, Release!!!!"

**Smoke Generator:** Automatically dispense smoke when struck by high-intensity light, such as lasers. The smoke spreads at a rate of 4m per second in all directions. Center Spine Mount (chest).

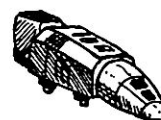

**Suicide Bomb:** If you're going to go, they should be polite enough to join you... This device is a favorite of Phentari, who consider it to be the ultimate DIS (Disrespect)! At the epicenter (the center of explosion), the suicide bomb inflicts 2 HP of damage. The damage yield decreases by 1/2 per 05m of distance. It mounts to the rear of one's helmet and must be activated by a code which is punched in on a wrist band.

**Talons (Retractable):** Voice-activated titanium steel talons spring from the back of each hand and inflict 2-12 points of damage per hit. Hand Mount (arm).

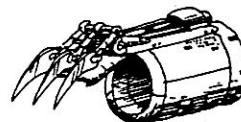

**Thermal Generator:** Creates false thermal images. The mini-computer can be programmed to produce a variety of infrared images, up to size class 8. It is 85% effective. The computer can also be used to enhance the signature of infrared emitting devices by 25%. Abdominal Mount.

**UV Scrambler:** Emits an intense UV strobe light. The effect is to blind all those with any kind of night vision, or night vision device. The strobe has a range of 250m and can operate for up to 100 minutes. Shoulder mounted.

## HAND WEAPONS TABLE

Range Brackets: Denotes the base percentage chance to strike a target at the specified range.

1: 00-05m      3: 16-25m      5: 51-150m      7: 301-750m  
2: 06-15m      4: 26-50m      6: 151-300m      8: 751-2000m

SS: System Shock is the base percentage chance of a weapon surviving undamaged when it is dropped, jarred etc.

ROF: Rate of Fire represents the maximum number of rounds that the weapon can fire per second. Weapons with a rate of fire greater than 1 are assumed to be automatic.

MN: Malfunction Number. A roll of this number or higher indicates that the weapon has malfunctioned. SEE MALFUNCTIONS ON PAGE 222.

Q: The number of rounds or charges that the weapon can hold.

DAM: The amount of damage that each bullet or pulse does per attack.

P: Parry Number. The percentage chance for the weapon to parry an attack.

Cost: The cost to buy this weapon, expressed in credits. If the number is followed by an "M" it means millions of credits.

NOTE!! All weapons, except lasers, lose damage yield at long range. The weapon does 1/2 damage at the last range bracket.

### ARCHAIC HAND HELD WEAPONS

TYPE	1	2	3	4	5	6	7	P	SS	ROF	Q	DAM	COST
Axe (hand)	55	-	-	-	-	-	-	15	35	1/2	-	1-6	10
Axe (throwing)	60	50	00	-	-	-	-	12	35	1/6	1	1-6	24
Bow (compound)	70	60	50	40	20	00	-10	-	32	1/6	1	var	150
Bow (long)	70	60	50	20	10	-10	-	-	25	1/6	1	var	70
Bow (short)	70	60	35	05	-30	-	-	-	20	1/6	1	var	25
Catir	80	-	-	-	-	-	-	05	70	1/3	1	3-9	270
Club	75	-	-	-	-	-	-	12	50	1/2	-	2-7	07
Crossbow (light)	75	65	55	25	05	-20	-	-	40	1/6	1	1-6	55
Crossbow (heavy)	75	65	55	30	15	-05	-30	-	45	1/12	1	2-7	110
Dagger	50	-	-	-	-	-	-	02	100	2	-	1-4	4
Dagger (thrown)	65	45	-10	-	-	-	-	-	100	1/3	1	1-6	15
Doka	65	-	-	-	-	-	-	08	65	1/4	-	2-8	12
Dossien	60	30	-	-	-	-	-	-	30	1/2	-	1-6	10
Flail	65	-	-	-	-	-	-	12	95	1/3	-	2-8	20
Ioken	70	55	25	-05	-25	-	-	-	50	3/12	3	2-12	85
Muadirg			Special						40	1/3	1	2-12	700
Ptfaang	85	-	-	-	-	-	-	25	55	1/3	1	1-8+	70
Quabal	70	65	40	-10	-50	-	-	-	70	1/6	1	2-12	350
Skil	80	60	25	00	-	-	-	-	50	1	1	1-3	200
Spear	80	-	-	-	-	-	-	25	50	1/3	-	1-8	3
Sword (broad)	65	-	-	-	-	-	-	45	85	1/2	-	2-8	30
Sword (long)	75	-	-	-	-	-	-	35	65	1/3	-	1-8	56
Sword (short)	60	-	-	-	-	-	-	30	70	1	-	1-6	40
Sword (2-Handed)	85	-	-	-	-	-	-	15	-	1/4	-	2-12	80
Tieaz	65	-	-	-	-	-	-	01	70	1	-	2-8	60
Toma	95	-	-	-	-	-	-	35	30	1/3	-	3-12	500

### ARCHAIC POWDER WEAPONS

#### PISTOLS

TYPE	1	2	3	4	5	6	7	8	MN	SS	ROF	Q	DAM	COST
S&W .22 Cal.	65	55	40	10	-20	-50	-	-	98	100	1	1	1-6	40
Police .38 Cal	75	70	65	20	-15	-50	-	-	99	100	1	6	2-7	100
Colt .357 mag	70	60	55	25	05	-30	-	-	99	100	1	6	2-8	130
Derringer .44 Cal	68	55	40	05	-30	-	-	-	98	100	1	2	2-8	220
S&W .44 Magnum	68	60	50	20	-10	-50	-	-	100	100	1	6	3-9	245
Colt Anaconda	65	55	35	20	10	-20	-	-	100	100	1	13+1	4-10	425
Walther PPK	77	70	65	34	20	-20	-	-	98	100	3	7+1	2-5	560
Beretta 9mm	78	68	60	35	25	-15	-	-	98	100	3	15+1	1-6	675
IMI Eagle	75	65	58	35	10	-30	-	-	99	100	2	9+1	2-8	800

#### RIFLES

TYPE	1	2	3	4	5	6	7	8	MN	SS	ROF	Q	DAM	COST
Galil A.R.	70	60	40	30	-20	-	-	-	99	100	5	30	1-6	300
AK-57	77	65	55	30	05	-05	-20	-	99	100	3	30+1	2-8	450
M-16A3	80	70	60	40	30	05	-20	-	96	97	3	30+1	2-8	500
FN-FAL	80	75	65	45	20	05	-10	-30	97	100	3	20	3-12	1850
TK-7A	82	70	60	45	35	25	15	05	98	100	3	20+1	3-12	10,000
Barrett 82	105	95	88	77	33	25	15	-05	97	100	1	11+1	4-24	15,000

**SUBMACHINE GUNS**

TYPE	1	2	3	4	5	6	7	8	MN	SS	ROF	Q	DAM	COST
IMI Uzi	80	70	60	35	10	-30	-	-	99	100	4	32	1-6	350
Thompson	63	55	25	00	-35	-	-	-	94	99	4	50	2-7	375
MP5	75	65	55	40	20	05	-20	-	96	100	4	30	1-6	600

**SHOTGUNS**

TYPE	1	2	3	4	5	6	7	8	MN	SS	ROF	Q	DAM	COST
Ithaca	95	60	-10	-	-	-	-	-	98	100	2	4+1	3-12	150
(slug)	80	55	30	-20	-	-	-	-	-	-	-	-	3-9	-
Remington M870	100	72	05	-35	-	-	-	-	97	100	1	5+1	3-12	200
(slug)	85	60	35	15	-	-	-	-	-	-	-	-	2-7	-
Franchi	100	60	15	-35	-	-	-	-	99	100	2	7+1	3-9	375
(slug)	90	60	45	-05	-40	-	-	-	-	-	-	-	2-8	-
Masral 12g	97	65	-10	-45	-	-	-	-	95	100	2	5+1	2-12	550
(slug)	83	50	30	-10	-30	-	-	-	-	-	-	-	3-9	-
Pancor	90	75	40	20	-20	-	-	-	100	95	3	12	3-12	7000
(slug)	90	65	50	30	10	-	-	-	-	-	-	-	3-9	-

**MACHINE GUNS**

TYPE	1	2	3	4	5	6	7	8	MN	SS	ROF	Q	DAM	COST
M-60	80	60	50	40	25	10	-05	-25	97	100	7	250	3-12	3500
PK	84	62	45	33	23	05	-10	-20	95	100	8	150	3-12	5000
XM-214	65	55	37	15	02	-20	-45	-	99	100	18	500	2-7	10,000
LTX-311	80	65	55	33	10	-05	-20	-40	100	100	12	500	2-8	15,000

**AMMUNITION TABLE**

ITEM	COST
Arrow (normal)	5
Arrow (armor piercing)	20
Arrow (explosive tipped)	100
Bolt (normal)	10
Bolt (armor piercing)	35
Bolt (explosive tipped)	120
00 Buck Shot	10
12 Gauge Slug	15
10 Gauge Slug	20
.22 cal	6
.38 cal	7
.357 magnum	12
.44 magnum	15

**ACCESSORIES TABLE**

ITEM	COST
100 Power Scope	300
200 Power Scope	500
400 Power Scope	800
800 Power Scope	1200
Starlight Scope	3000
Infrared Imagery	500
Bow Sight	150
Tripod	20
Silencer	300+

**BEAM WEAPONS****LASER PISTOLS**

TYPE	1	2	3	4	5	6	7	8	MN	SS	ROF	Q	DAM	COST
Mirchaum SSLU	75	65	55	30	00	-	-	-	98	52	1	1	2-7	200
OLC-Pistol	75	72	70	60	25	-	-	-	93	55	1	10	1-6	400
PL-3	78	72	65	58	50	30	-	-	95	80	1	10	1-6	575
BS-2	78	68	60	45	20	-	-	-	98	85	2	10	2-7	800
MC-6	73	70	62	55	35	10	-15	-	94	90	2	10	2-8	2200
Savage-B	75	73	70	60	55	25	-20	-	99	90	3	15	2-8	12,225

**RIFLES AND CARBINES**

TYPE	1	2	3	4	5	6	7	8	MN	SS	ROF	Q	DAM	COST
M16-L	75	75	72	64	58	10	-10	-	98	92	1	30	1-8	5000
M18-L	77	75	71	65	60	25	00	-15	95	97	2	30	2-8	5570
RKM	75	75	70	67	60	40	15	00	99	100	1	50	3-12	18,500
Backshaw	82	82	80	78	30	15	00	-25	98	95	1	20	2-8	20,000
Toshoni LL-C	95	90	85	50	25	-20	-40	-	99	99	2	20	2-8	20,000
Tagert-6	70	68	60	55	50	30	10	-05	96	99	2	50	2-12	25,000
Micron	80	78	73	70	68	45	20	-05	97	97	3	50	2-8	25,000
Arrow LOSN	100	95	90	85	80	75	48	30	100	99	1	30	3-12	25,000
Shalkon	80	76	70	67	20	00	-	-	99	94	2	-	2-12	40,000
Alpha 2	85	85	80	75	70	50	20	10	98	98	1	100	var	50,000
Beta 3	85	85	82	78	75	50	30	20	99	99	2	100	var	80,000
Falcon XR-7	92	90	85	80	75	42	25	10	97	97	5	150	2-12	200,000
Gamma 4	85	85	82	78	75	50	30	20	99	99	4	200	var	250,000
Calsham 4	90	90	88	85	80	75	50	35	100	100	4	50	4-16	500,000



Equipment Chart

**IMPACT LASERS**

TYPE	1	2	3	4	5	6	7	8	MN	SS	ROF	Q	DAM	COST
Lancer	100	95	90	86	78	72	50	32	99	98	1	50	4-24	0.75M
Crusader	90	85	80	72	66	55	32	14	98	96	1	50	6-36	1.5M
Excellior	95	90	86	80	70	54	35	14	99	99	1	100	6-36	2.0M

**MACHINE GUN LASERS**

TYPE	1	2	3	4	5	6	7	8	MN	SS	ROF	Q	DAM	COST
Valley Green	90	88	85	80	75	70	65	35	100	99	12	500	5-20	4.5M
Shalkon Heavy	90	90	90	85	78	75	60	40	97	99	15	500	6-36	6.5M

**PULSE CANNONS**

TYPE	1	2	3	4	5	6	7	8	MN	SS	ROF	Q	DAM	COST
PC-3	85	15	-30	-	-	-	-	-	98	55	1	25	3-18	16,500
PC-6	65	32	00	-50	-	-	-	-	98	70	1	25	3-18	18,000
M-20 Blaster	77	55	20	00	-30	-	-	-	97	85	1	25	4-24	20,000
Mentar	75	45	25	-10	-40	-	-	-	95	85	2	25	5-30	25,000
RP-4 Masher	82	72	10	-20	-55	-	-	-	97	85	1	25	5-30	50,000
Vector 1	85	65	40	20	00	-20	-40	-	95	90	1	50	3-18	80,000
BC-Engager	87	60	30	15	-05	-20	-	-	97	97	1	50	var	100,000
Vector 3	89	70	50	25	05	-15	-30	-	97	92	2	50	3-18	150,000
BC-Enforcer	87	60	30	15	-05	-20	-	-	99	96	2	50	var	200,000
Vector 4	89	70	50	25	05	-15	-30	-50	99	94	2	50	4-24	200,000
Mentar-A3L	80	52	30	-05	-30	-60	-	-	95	88	4	50	6-36	250,000
BC-Destroyer	89	68	40	20	-10	-40	-	-	100	99	3	60	var	0.5M
BC-Terminator	89	68	45	25	05	-20	-	-	99	98	4	120	var	1.0M
M-80	80	65	50	40	15	-25	-45	-	99	90	4	100	5-40	3.8M

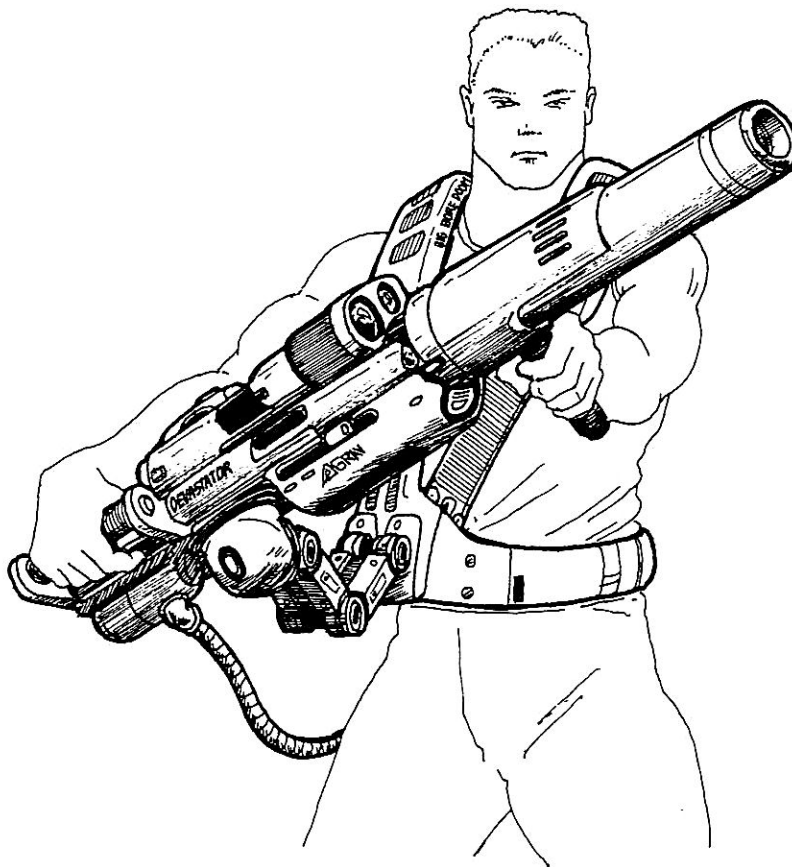

**OMEGA WEAPONS**

TYPE	1	2	3	4	5	6	7	8	MN	SS	ROF	Q	DAM	COST
OC-1	70	30	00	-55	-	-	-	-	93	88	1	25	4-24	35,000
Balshrom FC	75	40	10	-40	-	-	-	-	97	92	1	25	4-24	42,000
Valley Green OX	70	45	15	-30	-50	-	-	-	97	90	1	25	5-30	55,000
Able 3	85	55	30	-10	-40	-	-	-	97	94	1	25	6-36	100,000
LS-21	80	50	30	-10	-40	-	-	-	93	94	1	25	8-48	120,000
Able Ram	85	55	35	-05	-45	-	-	-	92	90	2	40	7-42	250,000
Viper XM1	90	80	30	05	-30	-50	-	-	98	94	2	50	3-24	275,000
Balshrom 2	100	80	30	-10	-50	-	-	-	97	98	3	50	4-24	300,000
Cobra XM2	95	70	25	-05	-30	-45	-	-	99	99	3	50	4-24	325,000
Python XM3	80	40	20	-20	-50	-	-	-	97	98	1	50	6-60	1.0M
Devastator	90	60	30	00	-45	-	-	-	99	99	2	50	8-80	2.0M

**PARTICLE BEAM WEAPONS**

TYPE	1	2	3	4	5	6	7	8	MN	SS	ROF	Q	DAM	COST
AM1	70	45	00	-50	-	-	-	-	96	93	1/3	30	1-8	10,000
Cheetah	80	60	45	05	-45	-	-	-	97	97	1/3	20	2-8	25,000
Tiger	82	65	50	15	-15	-	-	-	99	99	1/3	30	2-12	60,000
Mark 3	85	60	40	20	00	-20	-40	-	99	99	1/3	30	3-18	127,000
Lion	85	70	50	35	10	-25	-50	-	99	99	1/2	30	3-18	160,000

**METAL GUNS**

TYPE	1	2	3	4	5	6	7	8	MN	SS	ROF	Q	DAM	COST
BC-Render	90	90	80	40	-30	-	-	-	99	92	1/3	20	1	20,000
BC-Shredder	85	80	70	15	-40	-	-	-	99	95	1/3	40	2	40,000
TR-9B	90	90	70	30	-10	-40	-	-	100	100	1/3	30	4	95,000
Parabellum	90	88	77	25	-05	-30	-	-	100	100	1/3	25	8	200,000
Calsham MG	110	90	85	40	10	-20	-	-	100	100	1/3	40	20	1.5M

**MAG GUNS**

TYPE	1	2	3	4	5	6	7	8	MN	SS	ROF	Q	DAM	COST
Stick Gun	70	60	25	-10	-30	-	-	-	94	78	1/6	5	var	30,000
Deliverance	80	72	55	40	10	-05	-25	-	97	95	1/3	10	var	49,000
Metal Man	82	70	61	45	25	10	-10	-25	98	93	1/6	5	var	55,000
Magnatron	87	75	60	55	34	15	00	-20	99	96	1/3	10	var	70,000
Carousel	80	68	52	30	15	-03	-18	-	96	96	1/2	20	var	100,000

**PERSONAL MISSILE SYSTEMS**

TYPE	1	2	3	4	5	6	7	8	MN	SS	ROF	Q	DAM	COST
Ballistic-8									95	90	1/20	1	var	32,000
Pershing 2									96	88	1/20	1	var	50,000
Minuteman									97	89	3/30	3	var	75,000
GTL									99	99	12/60	12	var	95,000

**MAG GUN MUNITIONS**

TYPE	COST
Absorption Destroyer	7000
Acid	800
Audio/Visual Broadcast	11,000
Biological	5000
Chemical	15000
Dummy Round	200
EMP	25,000
Floric Acid	1500
Infrared Strobe	2500
Planar Explosive	12,000
Position Broadcast	900
Radar Enhancement	300
Rubber	1400

**TYPE**

Shaped Charge  
Smoke Generator  
Sunder  
Super Sonic Pulse  
UV Strobe

**COST**

3500  
350  
500  
5500  
5000

**PMS PAYLOADS**

**TYPE**  
High Explosive  
Kill Master  
Radial  
Biological  
Chemical

**COST**  
5000  
23,000  
31,000  
30,000  
30,000

**PMS GUIDANCE****TYPE**

Standard Guidance  
Heat Seeker  
Radar  
Ion Controller  
Supremacy  
Supremacy 2  
Impervious

**COST**

2500  
4500  
10,000  
23,500  
15,000  
18,000  
30,000

Equipment Chart

**DISRUPTORS**

TYPE	1	2	3	4	5	MN	SS	ROF	Q	DAM	COST
Neutralizer	90	20	-40	-	-	95	49	1/6	20	4-24/1-8	25,000
K-4	90	40	10	-30	-	99	75	1/3	20	4-24/3-12	45,000
Majestic	95	45	05	-25	-	98	85	1/3	40	4-24/3-18	60,000
Majestic 2	97	50	15	-20	-	99	90	1/3	40	4-24/3-18	70,000

**DISINTEGRATORS**

TYPE	1	2	3	4	5	MN	SS	ROF	Q	DAM	COST
Duster	90	80	30	-05	-	93	85	1/3	25	20-80/10-40	125,000
Gashil	105	40	05	-50	-	98	98	1/3	25	20-80/10-40	110,000
Americas	90	60	40	00	-50	100	97	1/3	25	40-160/20-80	0.5M
NE-7 Comrade	115	75	15	-30	-	100	100	1/3	50	40-160/20-80	0.5M
Rommel	90	50	00	-50	-	100	100	1/2	50	80-320/40-160	2.5M

**MESON CANONS**

TYPE	1	2	3	4	5	6	7	8	MN	SS	ROF	Q	DAM	COST
Accelerator	80	55	20	-30	-	-	-	-	97	95	1	20	4-48	22,500
Henderson	82	60	30	00	-20	-	-	-	100	92	2	20	4-40	25,000
Emissions	80	65	47	05	-35	-	-	-	98	60	1	25	5-50	32,500
Pulsar	90	80	60	30	10	-15	-35	-	100	100	2	40	20-120	320,000
Quasar	80	70	55	35	10	00	-10	-30	100	100	2	40	8-96	350,000

**FLAMETHROWERS**

TYPE	1	2	3	4	5	6	DUR	MAX	MN	SS	ROF	Q	DAM	COST
A-2	110	70	30	-05	-	-	5	35	100	99	1	10	2-12	500
ME2E1-9	105	80	55	15	-35	-	10	75	96	97	1	100	var	2500
ME2E1-9B	120	100	60	40	-10	-	10	60	94	97	1	50	4-16	4000
Blazer	100	90	60	40	05	-	15	120	100	100	1	100	4-16	7000

DUR: Denotes the maximum duration of flame in seconds. After this time the flamer must cool for 3 sec.  
 MAX: Denotes the maximum range of the flame.

**ROCKET LAUNCHERS**

TYPE	1	2	3	4	5	6	7	8	MN	SS	ROF	Q	DAM	COST
Belair	85	70	40	25	-05	-	-	-	98	97	1/18	1	1-6/4-24	10,000
Steiger 3	87	85	80	55	30	10	-50	-	100	100	1/27	1	2-8/6-36	40,000
Zandovich	80	60	50	40	20	-20	-	-	100	100	4/30	4	2-8/6-36	50,000

**ANTI-TANK WEAPONS**

**TANK RANGE BRACKETS**

- 1) 01-50m
- 2) 51-150m
- 3) 151-250m
- 4) 251-500m
- 5) 501-1000m
- 6) 1001-2000m
- 7) 2001-3500m
- 8) 3501-5000m

TYPE	1	2	3	4	5	6	7	8	MN	SS	ROF	Q	DAM	COST
Panzerfaust	80	-	-	-	-	-	-	-	99	100	1/90	1	30-120	5000
Bazooka	80	70	10	-	-	-	-	-	97	97	1/60	1	10-60	9000
LAW	83	60	40	10	00	-	-	-	95	98	1	1	10-80	1500
RPG7-B	84	74	50	25	-	-	-	-	99	100	1/15	1	10-60	5700
Dragon	88	80	65	50	25	10	-15	-	97	92	1/60	1	2-8HP	35,000
TOW	95	85	75	60	40	20	10	-25	99	95	1/60	1	3-12HP	60,000
Figlini	97	82	75	62	30	10	-10	-	99	100	1/45	1	4-16HP	80,000
PLG	110	100	90	75	50	35	20	-05	98	100	1/60	1	4-24HP	165,000
Bonoir	102	100	97	80	70	50	37	10	100	100	4/30	1	6-36HP	250,000
HAW-4	94	92	85	70	60	50	10	-08	100	100	1/90	1	8-48HP	300,000

\*NOTE! Anti-Tank weapons are not designed to be used against personnel. If used against anything smaller than a pickup add a -40 to -80 penalty to hit.

**MORTARS****MORTAR RANGE BRACKETS**

1: 01-50m 3: 151-250m 5: 501-1000m 7: 2001-3500m  
 2: 51-150m 4: 251-500m 6: 1001-2000m 8: 3501-5000m

Type	1	2	3	4	5	6	7	8	MN	SS	ROF	Q	DAM	COST
M29	-	50	65	50	20	00	-	-	97	99	1/6	-	spec	1200
M110	85	70	55	20	00	-20	-	-	98	99	1/4	-	spec	4500
M210	-	-	45	70	65	35	05	-10	99	99	1/6	-	spec	10,000
Pincheau ML2	-	25	55	75	70	40	15	00	100	97	1/6	-	spec	20,000
Pincheau ML3	-	32	62	82	77	45	20	05	98	97	1/2	10	spec	35,000
MOR-1	-	47	78	95	90	62	35	22	97	98	1	15	spec	75,000
MOR-3	-	47	78	95	90	62	35	22	100	99	1	20	spec	100,000
MOR-4	-	47	78	95	90	62	35	22	100	99	1	20	spec	150,000

**MORTAR ROUNDS COST**

81mm	200
110mm	350

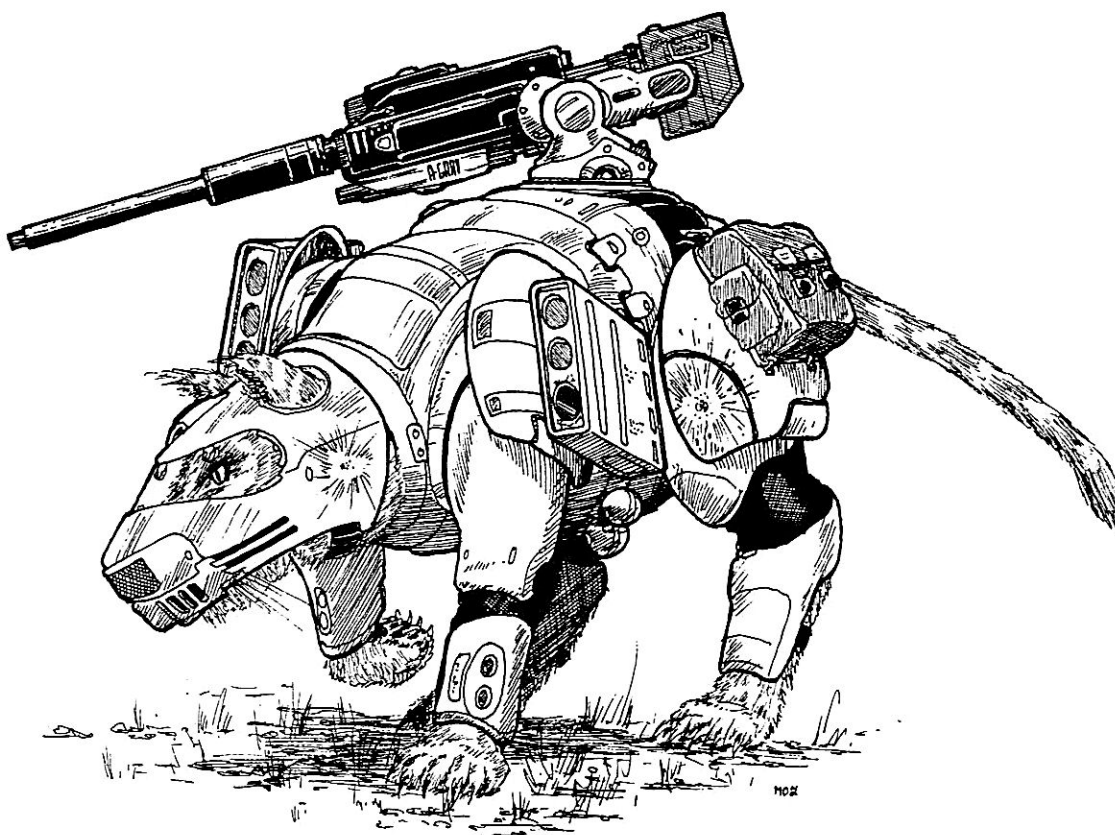
**SPECIALIZED WEAPONRY**

Type	1	2	3	4	5	6	7	8	MN	SS	ROF	Q	DAM	COST
Taser	70	-	-	-	-	-	-	-	99	90	2/3	20	stun	1000
Sonic Disruptor	70	45	00	-50	-	-	-	-	99	80	2/3	20	var	9000
Energy Mace	65	-	-	-	-	-	-	-	100	100	1/3	-	3-12	50,000
Light Sword	75	-	-	-	-	-	-	-	100	100	1/3	-	2-12	60,000

**GRENADE LAUNCHERS**

Type	1	2	3	4	5	6	7	8	MN	SS	ROF	Q	DAM	COST
M-203	75	75	50	20	00	-	-	-	99	98	1/3	1	var	400
M-75	80	75	55	26	00	-	-	-	100	100	1/2	6	var	3500
M-L50	85	85	60	30	00	-45	-	-	100	98	1/3	1	var	5000
Turbo Plus	80	78	65	25	-05	-50	-	-	98	97	2	12	var	50,000

## Equipment Chart

### GRENADE TABLE

TYPE	DAM	COST
M-75 (frag)	1-4/2-12	50
M-85 (frag)	1-6/2-12	70
M-95 (frag)	2-8/2-12	135
Plasma Grenade	4-16/3-18	1000
Super Plasma	4-24/4-24	5000
Plasma Seduction	6-36/8-48	20,000
Molotov Cocktail	Fire	5
P-4	2-8/2-8	150
T-3	Biological	4000
CS-7	Special	70
M-80	Smoke	50
M-90 (concussion)	1-4/3-18	150
Omegaton	3-12/60-360	50,000
BX-1	Biological	5000
CR-3	Chem	5000
M-202	2-5/2-9	200
M-205	1-4/2-9	150
M-206	Biological	700
M-207	Chemical	550

NOTE!!! The first set of numbers represents the damage done by each fragment, while the second represent concussion damage. Within 2m of the explosion, concussion damage is real. Beyond 2m, it is temporary (stun) damage.

### MINES

TYPE	DETONATOR	DAMAGE	COST
Bouncing Betty	P	2-8/1-6	220
Chemical	P	Special	3000
Claymore	E	2-12/3-18	150
Claymore 3	E	3-18/3-18	500
E4	P	4-16 HP	17,000
Light Mine	P,R	Special	450
Needler	P,R	1/2-8	2000
Nuclear	R	Special	1.5M
Plasmore	E,P	4-24/4-24	5000
Sonic	P,R,S	Special	3000
Tangler	P,R	Special	500

### EXPLOSIVES TABLE

TYPE	DET	UNIT	DAMAGE	COST
Dynamite	F,E	Stick	2-24	400
C-4	E,R	Putty	4-48	2000
Jellnite	R	Jell	10-100	8000
Nitro-7	E	Liquid	40-160	10,000
Villanite	R	Putty	50-300	8000

### DETONATORS

TYPE	COST
Multi-Step	100
Plunger	75
Radio	200
Sonic	500
Timer	20
Electronic	100
Fuse	1

### DETECTION EQUIPMENT

ITEM	COST
Binoculars	25
Binoculars (infrared)	1000
Binoculars (long range)	50
Binoculars (night vision)	5000
Binoculars (wide angle)	50
Bio Scanner	7000
Bug Finder	500
Bug Killer	1500

### ITEM

ITEM	COST
D3-A Scanner	25,000
DD-48 Vaporizer	1000
Goggles (IR)	150
Goggles (UV)	100
Infrared Spotlight	500
Metal Detector	200
Mood Discriminator	3000
Motion Detector	10,000
Plastic Explosive Detector	2500
Pocket Jammer Detector	1000
Radar Detector	5000
Sonic Amplifier	1000
Sonic Discriminator	4000
Transmission Jammer	10,000
UV Flare	1500
Vibro Rod	7000



### ESPIONAGE EQUIPMENT

ITEM	COST
Acidizer	700
Blow Torch	35
Cam Flybot	25,000
Camera 35mm	150
135mm lens	115
110-440mm lens	200
28mm lens	90
70-220mm lens	120
Contact Microphone	75
Electronic Tracer Device	250
EV-1 Mole	20,000
Infrared Dampener	10,000
Jump Pads	10,000
Lock Picks (basic)	200
Lock Picks (electronic)	2000
Lock Picks (professional)	600
Mini Camera	1000
Mini Scanner	1200
Mini Video Camera	3500
Pocket Signal Detector	200
Pry Bar	10
Wire Cutters (professional)	80
Wireless Remote Mini Cam	7000
Wrist Torch	200
X-ray Camera	15,000
X-Ray Video Camera	25,000

**EMERGENCY MEDICAL GEAR**

ITEM	COST
Biological Redox Agent	30
Blood Transfusion	40
Body Cart	30,000
Body Rehabilitation Injection (BRI)	100
BRI (massive)	500
Chemical Redox Agent	300
Coolant Injection	225
Cryo Injection	10,000
DNA-6BMR	1000
First Aid Kit	20
Isolation Bag	1000
Methane Injection	500
Paramedic Kit	15,000
Perception Injection	300
Radiation Treatment Serum	600
Rage Injection	500
Reflex Tablet	700
Regeneration Serum	50,000
Storage (medical)	5000
Surgical Kit(portable)	5000
Truth Serum	5000
White Count Injection	150

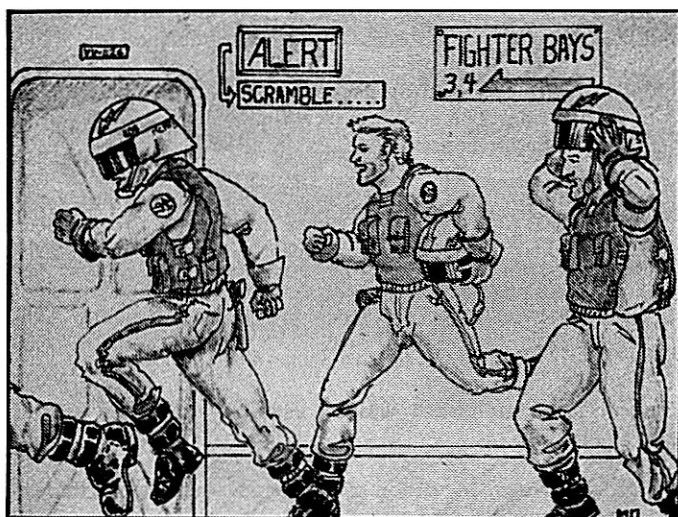
**PERSONAL EQUIPMENT**

ITEM	COST
Atmospheric Processor	5000
Backpack	40
Body Computer	12,500
Brain Scratcher	30
Case (magnetic proof)	120
Case (shock proof)	75
Case (super)	250
Case (water proof)	30
Chem Lab (portable)	700
Compass	7
Compass (digital)	100
Compass (magnetic)	15
Dummy (practice)	500
Emergency Transmitter	100
Flare Gun	75
Flashlight (normal)	5
Flashlight (theadrer)	12
Grapple Gun	75
Grappling Hook	15
Grenade Scoop	25,000
Holo Generator (v)	45.2M
IFN	300

ITEM	COST
Mega Glue	20
P-Cabin	5000
Parachute (military)	900
Parachute (professional)	1500
Phent Morsels	25
Pitons (20)	25
Plasma Generator	250,000
Pneumatic Saw	170
Polymizer (heavy)	250,000
Polymizer (portable)	100,000
Purification Tablets (food)	10
Purification Tablets (water)	8
Raft: 2 man	100
Raft: 4 man	225
Raft: 6 man	400
Range Finder	8000
Refrigerator (portable)	125
Repellant (bug)	10
Rope 20m	10
Rope (flex) 20m	50
Satchel	10
SCUBA Equipment	350
Shark (J-7)	4000
Sleeping Bag	80
Sleeping Bag (arctic)	140
Sleeping Bag (methane)	500
Still (portable)	900
Stove (portable)	100
Tablets (protein)	50
Tablets (salt)	3
Tent: 2 man	110
Tent: 4 man	225
Tent: 8 man	350
Thwack'em Stick	500
Tool Kit	100
Tool Kit (electronic)	15,000
Tool Kit (ionization engineer)	5000
Tool Kit (masters)	500
Web Gear	40

**ENVIRONMENTAL HAZARD GEAR**

ITEM	COST
Chemical Alarm	125
Chemical Goggles	200
CS-4 Chemical Suit	325
CS-7 Chemical Suit	600
Decon Kit	500
E-Tent	25,000
Filter Mask	100
Geiger Counter	400
Gloves (protective)	2
GM-4 Gas Mask	250
GM-7 Gas Mask	425
Hot Bath	15,000
Identification Tape	15

**COMMUNICATIONS EQUIPMENT**

ITEM	COST
Ear Transceiver	150
Radio (hand)	70
Radio (traveler)	150
Radio (field)	500
Radio (base)	1200
Radio (long range)	4000
Radio (interplanetary)	40,000
Radio (interstellar)	4.5M
Shoe Phone	400
Watch Phone	500

## HAND WEAPONS

Hand held weapons are a necessity to the 23rd Century warrior. They are his bread and butter, allowing him to react appropriately to the combat situation at hand. In the 20th Century, the rifle was the primary tool of the infantry soldier. Although some races have introduced other weapons, little has changed. A proper mixture of weapons can mean the survival or extermination of a character. Some races are virtually incapable of using certain types of weapons. For example, the Python Lizard and Ram Python have very short range eyesight and can only clearly distinguish between man sized objects at a distance of 17m and 25m respectively. Consequently, neither Python race uses beam weapons. They choose archaic hand weapons, Pulse Cannons, or Disintegrators instead. Player characters choose whatever weapons they want, but it won't be my fault if you get reduced to space dust because of your own stupidity. Battle Masters should stick to the general rulings on Non Player Character preferred weaponry. The following tables provide you with a composite listing of available weapons. The weapon descriptions are listed categorically.

Oh, by the way, I just thought I had better tell you that pulse cannons, disintegrators, flamethrowers and Omega cannons use backpacks which are extremely heavy! In all seriousness, you can't engage in maneuvers such as high crawls, low crawls, or acrobatics when wearing body mounted weaponry. Swimming while wearing body mounted weaponry is probably a bad idea too.

Restrictions: Python Lizards, Ram Pythons, and Cizerack don't use pistols, due to the inherently large size of their paws. They have difficulty aiming these weapons and suffer a 30 point penalty when firing them. Mutzachans can not use energy based weapons, unless these weapons are specially insulated. Insulating a weapon is expensive and costs 1.5 times the list price.

Restriction: Different races uses different trigger mechanisms. Any person attempting to use a weapon from an anatomically different race fires at a -30 penalty.

## ARCHAIC HAND WEAPONS

Archaic hand weapons are primitive cutting/thrusting/crushing weapons which rely on muscle power to inflict damage. They do normal damage to flesh and body armor. Generally speaking, archaic hand weapons are far inferior to their modern counterparts, doing less damage on the average and requiring the individual to be at close proximity with the enemy. They do, however, have some very important uses. The most obvious is that they don't make much noise when employed. Persons requiring stealth and surprise should recognize the value of these weapons. These are an Eridani favorite.

**Axe (hand):** Archaic weapon used to cut wood. Less than 40cm in length. It doesn't do much damage, but it is cheap. Encumbrance: 1.

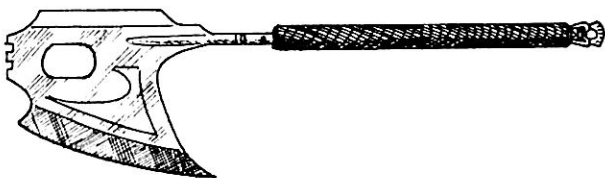

**Axe (throwing):** During the middle ages, individuals on the planet Earth experimented with the concept of a throwing axe. The weapon maker balanced it, placing the fecund within 8cm of the blade. It is a good weapon at close range. Effective Range: 25m. Encumbrance: 2.

**Bow (compound):** With the advent of technological revolution in the early 1900's, the normal bow was heavily altered to this type of design. The compound bow operates with a mechanical pulley system. The drawstring tension is heavy, making the weapon quite powerful. Effective Range: 330m. Encumbrance: 10.

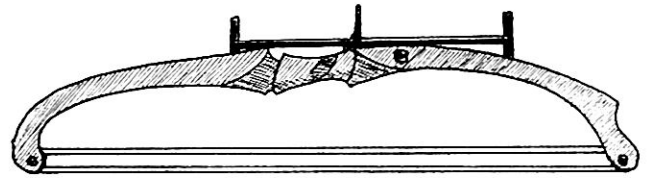

**Bow (long):** An improved version of the bow. The body is longer, usually around 1.2m, providing for greater drawstring tension. The increased tension greatly enhances the range of this weapon. Long bows are the favorite weapon of pre-industrial cultures. The disadvantage when compared to the short bow is that the user is more vulnerable when firing the weapon. Effective Range: 200m. Encumbrance: 8.

**Bow (short):** A favorite weapon of many primitive cultures on Earth. The bow was used primarily as a hunting weapon and is a favorite of many assassin types. There exist a wide variety of attachments that improve the accuracy of this weapon. Effective Range: 150m. Encumbrance: 5.

**Catir:** A 1.5m long, double bladed axe. The Catir traditionally has feathers fixed to the shaft, directly below the fecund. This allows the Eridani to distract the enemy while attacking, adding +10 to parrying and feint attempts. +3 Initiative modifier. Encumbrance: 8.

**Club:** A heavy stick, usually thicker on one end than on the other. Also called a cudgel. A spike can be added to increase damage yield by 2 points. Encumbrance: 7.

**Crossbow (light):** A reinforced bow that is fixed transversely on a stock. The string is released by a trigger mechanism. Crossbows fire every 2nd hand to hand melee segment. Effective Range: 250m. Encumbrance: 7.

**Crossbow (heavy):** A heavier version of its smaller cousin. Better range and damage yield. Effective Range: 400m. Encumbrance: 12.

**Dagger:** A small bladed weapon used for cutting or stabbing. Encumbrance: 1.

**Dagger (throwing):** A version of the dagger which can be thrown. Effective Range: 20m. Encumbrance: 1.

**Doka:** An ancient Phentari weapon. It consists of a 1m long stick, attached to a series of six chains. The chains are linked to balls. The weapon is whirled in a circular motion. The wielder then strikes out with the Doka against the enemy. Using the Doka incurs a +3 to initiative rolls, but those who try to parry this weapon do so at a -20 penalty. The chain tends to wrap around the parrying weapon and strike anyway. Encumbrance: 8.

**Dossien:** This Mutzachan weapon is made of wood. The Dossien is a triangular shaped device that is thrown with a flicking motion, much the same as a frisbee. The razor sharp metal fittings are set into two of the three edges, providing aero-dynamic stability. The third side is held. The weapon returns to the thrower if nothing is struck. The Dossien flies an inordinate distance for its design. Range: 14m. Encumbrance: 2.

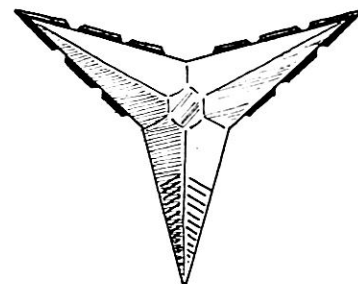

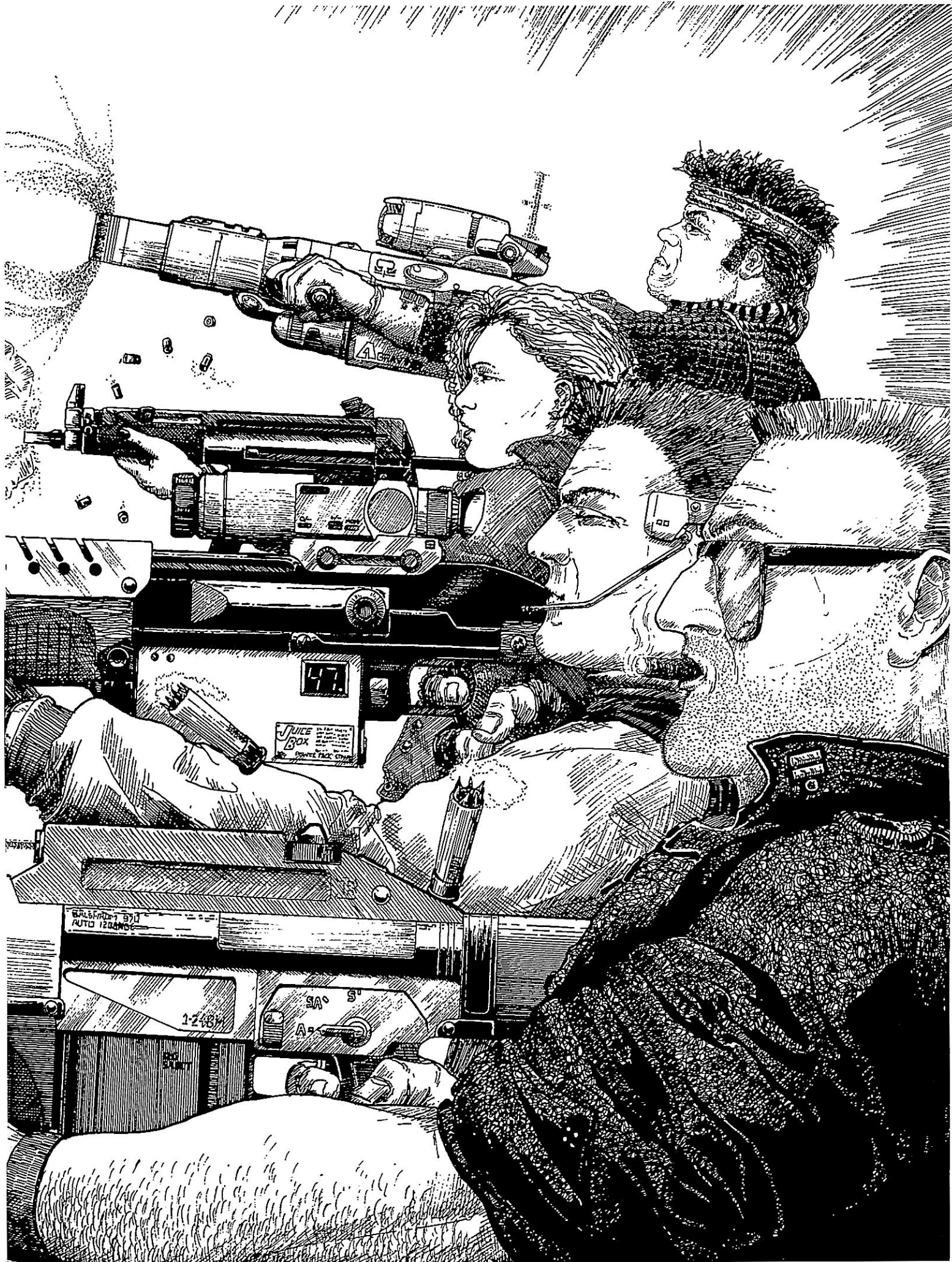



## Hand Weapons

**Flail:** A weapon designed originally as an instrument for threshing corn. By the Middle Ages, it had evolved into a weapon of war. A flail consists of a chain with a ball attached to the end of a stick. The user incurs a +2 penalty to initiative dice rolls, but anyone who attempts to parry a flail attack does so at -15. Encumbrance: 7.

**Ioken:** Used by the Ram Pythons as a hunting weapon. It is a huge crossbow capable of firing all 3 bolts in a single combat round. The drawstring is made out of coronite, a flexible steel alloy found only on the planet Pythos. Effective Range: 85m. Encumbrance: 20.

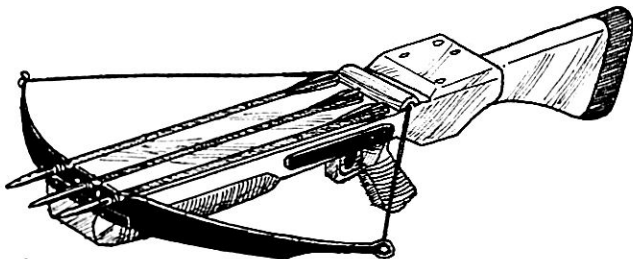

**Muadirg:** Once an Eridani hunting weapon. The Muadirg is a 4 balled bola with spikes. It can be effectively thrown up to 1/4 one's strength in meters (treat as a hand grenade with a -10 to all dice rolls). The weapon also has a 20% base chance to entangle the victim if a hit is made (add in throwing skill modifier). Encumbrance: 4.

**Ptfaang:** The Phentari version of the spear. It is about 2m in length. The head of the weapon sports a blade that is constructed of four separate pieces of metal which fit closely together. When a button is pushed, the blade pieces (called shelin) open into a fan shaped configuration, exposing the hidden barbs underneath. The Phentari strikes with the weapon, aiming for the mid-section, and upon penetration pushes the button, opening the shelin. The blades gouge out the internals of the victim, making the Phentari happy! Re-setting the Ptfaang takes 3 hand to hand melee segments. Example: The Phentari attacks a Gen-Human and the Ptfaang strikes the arm. He chooses not to open the shelin. The weapon does spear damage, 1-8 points. On the next attack, he strikes the Gen-Human in the abdominal region, then releases the fan mechanism. He does 1-8 points of damage plus an additional 1-4 points of twisting damage. Encumbrance: 10.

**Quabal:** Quabals are impact explosive shuriken-like devices. They can be thrown up to 1/3 of one's strength in meters. Quabals do 2-12 points of explosive damage. Fragmentation damage is negligible. Quabals can only be purchased on an Eridani planet or on the Black Market. One is tempted to ask the question: If Eridani are so honorable, why are they carrying these lovely items? Encumbrance: 1.

**Skil:** The Phentari equivalent of a ballistic knife. A button is pressed on the base of the shaft, firing the blade. It is quite powerful and easily concealed. A Skil can also be used as a normal knife. Encumbrance: 1.

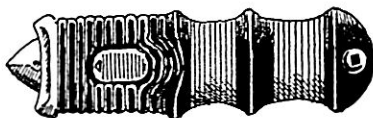

**Spear:** Put a dagger on the end of a pole and you have spear. Crude but effective. Encumbrance: 6.

**Sword (broad):** A medium weight sword with a wide, flat blade. It is normally about 70cm in length. Encumbrance: 6.

**Sword (long):** A longer version of the short sword. It is slightly thinner and has a better parry rating. Encumbrance: 6.

**Sword (short):** A light weapon, about 50cm from pommel to tip. The short sword was primarily used by the Roman legions during the Middle Ages. Encumbrance: 4.

**Sword (two handed):** One must have a 70+ strength score to wield this weapon. It is slow to hit (+4 to attack initiative rolls), but does tremendous amounts of damage. Python class beings incur no initiative penalty. Encumbrance: 15.

**Tieaz:** A small, three blade knife, used by the Zen Rigeln before the Abolition of Pain Decrees in 2040 B.C. Effective Range: 5m. Encumbrance: 2.

**Toma:** The Python Lizard version of a trident. The Toma generally has barbed fishhooks cut into the five pronged fork. This weapon is carved from coral. Encumbrance: 7.

## ARCHAIC POWDER WEAPONS

Archaic powder weapons were the handguns of the 20th and 21st Century on the planet Earth. Since none of the other races developed gun powder, no weapons other than those used on the planet Earth are listed. Powder weapons do normal damage against light body armor. They are still quite useful, though long outdated. FACT: Due to the strict regulations barring the indiscriminate sale of arms to non-evolved societies, archaic powder weapons are quite prolific.

They are short to medium range weapons with a fair damage yield. All archaic powder weapons are assumed to use armor piercing rounds. Teflon coated rounds are able to penetrate armor, whereas normal lead tipped rounds simply mushroom on impact.

If a machine gun is fired from the standing position, there is a greater tendency for it to jam and its accuracy is reduced. The base percentage chance to hit is reduced by 15 points and the malfunction number is lowered by 07 points.

Shotguns have double the threshold of the target's armor subtracted from damage dice. This reflects the spread of the weapon.

Example: Henry the Mutzachan fires at a Cizerack. The Cizerack is wearing AKM armor. Six points are subtracted from damage results before the absorption is affected.

Shotgun hits reduce armor integrity by two points. Shotguns may also be sawed off. Sawed off shotguns add a +20 to hit at range brackets 1-2, but can't be fired beyond range bracket 2. This also reduces encumbrance by 3, and eliminates the snap shot penalty in range brackets 1 and 2.

Pistols can not be effectively used by Ram Pythons, Cizeracks, and Python Lizards due to the size of their hands. Anytime one of these races uses a pistol, the accuracy stats for the weapon are reduced by 30%.

The handgrip is different for the various races. The grip for an Eridani weapon (four fingers) is different from that of a Orion Rogue (seven fingers). If the grip is different, reduce accuracy statistics by 15. This rule applies to all discharge weapons, not just archaic powder.

## PISTOLS

**Smith and Wesson .22:** Not very powerful or accurate. It is, however, easily concealed. Best used for shooting Shukaren moon geese. Effective Range: 230m. Encumbrance: 2.

**Police .38 cal:** Widely distributed to the police forces in the latter part of the 20th Century. The .38 has a smooth profile with a swing out cylinder. It can be purchased with varying barrel lengths from 6-18cm. Each additional 3cm of barrel adds a 01% increase to attack rolls and costs 75 credits. Effective Range: 200m. Encumbrance: 2.

**Colt Python .357 Magnum:** A fantastic weapon in its day! The loud concussion response makes the .357 Magnum intimidating. It can be purchased with variable barrel lengths from 10-16cm. Each additional 3cm of barrel adds a +01% modifier to attack adjustments. Additional length costs 25cr per cm. Effective Range: 220m. Encumbrance: 2.

**Derringer .44 cal:** This small, one shot wonder was commonly called the Saturday Night Special in the 20th Century. The weapon is a mere 15cm in length and is a favorite of assassin types. The Derringer packs enough power to stop a Gen-Human. Effective Range: 145m. Encumbrance: 1.

**Smith and Wesson .44 Magnum:** The .44 Magnum revolver is vicious at point blank to medium range. The heavy recoil makes for lower accuracy statistics, and this weapon has a high concussion and blast rating. Speed loaders are available. Effective Range: 250m. Encumbrance: 3.

**Colt Anaconda .48 cal:** The most powerful semi-automatic handgun ever mass produced. A common terrorist weapon of the early 21st Century. Anyone with less than 60 strength must hold the Anaconda with 2 hands when firing it. It is often called the Terminator because of its very high one shot mortality rating. The Colt Anaconda has a high flash point and heavy recoil. The flash is quite visible at night. The barrel comes in varying lengths from 6-25cm. Effective Range: 340m. Encumbrance: 4.

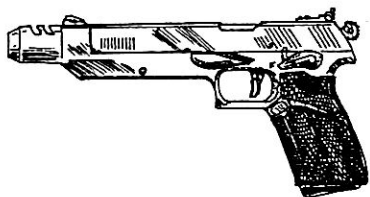

**Walther PPK:** First produced in 1929. The PPK was a favorite of espionage units in the 1930's. It is commonly recognized by its ivory stock. The Walther PPK uses .22 caliber rounds. Effective Range: 180m. Encumbrance: 2.

**Berretta 9mm Parabellum:** A double action, semi-automatic weapon. The Berretta was actively used in the U.S. military toward the end of the 20th Century. The high capacity magazine holds 15 rounds. The Berretta has low recoil with good damage yield. It is accurate out to a range of 300m. Encumbrance: 3.

**IMI Eagle:** This gas operated .44 caliber handgun was designed by the Israelis. The weapon is bulky compared to others in its class. It has excellent range out to 300m. Encumbrance: 4.

## RIFLES

**Galil Assault Rifle:** A product of Israeli brilliance. The Galil was first produced in the late 1960's. It uses NATO standard 7.62mm ammunition and is great for short range engagements. The system utilizes an integrated tripod which also functions as a pair of wire cutters. The Galil fires 12, 30, and 50 round clips. Effective Range: 150m. Encumbrance: 5.

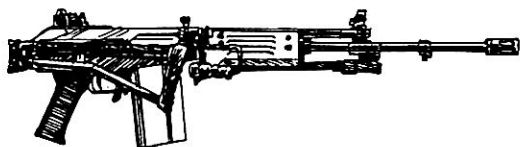

**AK-57 Automatic Rifle:** A light weight machine gun. The AK-57 was used predominantly by Soviet Bloc forces during the 20th and 21st Centuries. Its progenitor was the AK47. The AK-57 seldom jams. It has a good muzzle brake and uses a standard 30 round, 7.62 caliber magazine. Effective Range: 385m. Encumbrance: 6.

**Colt M-16A3 Rifle:** The original design was developed by Eugene Stoner in the late 1950's, with modifications made through the 1980's. Used extensively in the Mongolian Incursion. This weapon fires only 3 round bursts to conserve ammunition and was designed to engage targets within 300m range, but is fairly accurate out to 460m. Magazine Sizes: 20 or 30 round 5.56mm ammo. Encumbrance: 7.



**FN-FAL:** A fantastic design for its time. The FN-FAL is a long range, heavy impact weapon designed for sniper activities. It was used extensively in the Falkland War in 1982. The FN-FAL fires .308 cal. (7.62 mm) rounds. Effective Range: 1100m. Encumbrance: 10.

**TK-7A:** Invented by Talachiv Karashnichov in 2003. The TK-7A has almost no kick and the Valexxas-4 sharp sight is incredibly accurate up to 100m. A silencer can be purchased for 300cr. Effective Range: 1400m. Uses 7.62mm ammo. Encumbrance: 7.



**Barrett 82:** Another excellent sniper weapon of the late 20th and early 21st Centuries. The heavy recoil is reduced by an innovative muzzle brake. The Barrett comes with a bipod built into the forward section of the stock. It uses .50 caliber ammo for you types who are interested in overkill, and it can affect heavy armor normally. It is the optimum weapon to use on elephants. (Elephants have been extinct for 160 years; though, they have since been replaced by Ram Pythons). Effective Range: 1200m. Encumbrance: 12.

## SUBMACHINE GUNS

**IMI Uzi:** Designed for the Israeli army. The Uzi is a small weapon with a folding or removable stock. It is normally just over 60cm in length; this decreases to only 40cm without the stock attachment. The Uzi uses 9mm ammo and is fairly accurate at short ranges. It was mostly used by light infantry units and long range patrols. It is worth the investment. Effective Range: 240m. Encumbrance: 5.

**Thompson .45:** Affectionately called the Tommy gun. Designed in the early part of the 20th Century. The Thompson was first used by gangsters in the 1930's. Copies of this weapon are still available. It uses box or drum magazines. The box magazines come in 20 and 30 round sizes while the drums hold 50 or 100 shots. The Thompson is only accurate at short to medium range. It uses .45 caliber ammo, and it has a questionable malfunction rating. Effective Range: 100m. Encumbrance: 8.

**MP5:** A bolt-action submachine gun. It is very accurate in semi-automatic mode, but tends to overheat in full automatic (-04 to malfunction rating). The MP5 can be purchased with a permanent silencer attachment for 400cr above retail price. One can also purchase an impact version of the MP5 which adds +1 to damage rolls. This costs an additional 200cr. The short version has a pistol grip and is

## Hand Weapons

only 48cm long. This weapon is quieter than most when fired. It has an effective range of 750m and uses .45 caliber munitions. Encumbrance: 9.

## SHOTGUNS

**Ithaca Hammerless 10g:** Developed in Ithaca, N.Y. at the end of the 19th Century. The breach cracks open forward and down. This weapon is long, just over 85cm from stock to barrel. It uses a wide selection of shot. The barrel has been known to explode on occasion. Effective Range: 22m. Encumbrance: 10.

**Remington M870 12g:** The finest weapon of its kind, with the possible exception of the Masral 12g, pump action, double barrel shot gun. The magazine holds 2 rounds, with an extra in the chamber. Extended length magazines can be purchased; these hold 7 rounds. Certain modifications can be made to the 870, such as folding stocks, bayonet mounts, etc. The 870 is reasonably priced for a generic model. It is the additions that kill ya!!! Effective Range: 30m. Encumbrance: 10.

**Franchi SPAS 12g:** Purely a combat shotgun. The Franchi's features include a flexible stock, sling swivels, and a bayonet mount. It operates in auto (gas operated) or semi auto (pump) mode. The Franchi uses all types of 12g ammunition. Effective Range: 30m. Encumbrance: 8.

**Masral 12g Double Barrel Riot Control Shotgun:** Expensive, but worth every penny. It was extensively used during the Libya/USA Confrontation of 1995. The Masral Riot Control Shotgun is a pistol grip, pump action weapon. Both barrels can be fired simultaneously or one at a time by flipping a lever just above the trigger guard on the firing assembly. The Titanium steel suppressor spring reduces recoil. The Masral uses 5 and 10 round magazines. Effective Range: 30m. Encumbrance: 11.

**Pancor Jackhammer 12g:** An amazing weapon! One of the best automatic shotguns ever produced. It is fairly accurate and can pump out all 12 rounds in 4 seconds. It takes a full minute to completely reload. Effective Range: 60m. Encumbrance: 11.

## MACHINE GUNS

Belts of ammo can be linked together. The weight of 50 round belts are given below.

5.56:	3
7.62:	5

All machine guns can affect heavy armor, as they are considered vehicular weapons. Machine Guns require Archaic Powder Gunnery skill.

**M-60 Machine Gun:** Fires 7.62mm rounds. It was standard issue during the late 20th Century. There is nothing particularly special about this weapon. It was available in most countries on the planet Earth after 1955 and is often mounted on vehicles. The unit comes with tripod. Effective Range: 1100m. Encumbrance: 17.

**PK:** The Russian version of a light machine gun. Designed after World War 2 when the Russians began using standard 7.62mm rounds. The idea was that most infantry units engage targets at ranges less than 300m. The PK could engage targets beyond that range. This coaxial machine gun uses 100, 200, and 500 round belts. It was designed to fill a support role. Its malfunction number isn't the best. Effective Range: 1050m. Encumbrance: 12.

**XM-214:** This six barreled gatling gun is an elephant without enough to eat. The unit is powered by an external drive engine and comes with a body holster. It fires 5.56mm caseless rounds and isn't extremely accurate. The auto loading ammo box is attached to the base of the weapon. Effective Range: 700m. Encumbrance: 20.

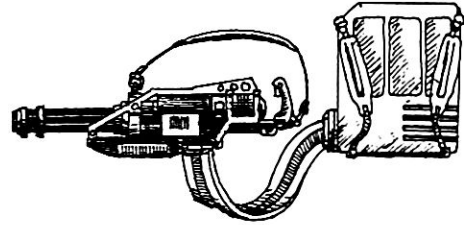

**LTX-311 Chain Gun:** Another unusual weapon that is powered by an external electric motor. This unit is exclusively mounted to vehicles or Ram Pythons. The 311 utilizes the independent action of a bolt feeder. This weapon is extremely unlikely to jam and fires 12 rounds in a single second. Effective Range: 1200m. Uses 5.56mm ammo. Encumbrance: 26.

## BEAM WEAPONS

Lasers are long range weapons that do considerably less damage than pulse or Omega weapons. Beam weapons affect armored vehicles as well as building structures. They are powered by energy packs which contain a specific number of charges. It cost 5cr to recharge each shot. Lasers are efficient against body armor. The beam is not affected by the absorption polymers, unless special ablative liners are purchased. Once a laser beam penetrates the threshold of an armor suit, it does straight body damage. Laser beams don't diffuse much over distance, but are limited in their sighting capabilities. Due to the shake matrix of the weapons and the limitations of automatic, computerized, telescopic sighting, the stated ranges can not be modified. The most efficient scopes have already been employed. Player characters can purchase scope modifications such as infrared sighting to "beef up" their weapon. The major drawback of lasers is that concentrated smoke diffracts the beam and reduces damage yield significantly.

## LASER PISTOLS

**Mirchaum SSLU:** This unit is a 1 shot laser, consisting of a small energy cell and the laser itself. It fits in the palm of the hand of the average Gen-Human. The powerful refractive system refines the beam. The Mirchaum SSLU is easily concealed and is sometimes used by assassin types. Effective Range: 85m. Encumbrance: 1.

**OLC-Laser Pistol:** This artifact was first tested in 2025. Experimental lasers before this had been overly expensive to produce. The OLC was the first functional weapon of its type. It would take roughly 6 shots to kill a Python Lizard. (By that time he has reduced you to component atoms). Effective Range: 140m. Encumbrance: 3.

**Penasonic-PL3:** First fielded in 2032, it was the primary weapon used by officers in the U.S. Army. Not a bad pistol. The high malfunction and shock numbers make it functional under heavy combat situations. The Penasonic doesn't do enough damage. Effective Range: 175m. Encumbrance: 3.

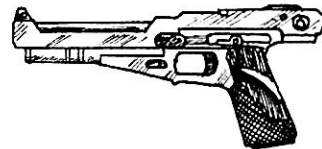

**BS-2 Laser Pistol:** Developed by the Balshrom Science Corporation. Still widely used on the New Colonies and Tech Level 4 planets or lower. The BS-2 is the standard weapon in most Rebel arsenals. The fast recycle time produces 2 shots per fire segment. It has reasonable malfunction and system shock numbers. Effective Range: 135m. Encumbrance: 3.

**MC-6 Laser Pistol:** An experimental model designed to penetrate heavy body armor. The electronic circuitry attempts to boost beam output frequency. This weapon has exploded in the hands of the test operator more than once. In the event of a malfunction, re-roll percentile dice. A result of 96 or higher indicates that the weapon has exploded and its owner takes 4-16 points of fragmentation and fire damage plus an additional 2-12 concussion damage. Questionable at the very best! Effective Range: 600m. Encumbrance: 4.

**Savage-B:** The state of the art in optics technology. The Savage-B has incredible recycle time, firing 3 shots per fire segment. The Rexon energy clip has 15 charges and there is virtually no chance of system malfunction. The Savage-B is compatible with the Rexon 4 energy pack for continuous fire situations (50 shots, 1500cr). It is extremely accurate and has a good damage yield. It is the preferred pistol of the Galactic Marines. Effective Range: 550m. Encumbrance: 4.

## LASER RIFLES AND CARBINES

**M16-L Laser Rifle:** Affectionately named after the powder rifle that was used by American troops in the 20th Century. The M16-L is a low frequency laser that fires a beam in the red spectrum of light. Effective Range: 700m. Encumbrance: 8.

**M18-L Laser Assault Rifle:** A much improved version of the M16-L. The St-3 Flex Foam cartridge protects the parabolic mirrors from shock damage. Beam attenuation is minimal. Effective Range: 900m. Encumbrance: 8.

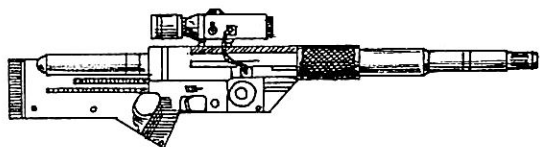

**RKM Laser Assault Carbine:** Developed after the 1st Arachnid Incursion to penetrate Arachnid heavy armor. The RKM mounts an M-L50 pump action grenade launcher. It has an integral tripod built into the forward section of the stock. The RKM uses 2 different energy packs, 100 and 200 shot. This weapon is virtually shock proof and it is comparatively light for most assault carbines. Range: 850m. Encumbrance: 9.

**Backshaw Light Laser:** Used by light infantry units. This carbine is designed for operations in low combat risk areas. Unlike its relatives, the Backshaw doesn't use an energy pack. It uses a clip. It is a good weapon for those individuals who don't intend to remain in a HOT environment for extended periods of time. Effective Range: 765m. Encumbrance: 10.

**Toshoni LL-C:** This light laser trades heavy damage yield for a 2 shot per fire segment output system. Like the Backshaw, it is light, using an energy clip instead of an energy pack. The clip holds enough energy for 40 shots. Effective Range: 650m. Encumbrance: 12.

**Tagert-6 Shock Gun:** The first high powered laser carbine. It has a fast recycle time. There are three major drawbacks: weight, size, and the malfunction number. Effective Range: 800m. Encumbrance: 11.

**Micron Carbine:** It has excellent range, great damage yield, and good accuracy statistics. The fast recycle time provides for ripple fire bursts on automatic. Effective Range: 1050m. Encumbrance: 8.

**Arrow LOSN:** This sniper rifle is used by the majority of would-be assassins. It's light and portable, yet retains formidable fire power. The Arrow LOSN comes with a tripod, and the beam output frequency is in the ultra-violet range of the spectrum. Effective Range: 1280m. Encumbrance: 11.

**Shalkon Carbine:** The only solar powered laser on the market. It needs no energy pack. The solar ducts absorb incoming solar radiation and the Shalkon is capable of storing enough energy for 25 shots. The ducts can store four shots an hour on sunny days, two an hour with partial overcast, and one an hour with heavy overcast. The system shock number is low (94), so don't drop it! Effective Range: 245m. Encumbrance: 10.

**Alpha 2:** The first in a series of output adjustable lasers. The Alpha 2 was designed by the Balshrom Science Corporation. The output transducer adjusts for increased power. The variable settings do 2-12 and 1-8 points of damage respectively. The high output setting uses up 2 charges. Effective Range: 1230m. Encumbrance: 12.

**Beta 3:** The Beta has been on the market for just over 10 years. It is another output adjustable laser and is a favorite of many light infantry types. Damage output is the same as the Alpha 2 but the rate of fire is doubled. Effective Range: 1230m. Encumbrance: 15.

**Falcon XR-7:** This is an attempt at creating a high speed multi-beam machine gun laser with the body configuration of a rifle. The experimental multiple phase coupler generates up to 3 beams per fire segment. The Falcon uses an energy clip. The system has been marketed by Marrson Optics Corporation. Take your chances. Effective Range: 1300m. Encumbrance: 20.

**Gamma 4:** Balshrom Science Corporation's latest futuristic laser carbine. The Gamma 4 is a light weight, heavy combat laser. It has three different output settings, and can fire four pulses in a single melee segment. The variable settings do 1-8, 2-12, and 3-18 points of damage. They use up energy at the rate of 1, 2, and 4 charges respectively. A heavy energy pack, which holds 500 charges, can be purchased for 10,000cr, and adds 3 to encumbrance. The weapon shops can't keep this weapon on the shelf! Range: 1230m. Encumbrance: 15.



**Calsham 4:** Uses a phase altering integrated enhancement system. The beam attenuation problem has been eliminated. The Calsham 4 is capable of engaging targets at a range of 1500m and does some serious damage! Encumbrance: 14.

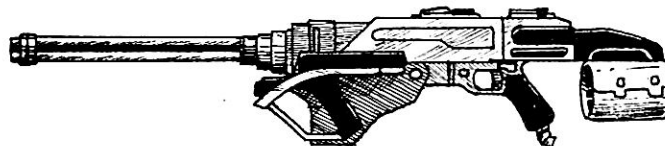

## IMPACT LASERS

Impact Lasers do full damage to heavy armor.

**Lancer:** Designed by the Balshrom Science Corporation, this is the first in a series of Impact lasers. The Lancer allows the combat soldier to effectively engage heavy armor at long range. Check the price before you consider picking up one of these units. Effective Range: 2700m. Encumbrance: 12.

**Crusader:** Marrson Optics is proud to present this new Impact laser. Like all Impact lasers, the Crusader doesn't have its damage yield reduced when it is employed against heavy armor. Effective Range: 2600m. Encumbrance: 12.

**Excellior:** Marrson Optics can boast about having produced this weapon, much to the chagrin of the Balshrom Science Corporation. Effective Range: 3450m. Encumbrance: 16.

## MACHINE GUN LASERS

These weapons require Beam Gunnery skill.

**Valley Green Assault Gun:** The Valley Green Assault Gun is the "Bread and Butter" of ground assault squads on Stormtrooper battlecruisers. It is lugged into the combat zone where it is assembled (7-12 minutes). Effective Range: 2350m. Encumbrance: 65.

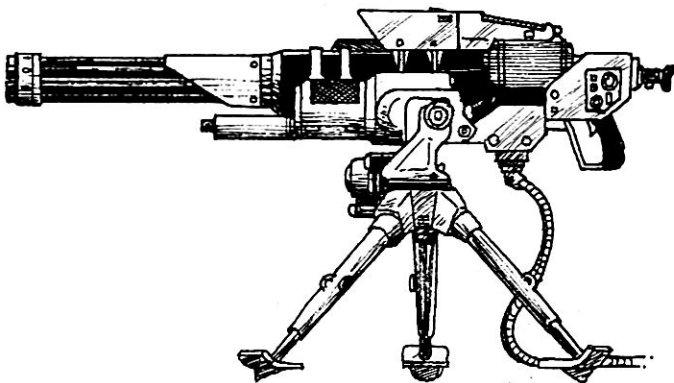

**Shalkon Heavy:** Is an experimental heavy laser produced by the Shalkon Corporation. It is found only as a demonstration model at LZ conventions. Prospective buyers consult Shalkon Corporation for information. (Telephone Code: 261-4597-444-718-836-6213). Effective Range: 2600m. Encumbrance: 55.

## PULSE WEAPONS

Pulse weapons are short range, high shock value instruments, primarily used by Assault Groups of the GDF. They fire accelerated plasma pulses and utilize a fusion reactor which generates the power necessary to facilitate weapons discharge. The plasma pulse is surrounded by a magnetic bottle to keep the energy from dissipating. Pulse weapons are heavier than lasers and are much more expensive. They do, however, reduce things to rubble at close range. Pulse weapons are the preferred weapon of the Python races. Body armor penetration reduces armor integrity by 8 points. All pulse weapons are rechargeable at a standard cost of 20cr per shot. Pulse weapons don't incur a penalty to hit when firing at concealed targets, although the damage is halved.

**PC-3 Pulse Rifle:** With the advent of pulse technology, scientists experimented with the use of energy plasma as a weapon. The first problem was to isolate the plasma in a magnetic flux force field. This was eventually accomplished with the invention of the T-chamber. Another problem was that the weapons systems were too heavy to be operated by one individual. Robert Thisalis developed the first inertial-grav system for practical use. The PC-3 is considered to have been the first functional pulse rifle, although there is some dispute. The Balshrom Science Corporation claims to have developed the first pulse cannon, but it's claim has never been substantiated. The PC does a formidable 3-18 points of damage. The energy pack is somewhat unstable, and a roll of 90 or above, subsequent to unit malfunction, indicates that the weapon has exploded and the victim takes 3-18 points of body damage. Effective Range: 25m. Encumbrance: 17.



**PC-6 Pulse Rifle:** An improved version of the PC-3. The problem of pack explosion has been resolved. Effective Range: 45m. Encumbrance: 22.

**M-20 Blaster Cannon:** An excellent cannon! It trades a little range for a lot more damage. The M-20 has a good inertial-grav system and comes with a built-in tripod in the stock. Effective Range: 130m. Encumbrance: 20.

**Mentar Reflex Rifle:** The first multiple shot pulse rifle. The advanced recoil suppression system uses St-3 Flex foam. The Mentar packs sufficient firepower, but is only accurate out to a range of 115m. Encumbrance: 18.

**RP-4 Masher Cannon:** It is devastating at point blank range. You can "fry" a Python Lizard in a single fire segment. The energy pack is bulky and sensitive to electrical shock (reduces the system shock number by 20). The owner can increase the output power by flipping a lever on the side of the trigger guard assembly. This doubles damage yield (10-60). Ten charges are used up when the plasma pulse is "juiced up". Effective Range: 115m. Encumbrance: 22.

**Vector 1:** The Vector Corporation claims to be the only company to produce a plasma pulse system with an effective range beyond 350m. Not anymore. The pulse is less powerful than most, due to different "bottle" technology employed. The Vector 1's shock value is heavy enough for assassination attempts. Effective Range: 700m. Encumbrance: 13.

**BC-Engager:** Besides lasers, the Balshrom Science Corporation has produced a variable energy discharge pulse rifle. The damage meted out by the Engager is 2-12 points of damage on low power and 3-18 points on high power. The low power pulse uses up one charge while the high pulse uses up two charges. Effective Range: 150m. Encumbrance: 18.

**Vector 3:** Multiple improvements were made on the Vector 1. The Vector 3 has better malfunction and system shock numbers. Effective Range: 750m. Encumbrance: 13.

**BC-Enforcer:** Standard issue to police units. The BC Enforcer is a powerful, variable discharge pulse cannon. The different types of pulse drain one charge or two charges, doing 3-18 or 4-24 points of damage respectively. The Enforcer fires twice every fire segment. Effective Range: 180m. Encumbrance: 16.

**Vector 4 "Power Vector":** What difference does it make if the enemy has a Terminator, when you can pick'em off long before he gets to range? The Vector 4 can engage targets at 800m and still do a reasonable amount of damage. Encumbrance: 17.



**Mentar-A3L Assault Cannon:** One of the most powerful pulse weapons available. Ensures messy kills for you sick types. No major system drawbacks, except weight, and a tendency to overheat. The energy pack is relatively small, considering the amount of charges that it holds. Effective Range: 240m. Encumbrance: 20.

**BC-Destroyer:** Appropriately named. This system is wicked! It fires up to three times per second and the two output power settings generate 4-24 and 5-30 point pulses. The Destroyer is good for vaporizing targets who are stupid enough to get close to you! Effective Range: 170m. Encumbrance: 18.

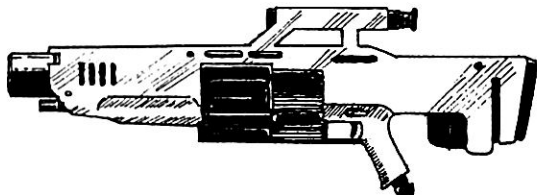

**BC-Terminator:** Incredibly expensive, yet worth it! The Terminator has three discharge settings, light, heavy and super heavy (squish), that allow you to do 4-24, 5-30, and 6-36 point of damage to your opponents. These settings use up 1, 2, and 4 shots respectively. Effective Range: 185m. Encumbrance: 20.

**M-80 Defender Cannon:** The technology developed for the Vector 4 was stolen by the Ramcor Corporation and used to build this weapon. Virtually the same, except the recycle time is much faster (technology that Vector was unable to obtain.) The M-80 Defender fires 4 pulses per fire segment. Effective Range: 550m. Encumbrance: 20.

## THE OMEGA PRINCIPLE

The Omega class weapons represent the ultimate in futuristic weapons technology. The Omega Principle was first theorized by Professor Alexandratos of the Tashinir Research Institute in 2189. It was long known that electrons move randomly about an atom. The Schrodinger equation allowed for one to predict the locus of probability, instead of the exact location of the electron around an atom at any given instant. If the electron's position could be manipulated, then a powerful force field could be created by bringing an enormous number of electrons together at any specific point at any given instant. With the help of the Mutzachan scientist Trashim, Alexandratos discovered how to manipulate the internuclear forces between atoms. He called it the Omega Principle. The present day flux shield and all Omega weapons are a result of this breakthrough.

Since the Omega principle predicts the creation of an instantaneous barrier by manipulating huge amounts of negatively charged electrons together at one moment, scientists soon began experimenting with the possibilities of using the Omega Principle in weapons technology. The idea was to create a force field, fire it from a cannon, and then control the energy dissipation matrix through the use of a magnetic flux bottle. A powerful flux barrier could thus be fired at personnel or armor. The result: A deadly weapon called the "Thud Gun." The Thud gun does massive concussion damage. It does not affect armor integrity as the concussion pulse is translated straight through to the absorption layer in the form of a powerful shock wave. The pulse also disrupts exposed electronic circuitry, much like an EMP pulse (weak effect; +20 to body armor and weapon SMR). Thud Guns are capable of knocking out flux shields, doing damage on a point for point basis. A hit from a Thud Gun on any normal inertial-grav system has a 05% chance of destroying the sensitive inertial grav generator and thus rendering the inertial gravity system useless.

Omega weapons are heavy, even with their built in inertial-grav systems. There are some inherent problems in the power coupling circuitry. Omega weapons are only marginally accurate, due to the heavy counter pulse that is generated when the weapon is fired. Recharge Cost: 30cr per shot.

## OMEGA CANNONS

**OC-1:** The first mass produced flux cannon. Designed by the Able Corporation in conjunction with the Tashinir Institute. The OC-1 is inaccurate and unreliable. Still, it can wipe out a Python. (Why does everyone want to kill Pythons anyway?) Effective Range: 50m. Encumbrance: 15.

**Balshrom Flux Cannon:** A fair system overall. The targeting system has been improved and many of the other inherent problems have been worked out. The Balshrom Flux Cannon is affordable. Effective Range: 50m. Encumbrance: 16.

**Valley Green OX:** High Tech Weapons Manufacturing, a subsidiary of the Able Corporation, first produced this flux cannon in 2207. The OX has good all around stats and the system is compatible with the M-L50 grenade launcher. Effective Range: 110m. Encumbrance: 20.

**Able 3:** Another product of the Able Corporation. It has an outstanding inertial-grav system. The user gains -1 to initiative rolls. The Able 3 is fairly accurate at point blank and short ranges. Effective Range: 110m. Encumbrance: 17.

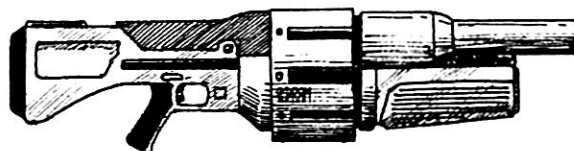

**LS-21:** A real Thud Gun for you hardcore maniacs who like the sight of blood!!! It mounts directly to the individual via a body harness. The harness straps over the shoulders and around the waist and firing arm. The unit is thought activated, lending the wielder a -2 to initiative rolls. The low malfunction number raises some doubts as to the overall value of this unit. I wouldn't buy it, so you probably shouldn't. Effective Range: 120m. Encumbrance: 14.

**Able Ram:** The first rapid pulse flux cannon. It has a terrible malfunction number, and is considered to be a promotion gag more than anything else. It does good damage when it works. Think twice before buying this unit. Effective Range: 130m. Encumbrance: 18.

**Viper XM1:** Compliments of the Ramcor Corporation. Not too expensive, no thrills, and it works. The only "functional" two shot flux cannon. Effective Range: 175m. Encumbrance: 20.

**Balshrom 2:** Produced in response to the Cobra. The Balshrom 2 is a body mount Omega cannon. It doesn't have a thought activated fire system, but is accurate out to 120m range. It has a faster rate of fire than the Cobra and is somewhat cheaper. Encumbrance: 22.

**Cobra XM2:** Shortly after producing the XM1, Ramcor produced a three shot flux cannon, unprecedented for the times. This baby can dish out almost 100 points of damage in a single fire segment! The Cobra uses a body mount configuration and has a thought activated fire system: -2 on initiative rolls. Range: 200m. Encumbrance: 20.

**Python XM3:** The top of the line from Ramcor. A million credits is a lot to spend on a weapon, but you can take out almost anything with a Python XM3. This system can actually penetrate tank armor and has a thought activated firing sequence like all Ramcor flux cannons. Ramcor stole the inertial-grav technology from Able Corporation to make this model manageable. How thoughtful! Effective Range: 90m. Encumbrance: 25.

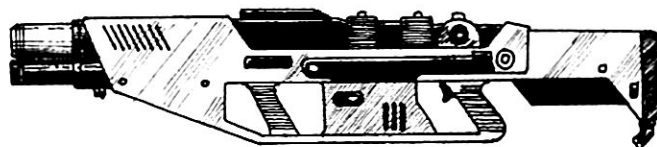

**Devastator: *The Supreme Thud Gun!!!*** The optimum in Omega technology. The Devastator utilizes micro feed implant technology (i.e. It is plugged straight into the brain. Problem: individuals using micro-feed weapons who are hit by electromagnetic pulses take 1-3 points of damage, suffer automatic brain hemorrhaging, lose 1 point of blood per minute, and there is a 50% chance of a permanent loss of 2-12 points of I.Q. The moral of this story: get EMP shielding!) The cost of implant surgery is included in the list price. The individual merely thinks fire and the weapon discharges: He gains a -4 to initiative rolls. The Devastator comes with the most advanced inertial-grav system available and uses a body mount weapon harness. This jewel is handcrafted to order. Only 2000 units exist. Effective Range: 125m. Encumbrance: 22.

## PARTICLE WEAPONS

Particle technology is new and still experimental. Scientists have managed to isolate anti-matter and use it as a weapon. A low frequency laser is first fired, ionizing the air. The AM particle is then accelerated and fired, encased in a magnetic envelope. The magnetic envelope is controlled so that the path of the particle can be bent. AM particles can actually fire around corners or over objects. The major problem is the sighting mechanism for such weapons. Most use mobile camera systems. Due to the speed of the particle, armor threshold is reduced by 2 points when determining threshold attenuation. AM particles are not affected by absorption polymers. All damage that passes threshold does straight body damage. Magnetic disruption negates the effects of this weapon.

**AM1:** The first experimental particle weapon. Designed by Helix Unlimited. The AM1 is inaccurate and has an effective range of only 50m. Encumbrance: 5.

**Cheetah:** Balshrom Science Corporation is the only company currently producing particle weapons, although the AKM corporation is trying to enter the market. The Cheetah is the first of Balshrom Corporation's CAT series particle weapons. Effective Range: 115m. Encumbrance: 8.

**Tiger:** The better range and all-around performance of this weapon makes owning it enticing. One can engage targets out to a range of 210m. Encumbrance: 10.

**Mark 3:** Still being tested. AKM's answer to Balshrom's monopoly over the particle beam market. All specifications beat out any CAT, except the Lion. Prototypes are available. Effective Range: 725m. Encumbrance: 10.

**Lion:** Does a lot of damage and has excellent range. It is the largest of all the CAT series. Effective Range: 500m. Encumbrance: 16.

## METAL GUNS

Metal guns fire a magnetic disruption pulse that wreaks havoc on metallic objects. These weapons represent the latest in body armor engagement systems. Metal guns do no damage to non-metallic objects. They do, however, permanently reduce the threshold of body armor. They are valuable instruments of combat and should not be overlooked when characters purchase weaponry. Recharge Cost: 30cr per shot.

**BC-Render:** Balshrom Science Corporation can't seem to get enough of the weapons market. The Render is all but worthless though. Effective Range: 95m. Encumbrance: 10.

**BC-Shredder:** The Shredder is useful against low level armors. Effective Range: 90m. Encumbrance: 9.

**TR-9B:** Designed to take out medium level body armor. This system is perfect for the job, but you've got to pay for it. Effective Range: 200m. Encumbrance: 10.

**Parabellum:** This weapon is powerful enough to dust most heavy armors in two shots. It is quite expensive, but the Galactic National Weapons Association (GNWA) gives it high marks. Effective Range: 160m. Encumbrance: 10.

**Calsham MG:** The Calsham metal gun is the most expensive weapon of its kind on the market. It was originally designed to take out MBA in one shot. Practical applications suggest that it is better used against buildings or tanks! Effective Range: 220m. Encumbrance: 13.

## MAG GUNS

Mag Guns are long range logistics weapons with a variety of uses, developed in 2127 by Avars Manshan, the great Chatilian braintrust. The concept behind the mag gun is that because heavy armors are generally only susceptible to Omega, PMS, and pulse systems, a magnetic round could more easily penetrate heavy armor from longer distances at less expense. Mag guns fire a magnetic adhesive round that sticks to metallic objects such as body armor when it comes into contact. The magnetic attraction is so strong that the round can not be pulled off by normal means (strength check at a minus 110). The conventional way to remove a mag round is to dissolve it with acid or de-magnetize it. Acid destroys 1-8 points of armor integrity and can be a problem if you're a cyborg with a round sticking to your forehead! Mutzachans also can remove a mag rounds by employing a magnetize matrix.

All mag guns are equipped with a sonic suppression system that reduces the recoil and lowers weapon report. Below are listed those mag guns currently in production along with the available munitions.

**Stick Gun:** The first Magnetic Gun, produced in 2197 by the Able Corporation. This system has limited range and suffers from severe malfunction problems. It can sometimes be picked up for 75% of the list price. Effective Range: 140m. Encumbrance: 8.

**Deliverance:** The weapon system is in high demand. It has excellent range and unparalleled reliability for those in its class. It comes with a built-in radar tracking system and an ECCM computer rated at 30%. The Deliverance is a product of the Balshrom Science Corporation. It costs a lot. Effective Range: 600m. Encumbrance: 8.

**Marrson Metal Man:** Marketed shortly after the release of the Stick Gun. The Metal Gun has good range, but a questionable system shock number. It is also quite heavy when compared to others in its class. Effective Range: 1000m. Encumbrance: 12.

**Magnatron:** Most weapon consumers consider this to be the most cost effective of all the mag guns. It has above average stats in all areas, and comes with a built-in radar tracking system to assist the owner in locating viable targets. Effective Range: 1200. Encumbrance: 10.

**Carousel:** A product of the Able Corporation, this is the only rapid discharge Mag Gun available. It comes with a built-in radar system (priority ranging), and an ECCM computer rated at 40%. Effective Range: 450m. Encumbrance: 15.

## MAG GUN MUNITIONS

**Absorption Destroyer:** The round carries a laser that is activated when the charge strikes the target. The round then secretes Dioxo-triphosphate which dissolves absorption polymers in body armor. 3-24 points of polymers are destroyed.

**Acid:** The acid round secretes hydrogen bromide upon contact. Armor integrity is permanently reduced by 2-12 points. Corrosive protection negates the effects of this attack.

**Audio/Visual Broadcast:** A camera/transmitter relays a visual picture with sound components back to the launcher. The cost includes the monitor. Effective Range: 700m.



**Biological:** The round carries a small laser that activates when the charge strikes the target. The laser burns a hole in the armor, then injects toxic bacteria. Individuals must make a successful SMR or suffer 4-24 points of damage. There is a 90% chance of permanent damage to those persons who fail their SMRs. They lose 4-24 points of strength and constitution permanently.

**Chemical:** Utilizes the same activation system as the biological round. However, it injects Nerve Agent-5. Victims must make an SMR or suffer 4-24 points of damage. There is a 70% chance of permanent damage for those persons who fail their SMRs. They lose 2-20 points of agility, manual dexterity and I.Q.

**Dummy Round:** Carries no warhead. It is merely a magnetic charge that adheres to metallic surfaces and scares the bejeezus out of whoever it sticks to.

**EMP:** The most expensive of all the Mag rounds. This device emits a powerful electromagnetic counter pulse that knocks out all electronic equipment within a 5m area. The electronic equipment has an SMR of 20-80, depending on the tech level and insulation.

**Floric Acid:** The floric acid round emits a cloud of gas which melts through glass in seconds. This is great to use against the flex-glass in body armors. Most helmets have an SMR of 35 against this attack.

**Infrared Strobe:** Emits an infrared strobe that wipes out thermal imagery or infravision sighting systems within a 20m radius. This round is particularly dangerous to Python, Eridani, and Mazian characters who must make a successful SMR vs Radiation or be blinded for 2-8 hours. There is a 10% chance of being partially blinded (2-20 points subtracted from the vision modifier). There is a 2% chance of permanent blinding.

**Planar Explosive:** These charges explode along a plane which is perpendicular to that of the gravitational force. The round does 5-30 points of damage to all targets within a 20m radius along the plane of contact. Any appendage that suffers catastrophic damage as a result of the explosion is considered to be severed from the body.

**Position Broadcast:** Broadcasts a homing beacon to a monitoring device out to a range of 4000km.

**Radar Enhancement:** Acts as a doppler enhancement unit, increasing the chance of radar lock by 25%.

**Rubber:** This round secretes a rubber dissolving vapor that destroys all rubber substances within a 10m radius. Potential targets are entitled to an SMR of 20-40.

**Shaped Charge:** Explodes inward from the point of contact and does 3-18 points of damage. Armor threshold is reduced by 5 points when determining penetration damage.

**Smoke Generator:** This round gives off a thick colored smoke for 5 minutes, subsequent to target contact.

**Sounder:** Emits a high pitched pulse which can be heard for up to 500m.

**Super Sonic Pulse:** The pulse emitted automatically knocks unconscious any individual who fails his SMR vs sonics. Mazian, Cizeracks, and Chatilians have a -20 penalty to their dice rolls.

**UV Strobe:** Generates a powerful ultraviolet strobe that knocks out UV sensitive objects within a 20m radius. Cizeracks must make an SMR vs sonic or be blinded for 2-8 hours. The chance for permanent blinding is the same as with the Infrared Strobe.

## THE NUCLEAR EFFECT

The Nuclear Effect was first discovered in 2190 by Professor Christopher Rutledge, a renowned physicist of the Poly Technot School. By 2212, weapons scientists had begun experimenting with the phenomenon now known as the "Nuclear Effect." NEWs create powerful electric fields that draw electrons away from the atoms. The resulting bare nuclei are all positively charged and repel each other, effectively disintegrating. NEWs are classified by their proton scatter matrix. The damage is designated as tissue/metal. This is a result of the conductive properties associated with metals. The mobility of electrons in a metallic conductor allows the charge to be equalized and prevent total disintegration. However, while this effect prevents disintegration, it creates a strong positive charge in the metal. This charge will deliver electrical damage equal to the initial damage done upon contact to "ground." Thus if a Duster does 30 points of damage to a suit of D2 armor, when the person in the armor touches a metallic object or grounds himself he will deliver 30 points of shock to whatever he touches. A person wearing armor is considered insulated from the shock for as long as his absorption polymers remain intact in all sections of his armor. The cost to recharge a NEW is 10cr per shot. There are two classes of NEWs, Disruptors and Disintegrators.

## DISRUPTORS

**Neutralizer:** The first Neutron Effect Weapon. The Neutralizer ruptures the intramolecular bonds in objects. It does 4-24 points of damage to skin tissue and 1-8 points of damage to armor integrity or other resistant objects. The weapon is heavy and has an appalling system shock number. Effective Range 20m. Encumbrance: 4.

**K-4 Proton Cannon:** Produced and marketed by Haber Electronics. The unit has fair range and reasonable damage yield. Effective Range: 45m. Encumbrance: 9.

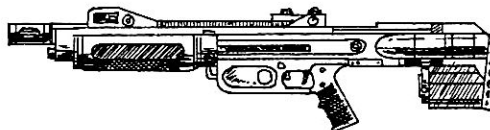

**Majestic:** Who else but the Balshrom Science Corporation? This company is the king of the weapons manufacturing industry. Like most Balshrom products, the Majestic has better than average stats and costs less than many of the others in its class. Effective Range: 40m. Encumbrance: 7.

**Majestic 2:** An improvement over the Majestic. Effective Range: 40m. Encumbrance: 8.



## DISINTEGRATORS

**Balshrom Duster:** It can vaporize a Python in a single fire segment. Not bad, but the malfunction number is a little low. It does 20-80 points of damage to tissue and 1/2 that amount to metallic objects. Effective Range: 40m. Encumbrance: 8.

**Gashil:** Designed by the Israelis Commune government. It is vicious at close range. Effective Range: 40m. Encumbrance: 9.

**The Americas:** Designed by the Hansen Electronics firm of New Buffalo, New York. It has excellent range and good damage yield. Effective Range: 80m. Encumbrance: 10.

**NE-7 Comrade:** Another Hansen Electronics product. Unlike the Americas, this disintegrator is designed for close quarters combat. Effective Range: 35m. Encumbrance: 14.



**Rommel:** Designed by Max Reinhart. Whatever the Rommel hits is in "deep yogurt." The Rommel fires twice in a fire segment. Effective Range, 40m. Encumbrance: 14.

## MESON CANNONS

Meson cannons only affect force fields. They reduce energy fields on a point for point basis. These weapons are body mounted and are effective at short to medium range. They have high malfunction and system shock numbers. Recharge Cost: 20cr per shot.

**Accelerator:** A product of Hansen Electronics. Effective Range: 30m. Encumbrance: 4.

**Henderson:** Developed by the renowned physicist, Michael Henderson. The Henderson has good all around stats and is reasonably priced. The cannon fires twice per discharge segment. Effective Range: 85m. Encumbrance: 4.

**Emissions:** AKM's version of a force field disruption device. This weapon is fairly cheap and has a 25 shot energy clip. Effective Range: 85m. Encumbrance: 4.

**Pulsar:** The most potent meson cannon for the money. It has excellent range and good damage yield. It is, however, quite heavy. The Pulsar comes with a tripod built into the forward section of the stock. Effective Range: 600m. Encumbrance: 25.

**Quasar:** This weapon has an unbelievable range of 1500m. The Quasar is a vehicle mounted weapon used to engage armor at long range. Encumbrance: 110.

## FLAMETHROWERS

Flamethrowers are devices designed to spray highly flammable liquids at targets. Their primary purpose was to engage and destroy hardened enemy positions such as bunkers and pillboxes during the 20th Century. The blast of a flamethrower covers a conical area which is 05m wide at the mouth. The inherent problem with a flamethrower is its vulnerability to tank puncture. Compromised tanks have a base 20% chance to explode. Flamethrowers have since been abandoned in favor of more stable weapons.

All damage done by flamethrowers against full body armor is halved and translated directly to the absorption polymers which break down under the intense heat. Armor integrity is not affected unless the

armor fails its SMR vs fire. Failure indicates melting: loose 2-12 integrity and owner is at -(2-12) on agility due to damage to the armor's joints. Flamethrowers affect 3 areas of the body with each hit.

**A-2:** Is a light weight, 5 shot, disposable flamethrower. It can fire continuously for up to 5 seconds. Encumbrance: 6.

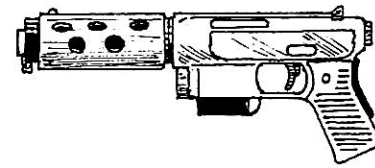

**ME2E1-9:** A common weapon of Soviet arsenals during the 1990's. The ME2E1-9 is body mounted and fires variable discharge bursts which do 1-6, 2-8, and 3-12 points of fire damage. Each burst uses up 1 shot, 3 shots, and 5 shots respectively. This flamethrower can fire continuously for up to 10 seconds. Encumbrance: 20.

**ME2E1-9B:** This system incorporates a different nozzle configuration to increase the spread of the stream (+2m spread). The improvement is controversial because the overall malfunction number is decreased. Encumbrance: 20.

**The Blazer:** The last widely produced flamethrower. It has excellent range, compared to others of its like. The Blazer can fire continuously for up to 15 seconds. Encumbrance: 10.

## ROCKET LAUNCHERS

These weapons serve a different purpose than grenade launchers. Rocket launchers are flat trajectory weapons that can put a round in a small area at long distances. They pack high explosives, but do little fragmentation damage. Any individual who happens to be standing within 1 meter of the explosion, is struck by 1-6 fragments. The number of fragments that strike personnel is reduced by one for every meter that the target is from the point of impact. The concussion damage for rocket launchers is 100% out to 02m, 50% from 3-4m, and 25% from 05-06m. Beyond 6m, concussion damage is temporary stun damage (rated at 50% of total damage.) Rocket launchers are not designed to fire at personnel and suffer a -20 to attack rolls when employed in this manner. To determine the time it takes to aim at any given range bracket, multiply the number of the bracket by two.

**Example:** Fred has the perfect attack planned. Two Cizeracks are sitting by a window inside a building some 150m away. Fred has a Belair rocket system and 150m is considered to be range bracket 5 for attack purposes. Aiming Time:  $5 \times 2 = 10$  seconds.

**Belair RL:** It is intended to provide a big punch for light infantry units. It is extremely accurate, but lacks the concussion yield needed to knock out fortified positions. Encumbrance: 9. Missile Cost: 250cr.

**Steiger 3:** Produced by the German Republic in 2090. The Steiger is a long range rocket launcher. Each missile costs 500cr. Why so much? The Steiger's extra range makes for quite a formidable weapon. Encumbrance: 10.

**Zandovich:** Another excellent Russian design. The Zandovich is a multi-fire rocket launcher, capable of launching up to four missiles simultaneously. Encumbrance: 10. Each missile costs 300cr.

## ANTI-TANK WEAPONS

At some time or another, most combat troops must engage enemy armor. This is not a moment that is relished by many, for if you fail to engage and destroy the enemy armor then your demise will inevitably follow. The type of anti-tank weapon that PCs should purchase

depends entirely on the Tech level of the enemy armor. The aiming time is the same as with rocket launchers.

**Panzerfaust:** A staple item of the Wermarcht during the Second World War. The Panzerfaust is actually quite potent and can still knock out a Tech level 3 light tank. The problem is its range of only 40m. Missiles cost 150cr. Encumbrance: 14/5.

**Bazooka:** This archaic piece of junk couldn't even put a dent in a modern tank! It just doesn't have the "stuff". It is useful against Tech level 2 tanks. Additional missiles cost 500cr each. Effective range: 200m. Encumbrance: 15/5.

**LAW:** Used in the Vietnam Conflict by American forces. The LAW is a single shot, disposable launcher, designed to engage light armor units such as APCs and trucks. It is fairly accurate up to 1000m. Encumbrance: 7.

**RPG7-B:** An improvement over the RPG-7. The primary weapon used by Soviet Bloc troops during the Mongolian Incursion of 1999. The RPG7-B has better range and accuracy compared to its progenitor the RPG-7. This weapon is formidable and reusable. Additional missiles cost 400cr each. Encumbrance: 10/3.

**Dragon:** The Dragon was produced as a means to address the problem of medium sized Soviet Bloc tanks. The system is wire guided and has limited range. Missiles cost 3000cr. Encumbrance: 60/15.

**TOW:** The acronym stands for Tube launched, Optical tracked, Wire guided. The TOW anti-tank weapon was first deployed in the late 1960's by the U.S. Army. It served its purpose and still does. Missiles cost 5000cr apiece. Encumbrance: 85/20.

**Figlini:** A medium anti-tank weapon, fielded during the latter part of the 21st Century. The Figlini is a tripod mounted, laser guided system that can effectively engage armor out to a range of 2000m. Additional rounds cost 3500cr each. Encumbrance: 60/10.

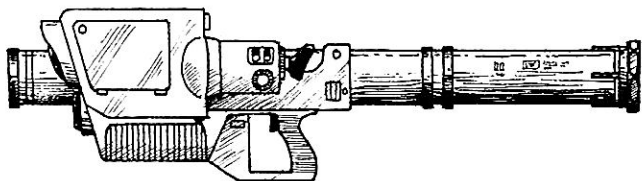

**PLG:** With the advent of Flex steel technology, commanders were faced with the problem of engaging Tech level 4 armors. The PLG is a super-heated plasma round that is fired at enemy armor. A tank's structural threshold is reduced by 2HP when determining penetration. This weapon system is carried into combat by two men where it is assembled. The PLG is designed to engage enemy armor units out to 1700m. Set up time: 1-4min. Additional rounds cost 4000cr each. Encumbrance: 75/10.

**Bonoir Missile:** This supersonic missile is the leading tank killer on Battlefields today. The round has a 15% chance to penetrate flux shields outright. The system is shoulder fired and comparatively light for a weapon of its caliber. It has an unprecedented range of 5000m. Missiles cost 50,000cr a piece. The Bonoir is limited in availability. The parent company, Mining Consortium Unlimited, is currently expanding production to meet the heavy demand for the Bonoir. Encumbrance: 14/6.

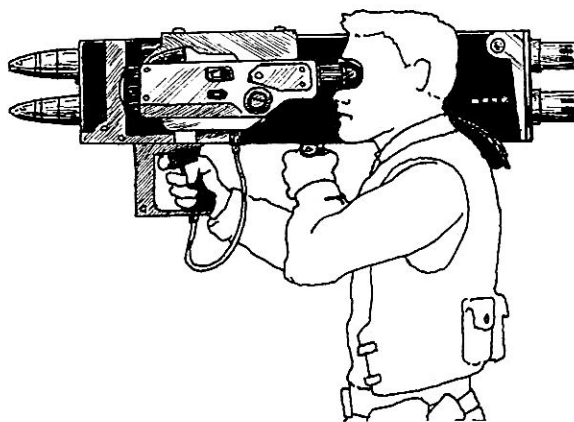

**HAW-4:** This weapon can knock out most tanks in a single shot. The HAW-4 is the heaviest anti-tank weapon currently on the market. Each missile costs 45,000cr. Effective Range: 3800m. Encumbrance: 90/10.

## PERSONAL MISSILE SYSTEMS (PMS)

Personal Missile Systems were designed so that light infantry could effectively engage heavy armor at long range. Characters may purchase guidance packages and payloads separately. The PMS launchers have radar guided enhancement computers that boost the guidance system's chance to track the target. The system is set up on the ground and can be remotely activated from up to 2000m. The guidance system's number is added to the enhancement number to determine the overall chance to strike the target.

**Ballistic-8:** Carries the most advanced enhancement unit on the market, rated at +40 to guidance rolls. Setup Time: 1-4 minutes. Encumbrance: 22.

**Pershing 2:** Named after the controversial weapon system deployed by the United States at the end of the 20th Century. The Pershing 2 launcher adds a +10 to missile guidance checks. It is reasonable efficient and thus cost effective. Setup Time: 1-6 minutes. The system makes for wonderful video games. Encumbrance: 24.

**Minuteman:** Deployed by the Missile Management Corporation. This launcher adds a +20 to guidance system checks. This launcher can fire up to 3 missiles simultaneously and has an ECCM computer rated at 32%. The Minuteman also comes with signal blanking to prevent the enemy from firing a radar tracking missile at the owner (+30 to all dice rolls). Setup Time: 1-4 minutes. Encumbrance: 20.

**GTL:** The acronym stands for Gatling Tube Launch. It is the only multi-missile launch system on the market. ECM/ECCM: 25%; Signal Blanking: 47%; Radar Enhancement: +35%; Ripple Launch: 12 missiles in 3 seconds; Setup Time: 8 minutes. Encumbrance: 48.

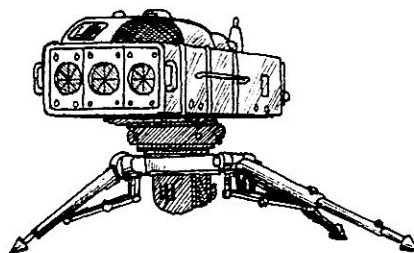

## PAYLOADS

Personal Missiles are 56cm (18 inches long) and weigh 1.4kg (3 pounds). They are generally carried in a shock proof case which attaches to the base of the launcher. It takes 3-12 seconds to load a missile.

## Hand Weapons

**High Explosive:** Does 20-70 points of damage and reduces armor integrity by 12 points.

**Kill Master:** Does 30-120 points of damage and reduces armor integrity by 25 points.

**Radial:** Carries small warheads that blanket a 20m area on contact, doing a collective 20-80 points to anything within the circle.

**Biological:** Delivers the deadly AXT-31B virus, which attack the body's cells, causing them to die. Victims must make an SMR vs biological attack forms or suffer 2-20 points of damage and expire within 2-12 hours. Those who make their SMR take 1/2 damage. Bodily damage occurs at a rate of 1 point per minute, immediately following exposure.

**Chemical:** Delivers a blood agent which removes oxygen from the body. Victims who fail their SMRs suffer 3-30 points of damage. Bodily damage occurs at a rate of 2 points per minute.

## GUIDANCE PACKAGES

**Standard Guidance:** Rated at 95% accuracy.

**Heat Seeker:** Homes in on the infrared signal emitted by sources that radiate heat. Rated at 97%. It is not effected by ECM.

**Radar:** Homes in on the doppler signature. The guidance system is rated at 115%.

**Ion Controller:** Is not effected by ionic disturbances. The guidance system is rated at 105%.

**Supremacy:** Rated at 125%.

**Supremacy 2:** Rated at 135%. It is the most advanced guidance system on the market.

**Impervious:** It isn't affected by magnetic disruption pulses such as that which occurs during a nuclear explosion. It is rated at 100%.

## ACCESSORIES

**100 Power Scope:** Adds +15 to attack rolls and sighting attempts at range brackets 3-5.

**200 Power Scope:** Adds a +15 modifier to attack rolls and sighting attempts at range bracket 4-6. It can not be employed under range bracket 2.

**400 Power Scope:** Adds a +20 modifier to attack rolls and sighting attempts at range brackets 5-7. It can not be employed under range bracket 3.

**800 Power Scope:** Adds a +20 modifier to attack rolls and sighting attempts at range brackets 6-8. It can not be employed under range bracket 4.

**Starlight Scope:** Magnifies and filters existing ambient light so that the user can target objects at night. Starlight scopes are heavy and have an encumbrance value of 7.

**Infrared Imagery:** All living objects radiate heat energy. The thermal imager detects the difference in temperatures between objects. Cold objects appear black, while warm objects stand out as a bright red.

**Bow Sight:** This computerized device greatly enhances the ability of the Bowman to target prey. It adds a +20 modifier to all attacks within range brackets 3-5.

**Tripod:** Helps to stabilize the weapon, adding a +07 to all attack rolls.

**Silencer:** Dampens the noise signature of a discharging archaic powder weapon. Silenced weapons can not normally be detected beyond 7m. The flash is also suppressed.

## AMMUNITION

**Arrow (normal):** Does 1-4 points of body damage. Encumbrance: 4 per quiver of 20.

**Arrow (armor piercing):** Treats armor threshold as 1 point lower than the actual value. Armor piercing arrows do 2-5 points of damage apiece. Encumbrance: 4 per quiver of 20.

**Arrow (explosive tipped):** This special arrow carries an impact-explosive tip that reduces armor integrity by 3 points per hit and does 3-12 points of damage. Encumbrance: 5 per 20.

**Bolt (normal):** Fired from a crossbow. Encumbrance: 3 per quiver of 20.

**Bolt (armor piecing):** Reduces armor threshold by 1 and does +1 damage. Encumbrance: 3 per 20.

**Bolt (explosive tipped):** Has the same effects as its arrow equivalent. Encumbrance: 4 per 20.

**00 Buck Shot:** The standard buckshot fired from most shotguns. Encumbrance: 3 per 50.

**Solid Slug:** Solid slugs are used for penetration of an armored target. They do reduced damage overall, but are armor piercing rounds and do not suffer damage reduction vs armor. Encumbrance: 3 per 50.

**Birdshot:** Adds a +07 to all attack rolls, at the cost of -1 point to damage dice. Encumbrance: 3 per 50.

**Incendiary Round:** Reduces armor threshold by 1 and adds +1 to all damage dice. Incendiary rounds are quite expensive and can only be purchased for 5.56mm and 7.62mm ammo. The cost for a box of fifty is seven times the cost of a normal box of ammo. Encumbrance: 3/4 per 50.

**Hollow Point:** Almost useless vs body armor. The threshold value has two points added to it when determining damage. However, hollow points gain a +2 to damage dice when employed against body tissue. They cost two times the normal cost of a box of ammo, but leave spacious holes in your targets. Encumbrance: 4 per 50.

**Mercuric Rounds:** These bullets are illegal to own and hard to find. Phentari and Eridani are especially susceptible to mercuric poisoning, -10 to SMRs. The cost is 20 times the cost for a normal box of this ammo. Encumbrance: 4 per 50.

## MORTARS

A mortar is a weapon used to lob explosive rounds at a target from long range. It is a tube shaped device with an adjustable armature assembly for ranging. Mortars are primarily used as support weapons and are designed to knock out hardened enemy targets and to disrupt infantry assaults. There are two types of mortars, flat trajectory and high trajectory. Flat trajectory mortars have superior accuracy, but are short range weapons. While high trajectory mortars give up the accuracy for extended range and a higher flight path. The damage done by a mortar depends on the type of round used.

High mortars may be fired as direct fire or indirect fire weapons. Flat trajectory mortars may only be fired in direct fire mode. Using the mortar in the direct fire mode requires that the user be in the line of sight of the target. In the indirect fire mode, the mortar and crew are out of the direct line of sight of the target and a spotter is used to relay information, regarding the impact point of the outgoing rounds. The

chance of the mortar striking the target is increased by 10% per round that misses. The radioman declares "fire for effect" when the rounds first begin hitting the target. He gives the relative location of the landing mortar so the crew can adjust for error. Once the radioman declares a hit, the crew need not adjust the tube further. All additional rounds will automatically strike the location.

Mortars function under the same rules as grenades. The percentage chance to hit depends on the range. The fragmentation range brackets are the same, as is the concussion radius. Thus concussion damage out to 2m would be 100%, and 50% at 4m, etc. An 81mm round costs 200cr and a 110mm round costs 350cr. The 81mm round has an encumbrance value of 4 and does 3-18 points of damage per fragment and 2-12 concussion, while the 110mm round has an encumbrance of 5 and does 4-24/3-18.

**M29:** The standard mortar used by infantry units during the Vietnam War. It is portable and can be carried by one person. A favorite of guerrillas and terrorists. The M29 is not exceptionally accurate. Fires the 81mm round. Encumbrance: 15.

**M110:** A heavy mortar moved on a two wheel chassis with a flat trajectory configuration. The M110 can be fired in two different ways, drop action or lever fire. Some shells use rocket assisted rounds which double the range of the system. Fires 110mm rounds.

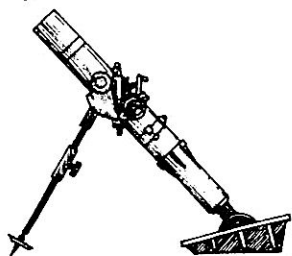

**M210:** Mounted on light armored vehicles. This high trajectory mortar has a range of 6000m. The heavy round produces good damage yield. Fires 110mm rounds.

**Pincheau ML2:** Invented by Cherice Pincheau for the Republic of France in 2065. This was the first attempt at a twin tube scattered mortar. A computerized range dispersion device allows the launcher to scatter rounds over the target area at long range. This high trajectory mortar uses 81mm rounds. Encumbrance: 20.

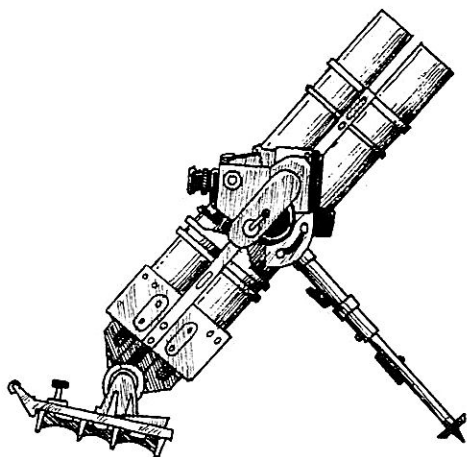

**Pincheau ML3:** An improved version of the ML2. Better accuracy and the Pincheau ML3 contains a built in auto loader.

**MOR-1 (Mortar Optical Remote System):** Fielded in 2090, the MOR-1 was the first attempt at a double remote, "look and shoot" mortar. The MOR-1 was developed by Larcen Electronics Corporation in conjunction with Hampton Optics. It is a high trajectory mortar and utilizes an auto-feeder to load munitions. The rounds are loaded into the side of the mortar tube through the access port by means of LAAS (Loader Access Ammunition System). A computerized armature assembly pushes the round through the access port. The tube drops the mortar onto the firing pin and the round is ejected from the chamber. Pressure builds up inside the tube and prevents the access port from re-opening.

The mortar uses a Jump Camera to target remotely. The camera is put in activate mode when the mortar is first set up (2-5 minutes). Afterward, the operator leaves the area. From a remote distance of up to 5km, the operator can control the camera. The operator raises the camera up by firing thruster rockets mounted on the camera's base. The camera has an altitude ceiling of 70m. The operator sends electronic commands to the camera via the control box, while the camera scans in the specified direction. The operator views potential targets through the eye of the camera. As the camera moves, electronic signals are also sent to the mortar tube from the control box. Consequently, the mortar tube moves to follow the camera. The operator fixes on a target then switches the control box to the enable position. Information, regarding distance and elevation is now fed electronically to the mortar. The mortar adjusts in response. The MOR-1 is now ready to fire. The operator pushes the enable button and a round is ejected. The system suffers from malfunction problems, but is fairly effective. The MOR-1 uses 81mm ammunition.

**MOR-3:** A better system than its predecessor. The malfunction number has been increased. The targeting system allows for priority ranging. The camera automatically adjusts to track the closest target. This system has infrared targeting for night and holds 20 81mm rounds.

**MOR-4:** Still another improvement was made to the optical remote targeting mortars. The MOR-4 uses 110mm rounds.

## SPECIALIZED WEAPONRY

**Taser:** Also known as the "stun" gun. It fires a small needle, charged with 20,000 volts of electricity. Victims must save vs electrical attacks or be immediately knocked unconscious. The Taser has one major flaw; It has a maximum range of 7m. If you like splattering Mazians, this is the weapon for you! After all it does 2-8 damage to their globular masses. Encumbrance: 3.

**Sonic Disruptor:** Resembles a pistol, but the end of the barrel is of a conical configuration. This device fires an ultra-sonic pulse. The sonic pulse dissipates over long distances. Any individual not protected against the effects of sonic disruption must roll on the survival matrix table vs sonic disturbances or take damage. The following table designates the amount and type of damage that an individual receives in the event of a sonic attack. Roll a SMR vs sonic attacks; the difference between the roll and the SMR is cross referenced below.

**Success:** A sharp ringing in your ears.

**Failure by:**

- 1-10: Disorientation: -20 to all skills.
- 11-20: Temporarily deaf: 1-4 min.
- 21-30: Disorientation: -40 to all skills.
- 31-40: Stunned: unable to act 3-12 sec.
- 41-50: Stunned: unable to act 1-4 min.
- 51-60: Stunned: unable to act 3-12 min.
- 61-70: Unconscious for 1-4 hours.
- 71-75: Permanent Deafness.
- 76-80: Hemorrhaging: take 2-5 damage.
- 81-85: Brain Damage: Lose 2-20 I.Q. for 2-8 hours.
- 86-90: Brain Damage: Lose 2-8 I.Q. permanently.
- 91-95: Coma: Lose 2-20 I.Q. permanent, and die 2-8 min.
- 96-100: DEATH: brain is mushed and oozing out your ears.

## Grenades

**Energy Mace:** Designed by the Buddon Priests. The light mace generates a spherical flux shield at the end of its 30cm shaft. This weapon does tremendous amounts of crushing damage and threshold is ignored when calculating damage. All damage is translated directly to the absorption layer of the armor. This weapon has a parry rating of 25%. Other weapons parry it at -25% due to its ability to wrap around the weapon shaft. Encumbrance: 5.

**Light Sword:** This weapon is actually a plasma sword. It is called a light sword because it continuously gives off electromagnetic radiation in the visible spectrum. The plasma field is contained within a magnetic flux force field. Whenever the sword inflicts 1/2 of the target's body points, it cuts clear through whatever was in the way. As they say... It slices, it dices, it severs and maims. Use the blade the ancient Buddon Priests used to cut their meat. Encumbrance: 6.

### GRENADE LAUNCHERS

**M-203:** Designed to be mounted underneath an M-16 rifle. It is a pump action grenade launcher fielded during the Vietnam conflict. The M-203 can only be mounted on archaic hand rifles with some modifications. Reload Time: 2-8 seconds. Effective Range: 150m. Encumbrance: 5.

**M-75 Auto Grenade Launcher:** The magazine holds 6 rounds. It has excellent range and good overall stats. The M-75 can be mounted under any pulse or Omega weapon. Effective Range: 250m. Encumbrance: 5.

**M-L50:** Takes 3-12 seconds to reload each round. It is compatible with most modern weaponry. Effective Range: 200m. Encumbrance: 6.

**Turbo Plus:** The only grenade launcher system that utilizes a turbine engine. Rotating cylinder holds 12 rounds. This unit can fire 2 rounds every second. Reload Time: 2min. Effective Range 250m. Encumbrance: 10.

### GRENADES

Grenades were first invented back in the Middle Ages on the planet Earth. They are small explosive shells whose usage varies with the type of munitions. Some grenades are thrown while others are fired from a launcher. A normal individual can hurl a grenade about 25m. Grenade launchers can deliver a round at up to 200m. Unless otherwise stated, a grenade can be thrown 1/2 one's strength in meters.

The percentage chance to hit an object primarily depends on the range to the target. It is modified by Throwing skill. A character makes an attack roll. Success indicates that the grenade has landed within 2 meters of the target. This constitutes a direct hit. Victims are automatically struck by 8 fragments and suffer concussion damage. A miss indicates that the throw landed some distance from the target. To determine where the errant throw landed, first roll a d12. The resulting number indicates the clockwise direction from the target. Next, the distance from the target is determined by subtracting the basic percentage to hit from the actual dice roll. Then divide that number by 5. The final number equals the distance that the grenade landed from the intended target (expressed in meters.) Round all fractions down. Fragmentation damage decreases with distance from the intended target. For every meter beyond 2, subtract 1 fragment from the maximum number of 8. Thus, if a grenade lands 3 meters away, the victim is struck by 7 fragments. Someone 5 meters away is struck by 5 fragments. Concussion damage is 100% at one meter, 50% at two meters, and 25% at 3 meters. Concussion damage is not reduced by armor threshold. Concussion damage is distributed evenly to all armor locations.

**Example:** Henry the Mutzachan throws a grenade at our friend Fredd the Python. The range is 20m. The percentage chance to hit at that range is 70%. Henry has two levels of Throwing Skill. Each level provides a 04% accuracy modifier to dice rolls for a total of 78% chance to hit. Henry needs a 78 to hit Fred. Henry rolls a 98. He misses. A

12 sided die is now rolled. The result is a 6. The grenade landed directly behind Fredd. The distance from the grenade to Fred, equals  $(98-78)/5$  or 4 meters. Fredd is struck by 6 fragments and suffers no concussion damage.

All hand thrown grenades have a counterpart which is fired from a tube. The launched grenades have a smaller charge yield (6 fragments instead of 8), but otherwise produce the same effects. Only the hand held grenades are described. Both types are listed. All grenades have an encumbrance value of 1, unless otherwise stated.

**M-75 (fragmentation grenade):** Pineapple configuration. This grenade was popular during World War 2. The pineapple configuration has advantages for its dispersion matrix (9 fragments).

**M-85 (fragmentation):** Was standard issue to combat troops in the latter part of the 20th Century. The M85 has a higher explosive charge than its predecessor.

**M-95 (fragmentation):** Fielded in 2055, it is still used in Tech Level 4 societies or below.

**Plasma Grenade:** Rips up armor! It is by far the best grenade on the market. Throwing range is 1/3 one's strength in meters. Encumbrance: 2.

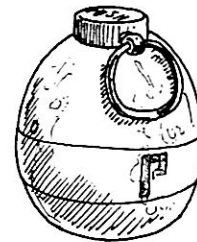

**Super Plasma:** Made specifically to take out guys in heavy armor. It can only be thrown 1/4 of one's strength in meters. Encumbrance: 3.

**Plasma Seduction:** Designed by the renowned physicist Brett Miller. It isn't cost/effective but if you are into overkill then its definitely the grenade for you. Unlike other grenades, it releases 10 fragments per hit scored. It can be thrown 1/6 of one's strength in meters. Encumbrance: 4.

**Molotov Cocktail:** The name given to a glass container filled with some type of volatile liquid that ignites when in contact with fire. The container is plugged, typically with a fuel soaked rag. The rag is lit and the bottle thrown. The glass breaks and the fuel ignites.

**P-4:** The P-4 grenade is known as "Willie-Pete." The grenade contains chunks of white phosphorous which ignite when exposed to oxygen. Phosphorous burns at such a high temperature that it melts through armor in seconds. Armor threshold is effectively reduced by 2 points when determining penetration damage. Armor integrity is reduced by twice the stated number of fragments that penetrate. Phosphorous incinerates flesh, leaving horrible 3rd degree burns.

**T-3 Blinder:** Is a good grenade for assassins and thieves. The Blinder contains magnesium powder. Any person caught looking in the direction of the grenade when it explodes is temporarily blinded. This state lasts from 2-8 minutes. Potential victims receive a SMR check vs radiation attacks. A successful roll indicates that the individual has avoided being blinded. There is a 10% chance of being permanently blinded, 15% for Cizerack types, 05% for Python classes.





**CS-7:** Known as the riot control grenade. The explosion produces a noxious gas that incapacitates any individual who fails his SMR vs poisonous attack forms. The victim must make a roll every 10 seconds, until he has escaped the area. The gas cloud expands at a rate of 1m per second for 30 seconds. Environmentally contained armor negates the effects of the gas completely.

**M-80 Smoke:** Used to provide cover for moving troops. This grenade gives off thick, colored smoke when detonated. Be careful to determine wind direction before throwing. Sighting checks made through smoke incur a -60 penalty. Attack rolls are made at a base -30 penalty. Smoke grenades are often used as position markers.

**M-90 Concussion:** Designed to damage buildings and vehicles rather than personnel.

**Omegaton:** It makes an incredible BOOM!!! Double all concussion ranges. It can be thrown 1/4 of one's strength in meters. Encumbrance: 3.

**BX-1 (biological):** Contains a liquid that is filled with biological organisms, usually the Virean Plague. Infected characters must make a SMR vs biological attack forms at -10 to the dice roll or die within 2-8 days. There is also a 50% chance that the character becomes a carrier of the disease, regardless of whether or not the victim is infected. The viruses employed are USUALLY short lived without a host. This helps to reduce clean up problems immensely.

**CR-3 (chemical):** A blister agent is dispersed upon explosion. Drops that strike exposed skin, fester into huge oozing blisters and quickly incapacitate the victim. The liquid is misty and can also be inhaled. Those individuals who inhale it develop the blisters in the lining of their lungs. Victims of a Blister Agent attack must make successful SMR vs chemical agents or take 4-16 points of chemical damage.

**M-200 series:** These grenades are designed to be used with grenade launchers. Other grenades may be converted to use with grenade launchers but cost four times as much.

## MINES

Demolition experts have a need for a variety of mines. A properly placed anti-personnel mine can wipe out an entire party. Below are listed the different types of mines and detonators currently available. It the author's opinion that parties should carry a couple of different types. Mines can be used to lay minefields in order to slow down or stop advancing enemy personnel. For every mine placed in a 5x5 meter area, there is a 4% chance that an unsuspecting individual will step on one, and we know how that can ruin their day. Mine fragmentation is treated the same as grenades (i.e. 8 fragments).

**Bouncing Betty:** Not designed specifically to kill, but more to mangle enemy personnel. The enemy steps on the pressure release switch. The mine bounces upward 1m and detonates, generally relieving the individual of his or her internal organs. Integrity Reduction: 1/Fragment. Encumbrance: 3.

**Chemical Mine:** Pressure released, the explosion gives off a chemical nerve gas. Individuals not properly protected, must make a SMR vs chemical attack forms or take 3-18 points of damage. A successful SMR completely negates the effects of the gas. A SMR is made for every 10 seconds of exposure. Encumbrance: 3.

**Claymore Mine:** Used extensively by American troops in the latter part of the 20th and the early part of the 21st Centuries. Claymores are devastating against personnel and can be set up as far as 50m from the owner. They are connected to the activation switch by a wire. The soldier takes the safety off and bangs on the activation switch three times. Drawback: It takes an average of three minutes to set a Claymore up. Integrity Reduction: 1/Fragment. Encumbrance: 2.

**Claymore 3:** An improved version of the Claymore. First widely used in 2005. Integrity Reduction: 2/Fragment. Encumbrance: 2.

**E4 Tank Killer:** Anything over 450kg mass triggers the E4. Ram Pythons beware! Encumbrance: 20.

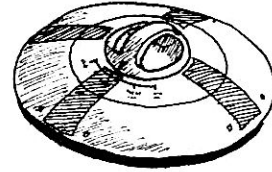

**Light Mine:** This mine is either radio or pressure release activated. It does no explosive damage, but emits a brilliant light that automatically blinds anyone within 5m of the explosion who happens to be facing in the direction of the blast. There is a 50% chance of being blinded from 06-10m from the flash. All victims within 5m have a 05% chance of being permanently blinded. Chatilians have a 10% chance to be blinded, due to the sensitivity of their large eyes. Blindness lasts for 2-12 minutes. Encumbrance: 2.

**Needler Mine:** A body armor penetration mine. The Needler can be activated by any means. When the mine explodes, small titanium steel pins fire out in every direction. Body armor has three subtracted from its threshold rating when determining damage penetration. Needler mines have absolutely no effect on Heavy Armor. Victims are struck by 4-16 pins each, and each pin does 1 point of damage. The overall armor integrity reduction is 25% of the number of penetrating pins. Encumbrance: 3.

**Nuclear Mine:** The most devastating of mines. It is radio or pressure activated. The detonation automatically kills anyone within 100m, unless the person can survive 20-120HP of damage from heat, fire, and blast damage!!! Victims, within 101-250m, take 2-8 heavy points of damage. Between 251-400m, one takes 30-120 points of damage. Beyond 400m, there is no fire/blast damage; however, all persons within 1000m must make an SMR versus radiation or die within 2-12 minutes from intense Gamma emissions. Protected characters take no damage from radiation, but are still subject to blast, heat, and fire damage. The radioactive material has a short half-life and all radiation dissipates within two hours. Problem!!! It is illegal to possess one of these. The penalty is death. So it is a little hard to find them. Can't imagine why, can you? Encumbrance: 30.

**Plasmore:** Designed to take out you "tough guys" who wear heavy armor. Each fragment reduces armor integrity by 4 points. Encumbrance: 3.

**Sonic Mine:** This mine is activated by a radio transmitter. It gives off a supersonic concussion blast and all persons within 05m must save versus sonic attacks or take 2-12 points of damage. Those victims standing within 10m must make a sonic SMR or be struck unconscious. Encumbrance: 2.

**Tangler Mine:** Designed to entangle or capture enemy personnel. The mine is pressure activated. When it explodes, the tangler fires hundreds of small adhesive nylon cords in all directions. The effect is to entangle personnel. Any exceptionally strong character has a 02% chance per point of strength above 100 of escaping. Encumbrance: 3.

## EXPLOSIVES

**Dynamite:** Is an archaic explosive in a stick form. It does a fair amount of damage. A full 03% of all sticks are "duds."

**C-4:** Potent explosive developed for military demolitions in the 20th century. Portable and easy to use.

**Jellnite:** Powerful, yet controlled. Jellnite is used primarily in space.

**Nitro-7:** A dangerous and very volatile explosive. Nitro-7 comes in liquid form. It is poured over the surface and hardens within a minute. Any sharp jarring of the Nitro-7 while it is in liquid state can cause it to detonate prematurely (10% chance).

**Villanite:** The most powerful explosive ever produced. A couple of healthy sized putties can reduce a building to rubble in seconds. Villanite is heat sensitive and exposure to high temperatures can cause premature detonation. Store at temperatures of 5C/40F or less.

## DETONATORS

**Multi-step:** Allows for the simultaneous detonation of up to 10 different charges at one time.

**Plunger:** This detonator malfunctions often, but costs almost nothing. Encumbrance: 5.

**Radio:** Range 6000m. The explosive is set off by receiving the frequency command from the transmitter. Different frequency prongs can be purchased. Encumbrance: 2.

**Sonic Detonator:** Sonic threshold sensitive. Any noise above a certain threshold triggers the explosive. There is a 30 second delay so that individuals can escape the area before the detonator begins monitoring.

**Timer:** An electrical charge sets off the explosive at the prescribed time.

**Electric:** Detonates the charge by sending an electrical charge through the explosive. Time delay.

**Fuse:** The oldest (and least reliable) method of ignition. Strike a match and it burns its way to the charge. That is if it doesn't go out on the way. 5% chance.

## MISCELLANEOUS EQUIPMENT

Any intelligent adventurer realizes that he needs more than just his gun. The following section provides extra accessories that adventurers can purchase. It is the author's opinion that a compass and flashlight are things which must be bought. Characters might also consider purchasing 20m of rope. Oh and for those of you with violent *Battle Masters* (*Editors' note:* Like Larry Sims), a BRI or 20 might come in handy...

## DETECTION EQUIPMENT

**Binoculars:** Standard Binoculars add a +20 to sighting checks for range brackets 3-7. Maximum range: 750m. Encumbrance: 2.

**Binoculars (infrared):** Infrared imaging binoculars register heat sources. The ambient temperature of living creatures is higher than that of ground surfaces. Binoculars allow an individual to locate living objects at night and track them. The unit adds a +40 to night sighting checks. Encumbrance: 2.

**Binoculars (long range):** Can not be used under 50m. They add a +30 to sighting checks for range brackets 4-8. Maximum Range: 2000m. Encumbrance: 2.

**Binoculars (night-vision):** Allow individuals to see in near darkness, by amplifying ambient light. The user makes normal sighting checks. Encumbrance: 2.

**Binoculars (wide angle):** The wide angle GR-2 binoculars come with an adjustable parabolic mirror that can spot a man sized object out to a distance of 300m. These binoculars add a +50 to sighting checks at range brackets 1-6. Encumbrance: 2.

**Bio-Scanner:** Detects the presence of life forms. The scanner utilizes bio-electronic technology to determine basic physiological makeup and medical condition of the lifeform. Size: 15cm x 20cm. Range: 25m. Encumbrance: 3.



**Bug Finder:** Detects the frequency transmissions of surveillance equipment. Size: 3cm x 4cm x 4cm. Range: 200m. Encumbrance: 2.

**Bug Killer:** Determines the location and fires a small electromagnetic disruption pulse at the bug. 80% Effective. 10 Charges. Size: 4cm x 4cm x 2cm. Range: 100m. Encumbrance: 2.

**D3-A Scan Unit:** Designed to combat the infiltration of Mazians into top secret government complexes, the scanner detects the emanations of an amoeba's brain waves. 75% effective. Size: 20cm x 30cm. Range: 100m. Encumbrance: 6.

**DD-48 Vaporizer:** Detects the aerial presence of poisonous and noxious vapors. An alarm is sounded upon detection. Size: 10cm x 10cm. Range: 50m. Encumbrance: 3.

**Goggles (Infrared):** Lets a person see into the infrared portion of the electro-magnetic spectrum. The wearer can see near by heat sources and IR signaling devices.

**Goggles (Ultra-Violet):** Allows a person to see into the ultraviolet portion of the spectrum. This improves night vision and allows the wearer to see ultra-violet signal devices like UV flares.

**Infrared Spotlight:** Infrared spotlight are used to illuminate a large area, picking up and visually labeling all objects that radiate heat in the infrared portion of the electro-magnetic spectrum. It has a wide angle beam with a range of 100m. The mouth of the beam is 20m across. Encumbrance: 40.

**Metal Detector:** Used to detect the presence of metals. It can detect objects up to 15m below the surface. Encumbrance: 20.

**Mood Discriminator:** This device is actually a ultra-sensitive electro-encephalogram which measures the activity in the brain. It discriminates between moods and is used to pick out potential enemies. The discriminator appears as nothing more than a lighter sized object. Range: 50m. Encumbrance: 1.

**Motion Detector:** This is not the same as a bio-scanner. It picks up any motion, providing range and vector (speed and direction). It is useful against robots. Most walls or similar obstructions have no affect on this device, which filters out ground clutter. Range: 50m. Encumbrance: 3.



## Equipment

**Plastic Explosives Detector:** Detects the vapor emissions of plastic explosives. Good against villanite, jellnite, C-4, etc... Range: 17m. Encumbrance: 3.

**Pocket Jammer Detector:** Detects the transmissions of an electronic jammer. Size: 5cm x 5cm. Range: 32km.

**Radar Detector:** Detects radar transmissions. A filter locks out extraneous signals. Most radar detectors are 90-95% effective. They provide range, relative air or ground speed, and travel vector. Range: 160km. Encumbrance: 3.

**Sonic Amplifier:** A portable unit used to amplify sound. The system consists of a parabolic microphone and a headset receiver. The microphone is pointed in a given direction and picks up sound waves within a 45 degree arc. The sonic amplifier can detect the sonic emissions of a man sized creature at 100m and armored vehicles at up to 5000m. Encumbrance: 4.

**Sonic Discriminator:** This miniature computer is attached to the headset of a sonic amplifier. It's about the size of a cigarette lighter. The computer interprets the modulations and frequency distribution of sound waves. It has a base 90% chance of determining the type of sonic emission. The interpretation is broadcast vocally through the headset. The computer provides target range, speed, and travel vector. Size: 15cm x 12cm x 8cm. Encumbrance: 3.

**Transmission Jammer (portable):** Disrupts the transmissions of radios and other communication/control devices. Disruption is created by "white noise" generation. In other words as the radio speaks the jammer "yells" incoherently and drowns out the radio's transmission. Size: 10cm x 12cm x 5cm. Range: 16km. Encumbrance: 3.

**UV Flare:** This device is set in the ground with a trip wire fixed to some other point. The flare gives off a light, registering in the ultraviolet spectrum, when tripped. Encumbrance: 2.

**Vibro Rod:** A ground sensory device which amplifies sonic waves that propagate through a dense medium such as the ground. The rod is stuck into the ground and its vibration sensors detect the movement of man sized creatures at a range of 500m or less, and armored vehicles out to 2km. Size: 50cm x 5cm x 5cm. Encumbrance: 7.

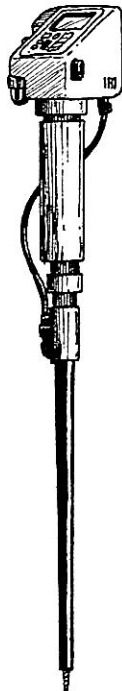

## ESPIONAGE EQUIPMENT

**Acidizer:** A small pistol-shaped device designed to squirt controlled amounts of hydrochloric acid into locks. The gun is constructed of Steel Glass. It is used to burn through locks and doors, and stores enough acid for 10 uses. The owner need not worry, the weapon can not be broken by any ordinary means. Refills: 75cr. Encumbrance: 3.

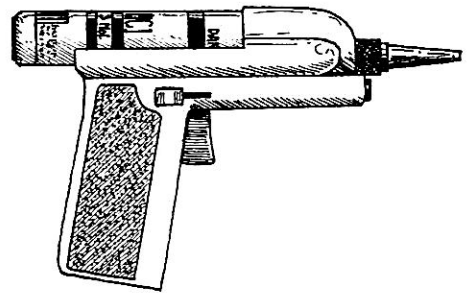

**Blow Torch:** Used to cut through panels and heavy metal barriers. The acetylene fuel lasts for about 20 minutes on high flame. Encumbrance: 2.

**Cam Flybot:** A remote sighting, flight surveillance robot. The system incorporates a sensitive camera system which uses an 800mm auto zoom focusing lens. Altitude: 3000m, max speed: 80kph, vertical climb: 7m/s. Maximum altitude reached in 2.7 minutes. Range: 400km. Encumbrance: 200.

**Camera (35mm):** The modern camera is an advanced version of its archaic predecessor. This system uses electronic imagery to take photographs. The image is stored in the camera's micro-memory and developed by a computer image enhancement process. It comes with a standard 50mm lens. Other lenses are available. Encumbrance: 2.

**Contact Microphone:** A dime size surveillance device that can be attached to any smooth surface. Transmission range: 1000m.

**Electronic Tracer Device:** Transmits a low band frequency up to a range of 7000m. An adhesive strip is taped to the car bumper. The tracer is battery operated with a continuous broadcasting transmission for up to 120 hours. Encumbrance: 2.

**EV-1 Mole:** A large, cylindrical robot mounted on treads. The robot is designed to dig tunnels through all but the toughest of rock. The Mole can excavate a tunnel about 1 meter in diameter, and tunnels through soft dirt and clay at a rate of 3 meters per minute, normal rock at a rate of 1 meter every 3 minutes, and bedrock at a cumbersome 1 meter every 6 min. Encumbrance: 200.

**Infrared Dampener:** This device reduces the heat signature produced by warm blooded creatures. As a result, all infrared sighting checks are reduced by 30% when attempting to locate a person with an IR dampener. Encumbrance: 4.

**Jump Pads:** Designed in the latter part of the 22nd Century, it enables the wearer to leap distances of 10m from a standstill and up to 20m with a running start. These boots utilize a short duration anti-grav propulsion system. Encumbrance: 2.

**Lock Pick Set (basic):** The set contains 10 lock picks, one tension bar, and one key extractor. The tension bar is used to manipulate the lock picks into position. The key extractor is used to remove broken key parts from the lock. Encumbrance: 3.

**Lock Pick Set (electronic):** A mini digital computer that uses an electro-magnetic field generator to move electronic code key tumblers into place. The thief manipulates the generator field through the digital readout of the computer. This device adds a +35 modifier to electronic lock pick attempts. Also used to change the magnetic code on credit and bank cards. Encumbrance: 3.

**Lock Pick Set (professional):** Has 40 lock picks in a wide range of sizes from 0.23 mm in diameter to 1.14mm in diameter. This set contains two tension bars and 1 key extractor. Encumbrance: 3.

**Mini Camera:** About the size of a cigarette, the mini-cam utilizes electronic imagery to take high resolution photographs. The electronic memory stores 15 exposures. It has automatic focusing.

**Mini Scanner:** An electronic imagery photographer, the scanner functions in a manner similar to a copy machine. It scans one piece of a document at a time, storing the image in its memory for computer reconstruction at a later date.

**Mini Video Camera:** About the size of a cigarette lighter. This unit has auto focus and light adjustment. It is easily concealed and has a running time of 30min.

**Pocket Signal Detector:** Registers and records radio signal transmissions up to 5km from the source. The signals can later be deciphered by a computer.

**Pry Bar:** Heavy metal bar used to force entry into rooms, cars, etc. Encumbrance: 10.

**Wire Cutters (professional):** Designed to cut through heavy steel fences. The unit contains a built-in sharpening stone to prevent dulling. Encumbrance: 7.

**Wireless Remote Mini Cam:** A mini video camera with remote control that acts as a two piece unit. The camera is mounted on a small, rotating tripod. The user scans through the lens of the camera via the display on the control box. The control box sends electronic commands to move the directional servos on the base of the camera. Dimensions: 6cm x 4cm x 4cm. Range: 5km. Encumbrance: 2.

**Wrist Torch:** Looks like a watch, yet conceals a tiny extendable torch. The propane fuel burns extremely hot and it can cut through a 2 inch metal wall panel in 2 minutes. The fuel lasts for 5 minutes. Refills cost 50cr.

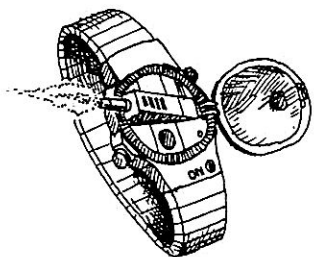

**X-ray Camera:** Experimental unit. The system utilizes high powered gamma rays to take pictures through objects. The X-ray camera can take a picture through 30cm of concrete, 15cm of steel, or 2cm of lead. Dimensions: 8cm x 4cm x 4cm. Encumbrance: 3.

**X-ray Video Camera:** Another experimental camera that uses X-ray imagery to take pictures. This portable unit weighs 1.50kg and has dimensions 15cm x 13cm x 13cm. The X-ray Video Cam has the same object penetration capabilities as the X-ray camera. Encumbrance: 4.

## MEDICAL GEAR

Soldiers often get seriously wounded in combat and are often in urgent need of medical treatment. Player characters should purchase some emergency medical treatment gear before they go out to adventure. The choice between purchasing and doing without can determine the life or death of a warrior. The effects of the equipment are given below.

**Biological Redox Agent:** Reduces the effects of biological attack forms. The redox agent works to protect the body from foreign agents by "beefing up" the immune system. It provides a +20 to biological SMRs. All damage done to the victim is halved.

**Blood Transfusion:** This is an emergency supply of blood plasma for field operations, and emergency transfusions. Each transfusion restores up to 2 points of blood loss.

**Body Cart:** An inertial-grav system used to transport wounded. This gurney is quite functional. The cart travels 1m above the ground.

**BRI (standard):** BRI stands for Body Rehabilitation Injection. It is synthesized from the ganoir plant. A BRI heals damaged tissue subsequent to its injection into the body at a rate of 1 point every two minutes. A total of 1-8 body points can be healed per injection. More than one injection within a 30 hour period can lead to addiction. See MORTALITY for more information. Note: While a BRI will restore damage by stimulating growth and repair it does not set bones or repair serious wounds. Assume that all critical wounds require additional treatment.

**BRI (massive):** A more potent Body Rehabilitation Injection. A massive BRI restores 3-18 body points at a rate of one per minute. Massive BRIs can heal critical wounds.

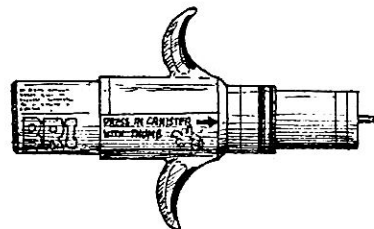

**Chemical Redox Agent:** It is similar to the Atropine injections used by the United States during the 20th Century. The injection is administered to combat the effects of chemical attacks against the body. It adds a +30 to SMRs vs chemical attacks. A maximum of three of these injections can be taken in a 30 hour period without risking cardiac arrest.

**Coolant Injection:** Used to lower the body temperature of Eridani and Phentari who have lost the means to cool themselves. The coolant lasts for 6 hours.

**Cryo Injection:** Places a terminally injured patient in cryogenic freeze. All metabolic functions are lowered to a minimal level. The chance to revive the victim is 95%.

**DNA-6BMR:** Some attack forms alter the genetic structure of the individual's body chemistry. DNA-6BMR is designed to re-map the affected areas. It has an 80% success rating.

**First Aid Kit:** Used to treat minor injuries. The kit comes with 5 gauze bandages, a pair of scissors, tape, a needle, thread, burn cream, and antiseptic. Encumbrance: 2.

## Equipment

**Isolation Bag:** This light weight product is used to isolate victims who have been infected with a dangerous organism. It is also used to keep a sterile environment. It comes with a regenerating oxygen supply. Encumbrance: 6.

**Methane Injection:** Provides the Phentari or Eridani with a 6 hour supply of methane.

**Paramedic Kit:** Has drugs, a defibrillator, EKG, an other necessity required to assist injured victims. It contains 3 massive and 3 normal BRIs. It is not the same as a surgical kit, although they are often used in conjunction. Provides a +20 to resurrection attempts. Encumbrance: 35.

**Perceptual Enhancement Injection:** Raises the state of awareness of the individual's sensory organs by 20% for 2-8 minutes.

**Radiation Treatment Serum:** Reduces the effects of radiation poisoning. Double doses of this drug can be administered to an individual who is dying from heavy exposure, conferring a 50% bonus to SMRs vs radiation.

**Rage Enhancement Injection:** Affects the sensory neurons in the cerebellum, inducing an increased state of aggression. The combatant receives a +10% on attack rolls and +1 to damage dice (when using archaic hand weapons.) The rage enhancement injection allows the individual to fight into the negative body points. The user falls unconscious between -1 and -6 body points. A d6 is rolled to determine the point where the combatant will fall unconscious. Duration: 3-12 minutes.

**Reflex Tablet:** Shortens the time required for messages to cross the neural synapses in the central nervous system of the recipient. The individual gains a -2 modifier to all initiative rolls. Duration: 2-8 minutes.

**Regeneration Serum:** No one is aware of how to reproduce this besides the Zen Rigel. Scientists haven't been able to isolate the causal agent. Lost limbs grow back in 2-8 days. How? Ask a Zen.

**Storage (medical):** This unit is used to keep cold, heat sensitive medical products. It has a cubic foot of room. It contains a foam protective lining which prevents breakage. Encumbrance: 50.

**Surgical Kit (portable):** Field medics are often faced with the need to operate in the field. This kit comes with retractors, spanners, forceps etc, and has a sterilization unit onboard. Encumbrance: 10.

**Truth Serum:** Used to extract information from captured personnel. Thio-pental sodium places the individual in a suggestive catatonic state. Each dose lasts 2 hours. It is 95% effective against beings with normal metabolic functions. The Mazian metabolic structure is such that this drug is only 50% effective when used on them.

**White Count Injection:** The drug Phena-Caratoyl is used to "beef" up an individual's body defenses against infection, poison, and disease. It confers upon the user a +20% modification to disease resistance rolls. Successive doses of this drug increase the body's resistance by 10%, to a maximum of 50%.

## PERSONAL EQUIPMENT

**Atmospheric Processor:** Without it, the Eridani and Phentari could not exist in an oxygen environment. The processor converts an oxygen/nitrogen atmosphere to methane by a complex oxidation process. The processor fits over the mouth and nose. It has a threshold rating of 9 and an armor integrity of 4. Encumbrance: 3.

**Backpack:** You put junk in it! Encumbrance: 2.

**Body Computer:** Interfaces with other computers to convert machine language into its vocal equivalent. Encumbrance: 3.

**Brain Scratcher:** This head massage unit is worn by Chatilians. It massages away headaches and helps an agitated empath to relax. This unit has 3 settings, scratch, rake, and maul! Encumbrance: 5.

**Case (magnetic proof):** Used to isolate magnetic sensitive devices such as computer disks from damage. The case is usually strapped to the waist belt for easy accessibility. Encumbrance: 2.

**Case (shock proof):** Protects fragile items from being damage. A typical glass object has an SMR of 10 vs jarring. Protected items have a SMR of 80. Encumbrance: 3.

**Case (super):** A combination of the water-proof, shock-proof and magnetic-proof cases. Encumbrance: 4.

**Case (water proof):** Protects water sensitive objects. Encumbrance: 3.

**Chem Lab:** This small, portable lab carries equipment necessary to do field work: Contains test tubes, Erlenmeyer flasks, a Bunsen burner, stoppers, chemicals, etc. Encumbrance: 8.

**Compass:** The compass is an instrument for determining directions by means of a freely rotating needle that indicates magnetic north.

**Compass (digital):** Automatically triangulates a person's position with respect to the magnetic north pole. Furthermore, the digital compass provides longitude and latitude in a 8 digit grid coordinate.

**Compass (magnetic):** Unlike the generic version, the magnetic compass is impervious to the effects of magnetic disruption.

**Dummy (practice):** When Eridani can't find live targets to practice on, they use these mechanical dummies which move randomly in a designated area, helping the Swordsaint to hone his skills. Encumbrance: 20.

**Emergency Transmitter:** Used to notify potential rescuers of an individual's position. This small, concealable device emits a radio distress signal. Persons monitoring the Galactic Emergency frequency of 75,003Hz can pinpoint the location of the transmission. Range: 32km.

**Flare Gun:** Use to fire aerial flares up to a height of 66m. A flare floats for 30 seconds and can be spotted at a range of 20km. A box of 5 flares cost 20cr. Encumbrance: 2.

**Flashlight (normal):** A small portable electric lamp, powered by batteries. It has an illumination range of 25m. Encumbrance: 2.

**Flashlight (threader):** The threader flashlight emits a thin beam of light with a range of 100m. It has a flash/blinker for momentary target illumination. It is often used as a signaling device. Encumbrance: 2.

**Grapple Gun:** Used to fire a grapple up to a distance of 35m. Encumbrance: 6.

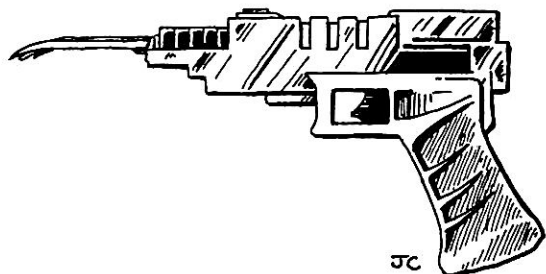

**Grappling Hook:** A barbed metal device, used to secure a rope to an otherwise difficult obstacle such as the top of a wall. It is normally thrown, but can be fired from a gun as well. Encumbrance: 2.

**Grenade Scoop:** This device looks like a 1m long coffee scoop. It has a voice activated magnetic suction that is used to scoop up grenades in the nearby vicinity. The base chance to pick up a grenade is 10% + 10% percent per point of initiative below 5. Agility bonuses also add to the chance to scoop up a grenade on a point for point basis. Encumbrance: 6.

**Holographic Generator (vehicle):** Same as the body version. The generator is protected by 3HP of body armor to ensure survivability. The energy pack holds 42 charges, capable of producing 1-6 duplicates. Each duplicate uses up one charge. Encumbrance: 350.

**IFN:** Stands for Internal Frame Network. The IFN is used by the Mazians to set up the internal skeleton structure of the object that they intend to replicate. This gives the Mazian a +20% modifier to shape change checks. Encumbrance: 3.

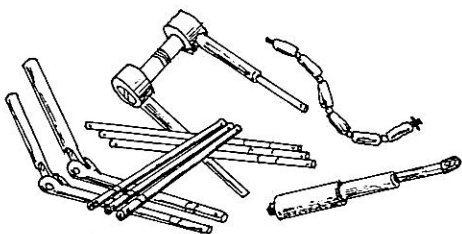

**Mega Glue:** The super glue that does everything! It binds Pythons to metal in seconds! Call before midnight tonight and receive the ACME juicer as a free bonus.

**P-Cabin:** A pressurized cabin with built-in sleeping quarters. It can be erected in 20-80 minutes. The P-Cabin represents the state of the art in outdoor sleeping equipment. Pentagonal configuration. Ground Clearance: 2.3m, wind resistance: 120kph. Encumbrance: 200.

**Parachute (military):** A large umbrella-like device that opens in mid-air, offering a slow, controlled rate of descent. Not very accurate. An altimeter and one way radio are included in the price. Encumbrance: 20.

**Parachute (professional):** A highly mobile and accurate rig. The Mighty Mac allows for landing within 7m of target. This canopy has an excellent turn rating and it also functions well in strong winds. Encumbrance: 17.

**Phent Morsels:** Pre-packaged snacks, cut from the most delicate parts of the Human anatomy. Phent Morsels come in smoke flavored, gravy, etc. Hmmm! Hmmm! Good!

**Pitons (20):** A metal spike through which rope can be passed. It anchors the rope when climbing. Check your paper for coupons.

**Plasma Generator:** Designed as a support device for infantry assault units. It generates plasma for weapons recharge. It can generate the equivalent of 1000 shots per day. There must be a large supply of iron available to fuel the operation. Encumbrance: 780.

**Pneumatic Saw:** This device is used to cut through heavy metal objects. The blade is made of Di-Titanium. The pneumatic saw is capable of cutting through a 10cm thick steel wall in two minutes. Light weight and portable. Encumbrance: 8.

**Polymizer (heavy):** Generates up to 250 points of polymers per day. Requires 10,000 credits worth of Liquid Rubber for operation. Encumbrance: 500.

**Polymizer (portable):** Generates absorption polymers for injection back into a body armor system. It can generate 30 points per day and requires 1000 credits worth of Liquid Rubber for operation. Encumbrance: 35.

**Purification Tablets (food):** Added to food to purify it. The tablets destroy poisonous bacteria. A persistent red color indicates that the purification process is ineffective and warrants additional tablets. Some things can not be purified.

**Purification Tablets (water):** Function under the same premise as the Food Purification Tablet.

**Raft (2):** A lightweight device used to transport objects or individuals over water. It can carry two men and 23kg of equipment. Encumbrance: 20.

**Raft (4):** Carries four men and 68kg of equipment. Encumbrance: 35.

**Raft (6):** Carries six men and 135kg of equipment. Mounts twin Terry class engines. Maximum speed: 70kph. Encumbrance: 45.

**Range Finder:** Provides range, speed, and travel vector of moving objects out to a range of 5000m. Encumbrance: 3.

**Refrigerator (portable):** Stores up to 1 cubic foot of materials. The super-freon coolant lasts for 100 hours of continuous operations. Encumbrance: 15.

**Repellant (bug):** Does what it says it does!

**Rope (standard):** Has a test strength of 6000kg. Normal rope is thick and bulky. Encumbrance: 8 per 20m.

**Rope (flex):** Strong, yet thin. It is made from flex-nylon polymers. Flex rope is 11,000kg test, and it is suitable for almost any purpose. Encumbrance: 3 per 20m.

**Satchel:** A small bag for carrying explosives. Encumbrance: 4.

**SCUBA Equipment:** Comes complete with snorkel, fins, a wet suit, and 2 hour supply tank. Encumbrance: 40.

**Shark (J-7):** Operates in corrosive bodies of liquid. The Shark can carry 10 men and 180kg of equipment. Maximum speed: 100kph. Encumbrance: 40.

**Sleeping Bag:** Down-filled; keeps the person warm down to -23c/-10f. Encumbrance: 7.

**Sleeping Bag (arctic):** Excellent cold weather bag. Thermal heating insulator. Temperature resistance: -59c/-70f. Encumbrance: 7.

**Sleeping Bag (methane):** For our buddies, the Phentari and Eridani. Cools thing down quite nicely for any methane breather who wants to "crash".

**Still (portable):** A favorite of Orion Rogues who consider this basic equipment. Great for those who want to slug down a couple drinks while on the job!! Sets up in just 10 minutes. Encumbrance: 15.

**Stove (portable):** This portable microwave unit is a favorite of adventurers. It gives off no light when operating. There is also a "glove" which fits over the oven while it cooks, lessening the chance of any detection by infrared means. Encumbrance: 5.

**Tablets (protein):** Provides emergency nourishment. Each tablet provides 2 units of nourishment. A box holds 50 tablets.

## Equipment

**Tablets (salt):** Replaces salt in dehydrated individuals. 50/box.

**Tent (2 man):** Triangular configuration, center pole. Ground Clearance: 0.7m, wind resistance: 46kph. Encumbrance: 20.

**Tent (4 man):** Pentagonal configuration. It has a frame body. Ground Clearance: 1.5m, wind resistance: 72kph. Encumbrance: 55.

**Tent (8 man):** Pentagonal Configuration. Reinforced body frame. Ground Clearance: 2m, wind resistance: 100kph. Encumbrance: 100.

**Thwack'em Stick:** A huge (relative to Human terms) stick that the Ram Pythons use as a practice club when they are playing. Most Humans claim that the stick is actually a tree in disguise. The stick register the impact force of a blow in kilogram per meter squared, and km per second. It also plays music! Treat as a club. Encumbrance: 25.

**Tool Kit:** Contains all the tools necessary to repair household goods. It has pliers, screwdrivers, wrenches, a metric socket set, a hammer, etc. Encumbrance: 25.

**Tool Kit (electronic):** The electronic technicians dream come true! The electronic tool kit comes with soldering iron, magnetic coupler, magnetic isolators, logic probe, and a multitude of spare parts and circuit boards, etc. Encumbrance: 35.

**Tool Kit (ionization engineer):** It has who-ja-macallits, thing-a-mabobs, widgets, bigger widgets and other stuff! The kit travels on an inertial grav system, otherwise it would be impossible to move. Encumbrance: 30.

**Tool Kit (masters):** The preferred tool kit of mechanics. There are a wide variety of tools in this 3 level kit. There are torque wrenches, spanners, isolation bars, a tap and die, and just about anything that a vehicle mechanic would use. Encumbrance: 100.

**Web Gear:** Body harness worn into combat. Web gear comes with a belt, suspenders, two ammo pouches, canteen cup, and first aid kit. The canteen holds 1 liter of water. The first aid kit has one sterilized bandage. The individual pieces cost 15cr, 10cr, 10cr, 5cr, 2cr, and 5cr respectively. The entire unit is only 40cr. Encumbrance: 4.

## ENVIRONMENTAL HAZARD GEAR

Combat types often find themselves in hostile atmospheric conditions where a biological, chemical, or radioactive agent is present. Characters who believe that they may be faced with the prospect of operating in such an environment should purchase equipment accordingly.

**Chemical Alarm:** A small, hand sized device, used to detect the presence of a hazardous agent. The alarm sounds a loud high pitched pulse. Encumbrance: 2.

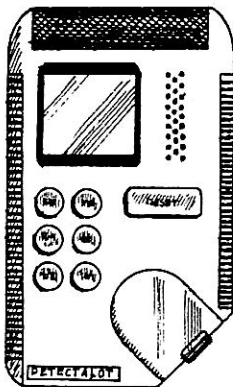

**Chem Goggles:** Detect the presence of chemical, biological, and radioactive agents. The agents appear in different colors, depending on the type of agent. Range: 500m.

**CS-4 Chemical Suit:** Chemical Suit used in conjunction with the GM-4 mask. The CS-4 protects the body from contamination at the 200 micron level. Any puncture ruins this suit. Both units can be purchased together for 75% of list cost. Cost: 500cr. Encumbrance: 12.

**CS-7 Chemical Suit:** This unit has a thin, flexible, plastic outer skin that prevents tearing. The suit protects the body at the 100 micron level. A basket purchase for the CS-7 and CS-4 costs 950cr. Unit cost: 700cr. Encumbrance: 14.

**Decon Kit:** This spray gun is designed to clean off contaminated equipment. It stores 10 applications. Refills cost 70cr. Encumbrance: 3.

**E-Tent:** This shelter is set up for operation in a hazardous environment. It sleeps six human size creatures. An E-tent has a self-contained oxygen supply for 72 hours of continuous operations. This unit utilizes staged cleansing rooms to decontaminate personnel. Encumbrance: 4.

**Filter Mask:** A filter designed to keep dust and dirt out of the lungs, also provides minimal protection against gasses. Encumbrance: 2.

**Geiger Counter:** Used to detect the presence of radiation at up to 8km. Encumbrance: 2.

**Gloves (protective):** These common items are used to protect the hands of someone who is handling dangerous materials. Encumbrance: 1.

**GM-4 Gas Mask:** Matched to the CS-4.

**GM-7 Gas Mask:** An improved version of its predecessor, the GM-4. Filter Sensitivity: 100 microns. Encumbrance: 4.

**Hot Bath:** Set up behind the lines. It is designed to decontaminate personnel as well as vehicles. The hot bath comes with a high pressure hose for vehicle cleaning (Rubber duckies are optional). Encumbrance: 10,000.

**I.D. Tape:** Used to determine the presence of an agent. A strip of the tape is placed on the surface of the object and the tape turns a specific color if an agent is present: red for radioactive, blue for biological, and green for chemical. Each lead foil lined package comes with 20 strips.

## COMMUNICATIONS EQUIPMENT

Characters must carry equipment to communicate between themselves. The range and quality of a communications device is denoted by its transmission level. The level equals the percentage chance to successfully transmit and receive messages under ideal conditions. Certain events affect the ability of certain devices to transmit, such as atmospheric ionization, object obstruction, and jamming. These circumstances reduce the quality of transmission by a specific percentage.

**Example:** Fred is out in the wilderness and attempts to contact with base station Zebra. He is carrying a field pack radio and has 1 level of hand radio skill. There is ionization in the air rated at 58%. The probability of successfully transmitting equals the transmission level minus the relative percentage of ionization;  $115 + 4 - 58 = 61\%$ .

Many communication devices contain scramblers. A scrambler encrypts a message so that it can not be understood by persons scanning the broadcast frequency. "Friendlies" who possess the scramble code may always decrypt the incoming message. The percentage chance to decrypt a message without the code equals the person's proficiency in cryptography minus the scramble level of the transmission.

**Example:** Fredd's message is picked up by Henry the Mutzachan. Decoding the transmission is considered to be a level 4 difficulty. Henry has 4 levels of cryptography. Therefore his chance to decode the transmission equals  $90 - 40 = 50\%$ .

**Ear Transceiver:** A small unit that fits into a human sized ear. It broadcasts and receives radio transmissions. Vocal transmissions are passed along the bones of the skull that connect the mouth and the ear and transmitted out into space. Range: 8km. Transmission level: 100%.

**Radio (hand):** Twenty channels with a range of 16km. The hand radio has a fair transmission level, rated at 100%. Encumbrance: 2.

**Radio (traveler):** This is a hand held unit. It has thirty-five channels and a 27km range. Transmission level 105%. Encumbrance: 2.

**Radio (field):** A backpack unit, used primarily by combat troops in the battle zone. The whip antenna extends to a height of 0.5m. This unit has fifty channels. Scrambler level: 65%, jamming level: 60%, transmission level 115%. Range: 80km. Encumbrance: 20.

**Radio (base):** This unit is mounted onto some fixed object, usually a table. Its high resolution electronic circuitry produces clear transmissions. A base station's jamming ability is rated at 30%. It has one hundred and sixty channels. The scrambler is rated at 40%, range 160km, transmission level 130%. Encumbrance: 100.

**Radio (long range):** This unit is generally mounted. It has a jamming level rated at 70%. The long range radio has simultaneous signal monitoring capabilities. The scrambler is rated at 60%. It has one hundred channels, a range of 1040km, and a transmission level of 130%. Encumbrance: 140.

**Radio (interplanetary):** Used to communicate between different planets within a solar system. It is a common feature found on small pleasure craft and star freighters. An interplanetary radio has multiple signal monitoring capabilities. The frequency is adjustable and the jamming level is rated at 105%. The interplanetary radio has a range of 3.2Bkm and the transmission level is rated at 145%. Encumbrance: 900.

**Radio (interstellar com-link):** Used exclusively on starships. Adjustable frequency. Scrambler level: 120%, transmission level 220%, jamming level 170%. Range: 20 parsecs.

**Shoe Phone:** Once a gimmick, now a reality. The heel is removed to reveal the dialing mechanism. The person speaks into the shoe. Range: 16km, transmission level: 100%.

**Watch Phone:** A single transmitter/receiver unit. Voice activated dialing. Range: 24km, transmission level: 103%.



# COMBAT

Combat in the Battlelords of the 23rd Century universe is vicious and deadly. Weapons systems can easily dish out enough damage to splatter a person from one end of Kingdom to the other end of Come in fractions of a second. Modern combat employs a variety of weapons. The majority are discharge weapons that fire rounds. Still, archaic hand combat retains its merits and is popular among certain cultures. The following section is dedicated to combat and how it works on the hyper-violent battlefields of tomorrow.

## THE DRAW

Any weapon that isn't in someone's hand at the time that combat occurs is considered to be either in its scabbard or holster. In any case, it isn't drawn. It takes 1-4 seconds to draw a weapon. The Eridani can draw any weapon in 1 second.

## INITIATIVE

In discharge combat initiative determines who gets to shoot who first. Roll a d10 and add in modifiers for agility. The lowest aggregate roll acts first. If there is a tie, the persons act simultaneously. Initiative should be rolled on an individual basis. However, in large combat situations it may be grouped for speed and ease of play. Wounded personnel have a +2 added to their dice rolls and critically wounded personnel have a +5 added to initiative rolls. Chatilians gain a -2 to initiative rolls when the enemy is within 2m.

## ESTABLISHING GOOD AIM

Only John Wayne could hit a target at 150 meters, without taking time to aim. Give me a break!!! Aiming takes time and proper aiming implies semi-automatic weapons fire only. No one can really aim on automatic. To ensure hitting a target, you must sight the target, take aim, relax, then "squeeze off the round". The time it takes to aim depends primarily on the distance the person is from the target. A person must spend 3 seconds aiming, plus 1 second per additional 50m of distance. It takes 3 seconds to establish good aim on a target less than 50m away, 4 seconds to engage one between 50-100m, 5 seconds at 100-150m, 6 seconds at 150-200m, etc. Obstructions reduce the chance to hit and increase the time required to aim.

All lasers and arachic powder weapons that utilize scopes require three times the normal time required to take proper aim. This relates the relative difficulty in focusing on the target with a scope. Scoped weapons can never focus on a target that is moving faster than speed 10, (tanks are an exception). Scoped weapons that focus on targets moving between speed 5-10, incur a -20 penalty to their attack number. Aiming at targets moving slower than speed 5 incurs no penalty whatsoever.

## RATE OF FIRE

There are 3 fire segments in a combat round. Each segment equals 1 second. Therefore, each combat round equals 3 seconds. The number of rounds that a weapon can fire in a single second equals its Rate of Fire. There are three modes of fire, semi-automatic, burst, and automatic. Semi-automatic mode fires one shot per second, incurring no penalty to hit. Burst fire mode discharges your weapon's Rate of Fire (if it is more than 1) in one second. However, in Burst fire mode the firer pauses between bursts for at least one second. Any time a firer fires multiple shots per second in two or more consecutive seconds, he is considered to be firing in automatic mode. Burst fire incurs a penalty and automatic fire incurs a major penalty. SEE AUTOMATIC FIRE SECTION. Some weapons are only capable of firing once every few seconds; these weapons do not incur any penalty to hit (they are firing in a slower version of semi-automatic mode). The rate of fire for all weapons is expressed in seconds. SEE the weapons chart for details.

**NOTE!** The effects of combat are determined every second!

**NOTE!** All weapons that have a ROF of 1 can only fire in semi-automatic mode.

**NOTE!** Machine Guns and Machine Gun Lasers fire more than one shot with each pull of the trigger. They always fire in burst or automatic mode; however these systems never incur penalties for these modes of fire.

**Example:** A Mentar-A3L pulse cannon has a ROF of 4. It could be fired in semi-automatic mode, discharging one shot per second. Each burst from this weapon would consist of four shots. If a firer paused for at least one second between bursts he would incur a -25 penalty to hit with each burst. If he did not pause between bursts, his second burst and all consecutive bursts would be considered automatic fire until he stopped firing for at least a second. Automatic fire with this weapon would incur a -50 penalty.

**Example:** A Colt Anaconda has a ROF of 1. It can only be fired in semi-automatic mode, firing one shot per second if the firer so desires. No penalty is incurred.

## DETERMINING A HIT

A weapon has a percentage chance to hit the target at a given range bracket. Add in the operator's skill level multiplied by four, his manual dexterity attack bonus, and the size class modifier for the target to obtain the unadjusted percentage chance to hit. Then subtract the fire penalties for cover and concealment, burst mode, bracing shot, etc.

((Weapons attack number) + (skill level x 4) + manual dexterity attack bonus) + size class modifier)) - (firing penalties) = percentage chance to hit.

**Example:** An M-20 Blaster pulse cannon has a 20% chance to hit a target at range bracket 3 (16-25m). Our man Henry the Mutzachan has 5 levels of pulse cannon skill and a manual dexterity attack bonus of +02 (81 manual dexterity score). He is aiming at Fredd the Python who intends to dismember poor Henry. Fredd is size class 8. The M-20 can only fire on semi-automatic mode (no penalty). Finally, it is dark. The total chance to hit Fredd equals:

((M-20 accuracy) + (Henry's skill level multiplied by four) + (manual dexterity attack bonus) + (size class modifier)) - (darkness penalty)

((20 + 20 + 2 + 20) - (20) = 42% chance to hit.

## HOW MANY SHOTS HIT

Once it has been determined that you hit whatever the hell you were aiming at, you must figure out how many bullets actually raked your target! If you fired in semi-automatic mode, then only one bullet could have possibly hit the target. (Unless of course your name is Don Stefanie and you are always whining that more bullets should have struck the target!)

Burst and automatic fire modes entail firing more than one round per second which is based on the weapon's Rate of Fire. Only one dice roll is made to determine how many bullets hit the target. You roll a die equal to the weapon's rate of fire. The result equals the amount of bullets that hit. If there are other targets in close proximity (2m) to your priority target then the percentage chance that they might be struck by one of your stray bullets equals 20% at 01m and 10% at 02m distance. Of course this only applies if some of your bullets miss.

**Example:** A Thompson sub-machine gun fires four rounds per second. A d4 would be rolled to determine how many bullets hit the target.

**Example:** A M-60 machine gun fires 7 rounds per second. A d8 is rolled to determine how many bullets hit. Reroll all results of 8.

## HIT LOCATION

When firing at a humanoid it is usually convenient to know where you hit. The critical hit table on the Quick Combat Reference Table can be used to determine the location of a hit. For purposes of armor locations the following rolls correspond to these sections:

ROLL	LOCATION
01-18:	Left Leg
19-36:	Right Leg
37-54:	Abdomen
55-72:	Chest
73-81:	Left Arm
82-90:	Right Arm
91-100:	Head

## AUTOMATIC FIRE

There are two types of automatic and burst fire, spread and confined. Confined fire is the discharging of a weapon at one specific target during a discharge segment. Spread fire engages more than one target in a single second by spraying the area. Beam and Energy weapons incur no automatic or burst penalties because they have no kick.

### SPREAD FIRE

Spread fire is attempting to engage more than one target in a single fire segment. The weapon is fired through an arc in a sweeping motion. While sweeping the target area, some rounds strike nothing and are lost. For every meter between targets, one round is ignored when determining the number that actually hit the target. Divide the remaining bullets as equally as possible between the targets, with excess bullets going to the first target.

Spread fire works great when you are being overrun. It is not recommended that you fire in this mode if the target is wearing body armor. Why? Because you generally need to mete out a lot of damage to most armored targets at one time. Spread fire won't provide the damage yield required to take out these targets. Spread fire should be used if and only if there is a reasonable probability of taking out the targets with the damage yield during one discharge segment. Always confine your spread to less than 5m. All targets after the first incur the -40 snap shot penalty. **Exception:** There is only a -20 penalty to hit on the second target if it is within 2m of the primary target.

**NOTE!** When using spread fire there are no penalties for burst or automatic fire, as this type of fire can only be used in these modes.

**Example:** A Gen-Human (Manual Dexterity of 52) is firing an M-60 machine gun at two different Python Lizards (size class 8) who are 30m away (range bracket 4). The lizards are 2m apart. Consequently, two of the bullets are fired in between the lizards and are lost. The M-60 fires seven rounds a second. Only five are rolled for attack purposes. The second target incurs a -20 penalty to hit. The Gen-Human has 6 levels of Archaic Powder Gunnery skill. His chance to hit the first target is  $40$  (M-60 accuracy) +  $24$  (6 levels of skill) +  $20$  (size class 8 target) =  $84\%$  chance to hit. His chance to hit the second target is  $84 - 20 = 64\%$  chance to hit. He rolls and hits both targets. A d3 is rolled to determine how many bullets strike the first target. A d2 is rolled to determine how many bullets strike the second target.

### CONFINED FIRE

Confined automatic weapons fire is firing bursts of more than one shot at one target during consecutive discharge segments. All the rounds fired are aimed at one target. If the roll indicates a hit, then roll the number of rounds that actually hit the target. If the roll to hit indicates a miss, then it is assumed that all bullets have missed. In the first second of automatic fire, only the burst fire penalty is applied. The

following second incurs the full automatic fire penalty. You get a +5 bonus per second of continued automatic fire, while still incurring the full penalty, up to a bonus equal to the automatic fire penalty for the particular type of weapon. It is assumed that you are "walking the bullets in toward the target." Burst fire penalties are half of the automatic fire penalties. However, burst fire does not receive the "walking in" bonus. Any time that you cease firing for at least a second, all "walking in" bonuses are lost.

Archaic powder weapons incur a -40 penalty for automatic fire.  
Pulse cannons suffer a -50 penalty on automatic.  
Omega cannons suffer a -60 penalty on automatic.  
All other heavy weapons suffer a -60 penalty.

The marksman may change targets only at the beginning of a new combat segment and he is subject to the constraints governing the change of targets. If he does not stop firing for at least one second he will incur the full automatic fire penalty and then may begin gaining the "walking in" bonuses as above.

The reason behind firing on full auto and confining your fire to one target is that you can spray the target with multiple rounds in a three second fire sequence. If you own a LTX-311 or some other fast cycling weapon, then you can fire 36 rounds at one target in 3 seconds! Confined fire allows you to take out a target quickly. It is best applied when your weapon does enough damage per discharge segment to penetrate the armor and the target is assumed to have lots of absorption rating. Confined fire has the highest kill ratio of all the types of engagement fire.

**Example:** Phil the Phentari is firing his BC-Destroyer at Ed the Eridani. Phil has a Manual Dexterity of 95 giving him a +4 Attack bonus. He also has 3 levels of Pulse skill giving him a +12 to hit. Ed is size class 6 (+10 to hit). Phil opens up on full automatic, firing 3 shots per second at poor Ed, who is 22m away (range bracket 3). His chance to hit on the first second is  $40 + 4 + 12 + 10 - 25$  (burst fire penalty) =  $41\%$  chance to hit. On the following second his chance to hit is  $40 + 4 + 12 + 10 - 50$  (automatic fire penalty) =  $16\%$  chance to hit. For each additional second that Phil continues to fire at Ed he will gain a +5 bonus to hit. After 10 more seconds of fire Phil will have reached his maximum chance to hit of  $40 + 4 + 12 + 10 - 50 + 50$  ("walking in" bonus for 10 rounds) =  $66\%$  chance to hit. Of course Ed might want to move.

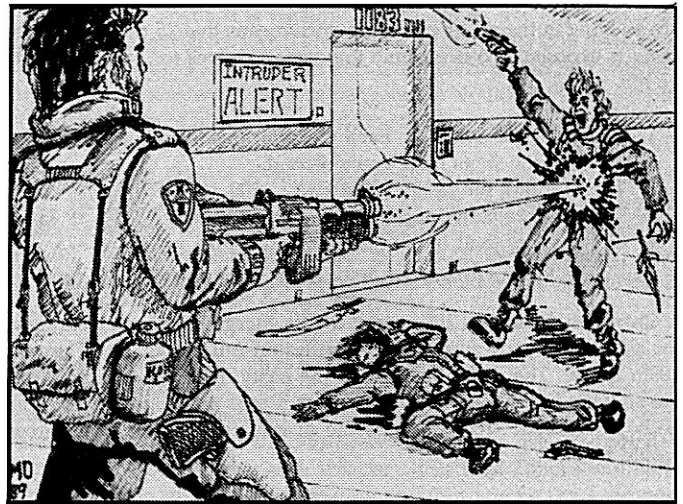

## SNAP SHOTS

Much of the time characters only get a quick glimpse of a target before they shoot at it. This type of targeting is called a Snap Shot. Snap Shots incur a -40 penalty to attack rolls. There is no Snap Shot penalty at 2m or less.



## MASS INCOMING FIRE

What is done when a platoon of enemy troops run at the party, all firing their weapons on automatic! It would take forever to roll each hit for each weapon fired, putting the players into a cataleptic state of boredom. The way to deal with this is simple. Determine how many total shots are fired. If the enemy is firing single shot then the total shots fired equals the number of personnel who are firing. Auto fire is just this number multiplied by the rate of fire. The total chance that each party member is struck is determined as follows:

1. The base chance to be hit equals 1% per shot fired.
2. Divide the resulting number above by the distance divisor.
 

01-25m	= 1
26-50m	= 2
51-100m	= 4
101-250m	= 16
251+	= 64
3. Divide the distance between party members by 5m. Round down. Divide the chance by 2 times this number.
4. Multiply the result by the percentage of body exposed. The result obtained relates the percentage chance that each person is hit. It takes about 2 minutes to figure this out as compared to two hours.
5. Minimum chance to hit is 1%.

**Example:** There are 100 enemy troops charging across a clearing directly to the front of the party. These troops are firing M-16A3 rifles on full automatic. They are 50m away. The distance between the party members is 10m. They are all lying in the prone position which means that 25 percent of their body is exposed. To determine the overall chance that each person would be hit:

1. There are 100 soldiers. Each weapon fires 3 shots per second.  
 $100 \times 3 = 300$  shots fired every second.
2. The charging forces are 50m away.  $300 / 2 = 150$ .
3. The distance between party members is 10m.  $150 / 4 = 37.5$ .
4. Only 25% of their body is exposed.  $37.5 \times .25 = 9.75$ . Round up to 10%. There is a 10% chance per second that each party member will get hit.

**Example:** There are 100 enemy troops charging across a clearing at the party. They are firing M-16A3 rifles on full automatic. They are 100m away. The distance between the party members is 10m. They are all lying in the prone position which means that 25 percent of their body is exposed. To determine the overall chance for each person to be hit:

1. There are 100 soldiers. Each weapon fires 3 shots per second.  
 $100 \times 3 = 300$  shots fired every second.
2. The charging forces are 100m away.  $300 / 4 = 75$ .
3. The distance between party members is 10m.  $75 / 4 = 19.75$ .
4. Only 25% of their bodies are exposed.  $19.75 \times 0.25 = 4.875$ .
5. Round up to 5%.

**Example:** There are 200 enemy troops charging across a clearing at the party. They are firing M-16A3 rifles on full automatic. They are 105m away. The distance between the party members is 15m. They are all lying in the prone position which means that 25 percent of their body is exposed. To determine the overall chance that each person would be hit:

1. There are 200 soldiers. Each weapon fires 3 shots per second.  
 $200 \times 3 = 600$  shots fired every second.
2. The charging forces are 105m away.  $600 / 16 = 37.5$ .
3. The distance between party members is 15m.  $37.5 / 6 = 6.25$ .
4. 25% of their body is exposed.  $6.25 \times .25 = 1.56$ . Round to 02%.

## CALLED SHOTS

At times characters may wish to call out a specific shot location when engaging a target. All normal attacks are considered to be aimed at the mid-section of the opponent. Any attack that is aimed at a specific location other than the torso, is considered a "called shot". The penalty for a called shot varies from -10 to -90. The Battle Master will determine the appropriate penalty. See Quick Combat Reference Table.

## SUPPRESSION

Suppression fire is designed to prevent enemy movement or return fire while friendly troops advance on enemy positions, rescue wounded comrades, retrieve important supplies, etc. When laying down suppression fire, "friendlies" concentrate their fire to blanket an enemy occupied area. The enemy is immobilized and can not return fire and must remain under cover. Any enemy that attempts to return fire while suppressed is subject to being hit. Forces inside bunkers or other fortified positions are not subject to the rules governing suppression fire.

A condition of suppressive fire exists when:

1. Initiative is determined.
2. The winner calls, "laying down suppression fire".
3. Those who lose initiative are automatically put on the defensive. They may not attack without placing themselves in jeopardy.
4. Units or individuals who attempt to return fire may return fire only after ALL friendly forces have made attack rolls. Friendly forces gain +20% on attack rolls against those who try to return fire as opposed to the usual -40% snapshot penalty. Like spread fire, this expends large amounts of ammunition.

**NOTE!** The number of "friendlies" that can fire on a target depends entirely on the situation and will be determined by the Battle Master.

**NOTE!** A character tells the Battle Master how long he intends to lay down suppression fire. The amount of ammunition used up is immediately subtracted from the character sheet. Suppression fire will then continue until the character stops, runs out of ammo, or is incapacitated. He may aim his suppression fire at enemies attempting to return fire but at a -40 snap shot penalty.

## CHANGING TARGETS

Those who are firing on a given target during a discharge segment, then switch to another target at the end of the segment, can not normally fire their weapon during the next discharge segment. **Exception: Characters may change targets and fire on the next combat segment if and only if they fire with a snapshot penalty, and a +3 initiative penalty.**

## RELOADING

Reloading weapons takes from 3-12 seconds for all weapons that use magazines or clips and 5-20 seconds for energy packs. This is due to the fact that energy transfer coils have to be uncoupled and the new pack hooked up.

## MALFUNCTIONS

All weapons, with the exception of most archaic hand weapons, occasionally malfunction. When a weapon malfunctions, it can not be used again until the problem has been corrected. Sometimes the weapon actually breaks and must be repaired. Repairs can be made on the spot if the appropriate tools are available. Otherwise, the weapon must be taken into a repair shop for maintenance. Pulse, Omega, and all beam weapons overheat when they malfunction. Archaic powder weapons jam. SEE MALFUNCTIONS ON PAGE 222.

## COMBAT MOVEMENT

Combat movement is different than normal movement. Normal movement implies walking erect. It requires little energy and can be sustained for long periods of time. Most combat movement cannot, but does reduce enemy sighting attempts and attack rolls. Given below are some common types of combat movement and their effects.

**Crouched Run:** The individual is bent forward at the waist, running in a hunched over position. He runs at 1/2 his normal speed and can sustain this mode for no more than 1/2 his Constitution in seconds. The character must rest for 1 minute before continuing. All enemy sighting and attack rolls are reduced by 15%. The soldier can fire his weapon while in this mode, although he incurs a -15% penalty on top of a standard snap shot penalty, for a total of -55% to attack rolls.

**High Crawl:** The combatant lies on the ground, hands tucked under the chin. He moves by shuffling forward on his belly, using his knees and elbows to propel himself along. This technique can't be performed with Pulse, Omega, Meson, or any other heavy weapon that utilizes an inertial-grav system. One can sustain a crawl type of movement for his Constitution in seconds, without resting. The soldier can crawl 15m in one minute. Fatigued characters must rest for a minimum of 30 seconds before proceeding. Sighting and attack rolls against a person high crawling incur a -25% penalty.

**Low Crawl:** The most difficult of combat maneuvers. The soldier lies on his belly with his head turned to one side and holds his weapon by the sling. He then pulls himself along the ground by his hands. Again, Pulse, Omega, and all other heavy weapons can't be carried when using this type of combat movement. The soldier can crawl 10m in one minute and can sustain this type of movement for up 1/2 of his Constitution before requiring rest. Detection and attack rolls against low crawling soldiers incur a -35% penalty.

**Crawl:** This is the easiest type of crawl. You sling your weapon on your back and crawl on your hands and knees. The soldier may crawl 25m per minute. This crawl can be sustained for a characters constitution multiplied by two in seconds. The sighting and attack rolls of enemies are at a minus 20% penalty.

**Evasion:** At the beginning of any new discharge segment, a soldier can attempt to evade combat. He must have initiative. The character then attempts to withdraw by making a purely defensive maneuver such as running off into a thicket or diving behind cover. Most attempts to evade combat leave the evader very susceptible to attack. The attacker has a +15 modifier to attack rolls against targets using evasion.

## COVER AND CONCEALMENT

When view of a target is obstructed it is concealed. If a solid obstruction such as a wall is in the way, then the target is considered to be covered. The percentage reduction to hit due to cover and concealment ranges from -10 to -50, depending on the circumstances. See Quick Combat Reference Table.

Certain heavy weapons will go right through walls and other forms of cover. In these cases assume concealment, but reduce damage done as it penetrates the barrier. It is also possible to take called shots at people under cover (aiming for exposed areas) which is a more accurate way of hitting, yet it requires extra time.

## CRITICAL HITS

Body points represent the body's ability to take damage. Any time a person suffers damage equal to 25% or more of his body points, then the person is assumed to have suffered a critical hit. The person must immediately make a system shock roll to remain conscious. There is an optional chart that details the effects of critical damage. This is covered in more detail in the Battle Master's section in the rear of the book.

The accumulation of damage to an area causes a critical if the total amount of damage done exceeds the amount necessary for a critical wound. If an already critically wounded section of the body takes another hit, it automatically constitutes a critical hit.

## ARCHAIC HAND WEAPON COMBAT

Archaic Hand Weapons combat functions under the same rules as normal combat. Initiative is determined, then combatants make their attacks. The attack number is determined in the same manner as with all other combat rolls. There are, however, some major differences between archaic hand weapons combat and weapons discharge combat. Most stem from the fact that individuals engaged in hand to hand combat have more options open to them than those involved in weapons discharge combat. The following gives the different options for attacking. An archaic weapon combat round is 3 seconds long. Like discharge combat, it is broken down into 1 second segments. Actions occur each second.

**Number of Attacks:** The number of attacks a person is allowed with archaic hand weapons is normally equal to the Rate of Fire of the weapon. For example, a person would normally get one attack per 3 seconds with a long sword. Persons gain one additional attack per 3 seconds, or the amount of time it normally takes to swing the weapon once, whichever is longer, for every 3 levels of archaic hand weapons skill. Eridani receive one extra attack per three seconds due to their natural weapons skill. A person who uses a weapon in each hand receives an additional attack or parry with the second weapon based on its rate of fire. Due to the difficulty of wielding 2 weapons, the weapon in the primary hand functions at a -10% penalty and his secondary weapon is at -25% (on top of all other penalties). When using two weapons which fall under the same skill, additional attacks are split between the weapons. People who go berserk double their normal archaic or hand to hand attacks each round.

Phentari are entitled to use 2 weapons, without incurring a penalty to hit. The 3rd and 4th tentacles can be employed in an attack, with a minus 25% penalty. Furthermore, Phentari can target two separate enemies at the same time.

**Example:** A Human is wielding a two handed sword. He has 3 levels of skill. He is entitled to make 2 attacks per four seconds (Base ROF + one attack). He attacks every other round.

**Example:** A Phentari is wielding two daggers. He has 9 levels of skill. Each dagger gives him 2 attacks per second. His skill gives him 3 extra attacks per 3 seconds. He gets five attacks per second with his daggers. If he was wielding four daggers, he would get 9 attacks per second, but four of his attacks would be at -25.

**Example:** An Eridani is wielding a Long Sword. He has 6 levels of skill. He gets 1 attack per 3 seconds for the weapon. He gets 2 additional attacks for his skill, and 1 additional attack for being an Eridani. His total number of attacks is 4 attacks per 3 seconds. The same Eridani, with 24 levels of sword skill would get 10 attacks per 3 seconds.

**Example:** A Ram Python is wielding a Broad Sword in his primary hand, and a Short Sword in his secondary hand. He has 6 levels of sword skill. He gets 1 attack per 2 seconds from the Broad Sword, and 1 attack per second from the Short Sword. He also gets 1 additional attack per 3 seconds with each weapon. His total attacks will be 2 every 3 seconds with the Broad Sword, and four attacks per 3 seconds with the Short Sword. The Broad Sword will be at -10 to hit. The Short Sword will be at -25. If he was berserk he would receive 4 per 3 second with the Broad Sword and 8 per 3 seconds with the Short Sword. He would also receive a +15 to his attacks when berserk.

**Initiative:** Each round the combatants must roll initiative to see who can attack or defend themselves. The winner can choose to attack, feint, or give up the initiative (how sporting). The looser may then defend himself. Each attack, parry, or feint takes one action.

Chatilians are difficult to surprise and gain a -2 to initiative if they are concentrating on an opponent who is less than 2m away. They can read their opponent's mind and thus know what is coming up. This ability is nullified if the person has mental protection.

There is only a 10% chance to surprise Phentari from behind and squids make normal initiative checks when attacked in this manner.

Cizeracks who win initiative can jump over their opponents heads. If they make an agility check at a -70, then they gain a -4 to initiative in the following round.

**Attacking:** When an attacker wishes to do damage to his opponent, he merely rolls versus his chance to hit (determined by skill, agility, and the accuracy of the weapon used). This is modified by situation and terrain. If he rolls under the resulting number, he hits. The defender may parry an attack but must declare it before the roll is made.

**Parry Negation Modifier:** Parrying is an attempt to deflect an attack with one's weapon. The defender totals up his chance to parry and subtracts it from the attacker's Unadjusted to hit number. The result is the modified chance to hit. A successful parry deflects the blow and lends the defender a -2 to initiative rolls during the following hand to hand segment.

**Unadjusted Attack Number - Parry Negation Modifier = Adjusted Attack Number**

((Weapon attack number) + (skill level x 4) + agility modifier) + situation modifiers)) - ((weapon parry number) + (skill level x 4) + agility modifier) = Adjusted Attack Number.

Phentari who use more than one tentacle to parry, reduce the opponent's chance to hit by 06% per additional tentacle employed.

**Example:** Phil the Phentari is attacking Ed the Eridani. Ed has 5 levels of archaic hand weapons (sword) skill (+20 to parry rolls). He is wielding a long sword (parry number equals 35). His agility modifier is +10. His total parry chance equals: 20 + 35 + 10 = 65. Phil has 3 levels of archaic hand weapon skill (+12 to attack rolls) is wielding a two-handed sword (attack number of 85) and has an agility modifier of +4. His total "to hit" chance equals: 12 + 85 + 4 = 101. Phil's chance to strike Ed is reduced by the Parry Negation Modifier or 101 - 65 = 36%. Phil has a 36% chance to hit Ed.

**Feint:** To feint is to fake an attack in hopes of gaining an advantage by distracting your opponent during close quarters combat. The chance to make a successful feint is similar to parrying. Intuition plays an important part in a feint, relying on the person's ability to force his opponent's next move, then take advantage of it. A successful feint gives you a -2 initiative bonus the next round, and subtracts 20% from the opponents chance to parry your next attack. A failure to feint gives you a +4 to your initiative the following round, and subtracts 10% from your chance to parry your opponents next attack. Hence, feints are determined as follows:

**(Defender's Intuition - Attacker's Intuition) + (Defender's skill modifier - Attacker's skill modifier) + (Defender's agility modifier - Attacker's agility modifier).**

**Example:** Ed the Eridani is making a feint at Phil the Phentari. Ed has 5 levels of archaic hand weapons skill (+20) and an intuition of 90. His agility modifier is +10. Phil has 3 levels of archaic hand weapons skill (+12 to parry rolls) and an agility modifier of 4. His intuition is 50. Ed's chance to successfully feint equals:

$$(90 - 50) + (20 - 12) + (10 - 4) = (40 + 8 + 6) = 54\%$$

## HAND TO HAND COMBAT

At times characters are forced to engage in hand to hand or unarmed combat. Hand to hand encompasses punching, kicking, and grappling. The base chance to strike someone is 50%, modified by skill and agility scores. Most other related tasks are treated exactly the same as with Archaic Hand Combat.

**Temporary Damage:** All damage done in hand to hand combat is considered to be temporary. Temporary Damage equals 1/10 real damage. Temporary damage heals at a rate of 1 point every 5 minutes. If an individual takes enough damage to reduce his body points below zero, then he has been knocked out. Strength bonuses are applied to all forms of hand to hand combat. Hand to Hand combat works in the same manner as Archaic Hand weapon combat and the two can be mixed. Hand to Hand combat does not incur catastrophic damage unless the attacker does real damage with claws or fangs (SEE damage section in chapter 3).

Certain areas of the body are more sensitive to attacks, such as the genitalia (better known as the package!) The face is another tender spot. Any hit to these areas doing more than 1/2 the targets body points will cause a critical.

**Attacking:** Attacking is treated exactly the same as with Archaic Hand Weapons. However, persons may use feet as well. Attacking with feet incurs a +2 initiative penalty. However, this attack form does double temporary damage.

**Blocking Negation Modifier:** There is a base 25% chance to block an attack. Otherwise, determining a block is exactly the same as parrying. The chance to block an attack equals:

**Unadjusted Attack Number - Blocking Negation Modifier = Adjusted Attack Number**

((50%) + (skill level x 4) + agility modifier) + situation modifiers)) - ((25%) + (skill level x 4) + agility modifier) = Adjusted Attack Number.

**NOTE!** A -20 penalty is applied to blocking kicks.

## GRAPPLING

Often combatants wish to grapple with an opponent, either to damage or subdue him. Grappling occurs most often in bars and areas where weapons aren't readily available. Of course, that first punch knocks you on your butt and you end up holding on for dear life! This section deals with the application of grappling tactics.

**Initiative:** Initiative is rolled as with any other attack. However, any attempt to grapple with someone holding a weapon has some restraints, namely they get to take a shot at you first. The initiative winner rolls to hit. On the subsequent round, he must roll initiative again, but at a -4 to the check. He must do this to insure maintaining control of the defender. If the defender wins somehow, and makes a strength check at a -30, then he has broken free from the attacker's grasp and the entire grapple process must be started all over again. If the defender does not win initiative, then the attacker may attempt a move. He must roll to hit:

((50%) + (skill level x 4) + (agility attack bonus)) - ((defender's skill level x 4) + defender's agility bonus)) = percentage chance to grapple.

**Arm Lock:** Pins the opponent's arm behind his back. The attacker has the option of breaking the arm in the next segment. To break the arm, the attacker must make a strength check at -40 penalty (-90 vs Pythons).

**Leg Lock:** Pins the leg. The attacker can snap the knee on the following segment by making a successful strength check at -80 penalty (-120 against Python races).

**Head Lock:** The attacker has the option to make a successful strength check in order to snap the opponent's neck in the next combat segment. This hold is difficult to achieve. The attacker must make a strength check at a -70 to snap the neck (-140 for Python races). If the defendant doesn't break loose from a head lock, he may lose consciousness. 2d10 are rolled to determine when the point where this may occur. Beyond this point, the defender must make a cumulative constitution check at an additional -10 penalty every 3 seconds or black out.

**Throw:** The attacker must make a strength check at a -20 per size class difference between him and the defender to throw someone. Success indicates that the person has hit the ground. The attacker gains a -5 initiative to all kicking attacks until the person manages to get to his feet which takes 1-4 seconds.

**Trip:** The attacker has the option to trip someone and must make an agility check at a -penalty equal to the difference between his agility and the defender's. Success indicates that defender has been knocked to the ground and suffers the same penalties as with being thrown.

**DEFENDER OPTIONS**

The defender has some options, dependent on the hold he is in. He can make one or multiple attacks, foot and or hand as detailed in the table below:

	Hand	Leg
In Arm Lock:	1 (-20)	2 (-40)
In Leg Lock:	2 (-10)	1 (-60)
In Head Lock:	2 (-50)	2 (-50)

**Foot Stomp:** The defender stomps on the instep which does 1 point of temporary damage.

**Elbow Smash:** The defender is facing with his back to the attacker who holds him usually in a head lock. The defender makes a hand attack at a -40. Success does 1 point of temporary damage to the ribs.

**Head Butt:** The Mutzachan's favorite tactic. The defender attacks at a -20 and must strike the head area to be effective. This attack does 2 points of temporary damage.

**Bite:** A nasty and dishonorable tactic that doesn't work especially well against Python Lizards. The defender must roll to hit a -20 and this attack has a 25% chance to do one point of real damage. Biting someone while in a head lock is done at a -40.

**Tail Swipe:** Only applicable to Python Types. The Python is facing with his back to the attacker. He swipes the feet out. He attacks at a -30. Affected persons must make an agility check at a -80 or be knocked over. They also suffer 1/2 real damage.

The BM may add any other attack type that he sees fit and has final say over grapple combat. These rules are guidelines to follow and should be adjusted on a case by case basis.

**MISCELLANEOUS HAND TO HAND COMBAT INFORMATION**

**Called Shots:** Characters may grapple for specific areas and incur the same called shot penalties as with other types of combat.

**Berserking:** Characters with aggression scores over 80 have a chance to berserk when engaged in any form of combat. For every point of aggression higher than 80, the character has a 01% chance of berserking. Berserkers gain a +15% to attack dice, and +3 to damage when using any close quarter combat weapon or unarmed combat. He attacks at a -15 modifier when using ranged weapons, and suffers -25% to parry attempts. He gains double his normal attacks per hand to

hand segment and fights into the negative hit points. A berserk fighter remains conscious from -1 to -6 body points before collapsing. Roll a d6 to determine the point of collapse.

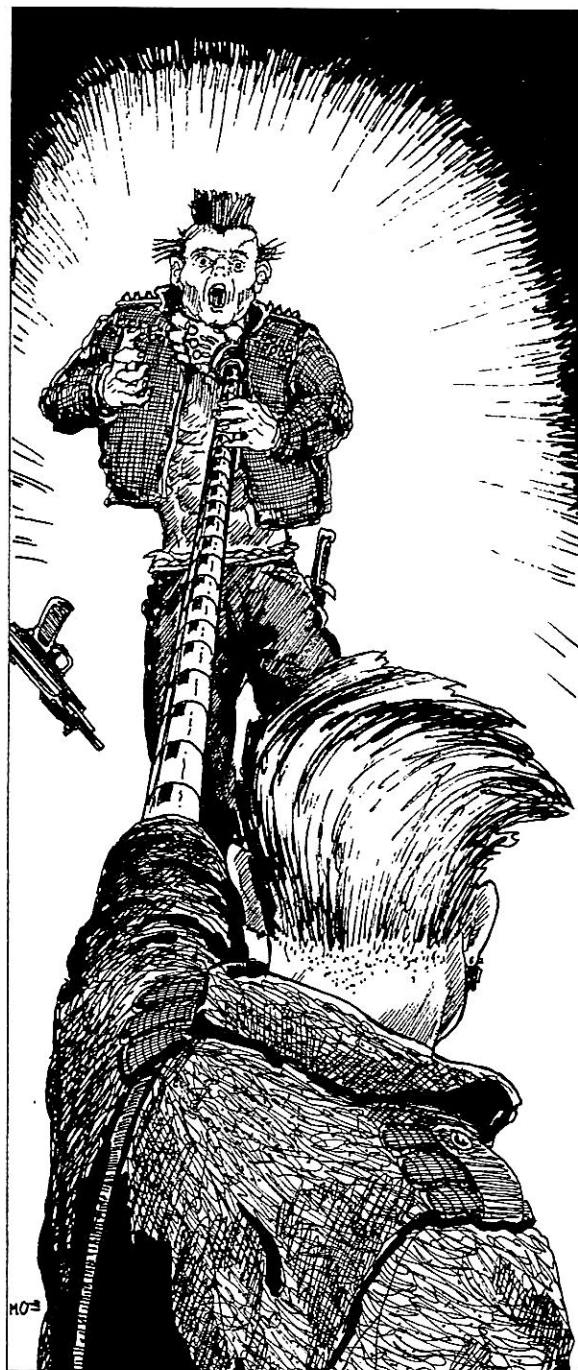

**Suicidal Rage:** Any character with an aggression score of 105 or greater may turn suicidal. Suicidal characters attack without thought of injury or death. The percentage chance to turn suicidal equals 01% per point of aggression above 105. They gain double their normal attacks per round, add +25 to all attack rolls, and add +5 to damage when using archaic hand weapons. They attack at a -30 modifier with any discharge weapon, and will not parry or defend in any way. Suicidal berserkers think of nothing but the destruction of their opponents. Suicidal maniacs fight up to the point where they die. (i.e. they remain conscious till their body points reach their death's door rating and they are dead). Characters either berserk or become suicidal, not both.

## THE SURVIVAL MATRIX ROLL

There are special types of combat not governed by normal weapons discharge or hand to hand combat. Characters subjected to an attack from these forms must roll on the Survival Matrix Table in order to avoid or minimize taking damage. Failure indicates that the special attack has overwhelmed the character and he has taken damage.

**Chemical:** Nerve gas, blister agents, blood agents, etc. The damage varies greatly, depending on the type of agent used. An average damage yield is 3-18 points. One point of constitution is lost per point of damage sustained. Other vital statistics may also be affected, depending on the agent encountered. The effect on constitution for chemical agents is permanent.

**Radiation:** Radiation damage deteriorates body functions. A typical heavy exposure does 2-8 points of damage. Each point of damage reduces constitution by 2 points. Strength is reduced on a point for point basis. The effects are permanent, unless treated with advanced surgical procedures.

**Biological:** Represents the ability of the body to defend itself from the effects of invading viruses and bacteria. Certain biological attacks cause damage to the body. The amount and severity will be determined by the Battle Master.

**Mental:** Attack forms employed by empaths. The effects depend on the type of matrix used.

**Poison:** Another special chemical form. Poisons are ingestive, insinuating, or contact. Victims usually make a successful SMR or die, although some poisons only cause damage. Modifiers are applied to the SMR depending on the strength of the poison.

**Sonic:** Powerful sound or concussive waves damage the body at a varying rate. The damage depends entirely on the severity of the blast. Victims are often stunned and/or deafened.

**Electrical:** The amount of damage sustained depends on the amount of current. A low line shock does 2-8 points of temporary damage, whereas a powerful shock might do 3-12 points of real damage. The damage sustained depends on amperage, not volts.

**Fire:** Fire is one of the most damaging attack forms when dealing with live tissue. Persons can suffer anywhere from mild 1st degree burns (like sunburn) all the way up to 4th degree (where even the bones themselves are charred and destroyed). Damage depends on temperature and duration.

**Acid:** A special chemical attack. Acid burns the body and leaves horrible scars. A typical splash does 1-4 points of body damage. Facial burns reduce charisma by 03% per point of damage received. All effects are permanent.

**Cold:** A lot of people do not realize the effect of severe cold. Severe cold tends to shut the body down. Frostbite often causes loss of fingers, toes, or worse depending on the exposure.

## MATRIX COMBAT

Powers combat functions similar to normal combat, but there are some differences. Powers have a certain generation time and this represents the waiting period that the matrix controller must concentrate in order to "generate". It is expressed in seconds. During this time, the matrix controller must remain still and focus; thus he is vulnerable to attack. Any attack that strikes the MC while he is "generating" voids the power and the energy needed to generate it. Most powers allow an SMR of some type to resist the attack. The SMR allowed for each power is listed with its description. For full details of powers combat and the SMRs for each special powers SEE POWERS.

## COMBAT TACTICS

Players will be faced with a multitude of different combat situations, some simple and some complex. There is no way for someone to prepare for every problem. I believe that certain tactics are more sound than others. I was in the Army for 4 years. I hope I can shed some light about the methodology behind basic combat tactics.

## PATROLS

From time to time players will need to go out on patrols. The typical patrol has 10 individuals. Each man is positioned 5 meters away from the next. This insures that a surprise burst of automatic weapons fire won't get more than 2 or 3 men. The first individual is the point man. He is responsible for locating mines, hidden traps, and spotting enemy units. He normally travels about 8m in front of the squad. Most patrols carry at least 1 heavy weapon, preferably 2. If there is only 1 heavy weapon, it should be positioned with the 7th man out of the ten. Statistically, he has the highest SAS (Surprise Attack Survivability) rating. In the event of an engagement, he must lay down fire on enemy targets. The leader should be positioned directly in front of him. The communications officer stands in the 5th position. The leader can thus communicate to other units and give fire commands to the heavy weapons operator. The first three men have the lowest SAS rating. Therefore, the medic follows them in 4th position. Last in line is the rear guard. His responsibility is to insure that the patrol isn't attacked from behind. The rest of the squad is randomly distributed and usually looks like this:

1. Point man
2. Soldier
3. Heavy Weapons Operator
4. Medic
5. Commo Officer
6. Patrol Leader
7. Heavy Weapons Operator
8. Soldier
9. Soldier
10. Rear Guard

## CAMOUFLAGE

Characters can reduce or completely negate the chance of being visually spotted by camouflaging themselves. The facial outline is broken up by applying camouflage paint. The high areas, those that stick out such as the forehead, cheeks, and jaw, are painted black. The low areas, such as the bones around the eyes and dimples, are painted white. The rest of the face is painted brown or green, depending on the terrain. The body's silhouette must be broken up. Players should attach local grass, twigs, leaves, etc. into the folds of their clothing. It takes about 30 minutes to apply a good camouflage.

Characters will be forced to hide equipment from time to time to avoid its detection. Camouflaging equipment is rather straightforward. First, all shiny or metallic surfaces should be covered with a thin layer of mud to protect against reflection. If the equipment has glass, cover this with some kind of tarp, not mud. The tarp can be removed easily in case of a sudden urgency to move out. Mud can not. Engines should never be left running. They should only be turned on at sunrise and sunset. Last, the contour of the vehicle must be broken up. This is done by setting up poles with butterfly covers in random placement, then covering the vehicle with a camouflage net. A properly set camouflage net breaks up the electronic image of spotters used by aircraft to detect ground machines and equipment.

## GUARD DUTY

Pulling guard duty is a must. Two individuals should be on guard duty at any time. They should never stand within 5 meters of each other, no matter what. They should never use light. Guards walk in opposite directions, crossing at some specific interval. Characters are advised to use hand signals and not speak.

## MILITARY ABBREVIATIONS

- GI:** Galactic Issue. The name given to all individual who join the Galactic Services.
- UCMJ:** The Uniform Code of Military Justice: The governing body of rules for those individuals in the military.
- BRAS:** Breath, Relax, Aim, Shoot. The method for proper aiming.
- AO:** Area of Operations. The specific area in which a unit performs maneuvers.
- CP:** Command Post. Center of operations where commands are issued to different facets of a unit.
- MIA:** Missing in Action. Title given to all soldiers who are presently unaccounted for due to combat.
- KIA:** Killed in Action. The abbreviation for all those soldiers who have died as a result of combat.
- LZ:** Landing Zone. The cleared battle area where airborne vessels land and take off.
- SOG:** Sergeant of the Guard. The ranking soldier in charge of guard duty. The SOG is responsible for the posting of the guard roster and the changing of guard watches.
- DAC:** Data Analysis Computer. Powerful computer used aboard spacecraft to determine various responses to tactical situations.
- TAC:** Target Acquisition Computer. Used to gain electronic lock on to targets.
- OCS:** Operations Control Center. Main control center that issues out orders to the various CPUs.
- OSD:** Orbital Surveillance Device. The name given to all reconnaissance satellites.
- SDS:** Space Dropped Shuttle: All atmospheric re-entry vehicles dropped from a mother ship.
- APC:** Armored Personnel Carrier. Vehicles designed to deliver and remove troops from the battle zone.
- ATW:** Anti-Tank Weapon. Devices designed specifically to destroy armor.
- MLRS:** Multiple Launched Rocket Systems. Vehicles that fire large amounts of missiles simultaneously.

## USE OF HAND RADIOS

Players must learn how to correctly use communication procedures. Their lives will depend on being able to translate communications into understandable terms. The Battle Master will be calling out radio information in a military manner. Correct communications procedures prevent disasters from happening when individuals don't understand each other.

Military units use words when spelling out letters over the radio. During combat, it is often difficult to distinguish from a spoken "d" or a spoken "b". The military alphabet is spoken as:

A=Alpha	G=Golf	M=Mike	S=Sierra	Y=Yankee
B=Bravo	H=Hotel	N=November	T=Tango	Z=Zulu
C=Charlie	I=Indigo	O=Oscar	U=Uniform	
D=Delta	J=Juliet	P=Papa	V=Victor	
E=Echo	K=Kilo	Q=Quebec	W=Whiskey	
F=Foxtrot	L=Lima	R=Romeo	X=X-ray	

**Example:** Fredd wants to spell out Alien over the Radio. Fredd would say "I spell alpha-lima-echo-delta-november". Fredd isn't very bright, now is he.

Military units count in the manner of:

1=One	3=Tree	5=Fife	7=Seven	9=Niner
2=Two	4=Four	6=Six	8=Eight	

## NEVER AND ALWAYS

There are certain things that individuals should always do when in any type of hazardous or combat situation. On the same token, there are just as many things that should never be done. I have compiled a list of the Do's and Don'ts of the futuristic combat soldier.

- Never carry a half filled canteen while on maneuvers or patrol.
- Never get caught sleeping on guard duty.
- Always clean your weapon after combat or exposure to moisture.
- Never walk on trails.
- Always secure your "frags."
- Always cover one eye when a flare is sent up at night.
- Never leave the camp unguarded.
- Always have two men on guard duty at the same time.
- Never salute an officer in the field.
- Never call a sergeant sir, (whether you're in combat or not).
- Always carry an emergency transmitter.
- Never light visible fires at night.
- Always carry the detonator in hand when setting up explosives.
- Always use a staggered formation when moving as a group.
- Never bunch up.
- Never trust a Python who says, "I'm soft and gentle."
- Never spacewalk without a second security line.
- Never talk to that Python who said, "I'm soft and gentle."
- Always clean up and bury all residual garbage in the "field."
- Never "frag" an officer unless you are sure to kill him.
- Always hold your weapon so that the barrel points to the sky.
- Always carry at least 1 BRI.
- Always tuck in pant legs and stray clothing when in the "bush."
- Never trust anybody named Guido Sarducci.
- Never engage the enemy before he is committed.
- Never stand behind a rocket launcher.
- Always wear your A-grav belt when toting heavy weapons.
- Always check the filters of your gas mask for rips and/or tears.
- Never wear any type of rank when in a battle zone.
- Always carry 2 dog tags, so that one can be stamped and put in your mouth and the other can be tied around your big toe when you blow it.
- Never leave dog tags outside your uniform or armor. That's blowing it.

## MAKING GOOD DEFENSIVE POSITIONS

At times, players will be forced to dig in and take defensive positions in order to defend a strategically important location, or simply because they have no other choice. Survival depends on the character's ability to set up such a location fast. The following information gives pertinent information regarding the setting up and use of a good defensive position.

**Selecting the Site:** Select a site with a large clearing, away from trees where enemy troops can hide. If at all possible, locate such a position on top of a hill. This gives a better vantage point by which to observe enemy movement, and it takes longer to charge up a hill. If enemy aircraft are in the area, ignore all of the above. Stay in the foliage and take your chances.

**The Perimeter:** Once a position has been chosen, players should set up perimeter defenses. Perimeter defenses include barbed wire or electrical fences, pits, trip flares, and mines to prevent enemy intrusion. Barbed wire should be set up in two layers completely surrounding the encampment. Outside the barbed wire should be placed the mines and trip flares. Between the 1st and 2nd layer of wire place more flares.

**Bunkers:** A bunker is a fortification set mostly below the surface of the ground. It is fitted with openings which personnel can fire through. A bunker has an overhead protection built of logs, earth or stone to protect from air attack. Bunkers are strategically placed at points where defenses are inherently weak. They should be manned with heavy weapons.

**Trenches:** These are long excavations in the earth with dirt thrown up over the sides to protect individuals from enemy weapons fire. They are used to connect bunkers and foxholes to the Command Post. They should be dug to about chest depth.

**The Foxhole:** A small pit dug into the ground to protect combat troops from enemy fire. Usually built for one or two men. Normally spaced equidistant between bunkers.

**Grenade Sump:** A grenade sump is a downward sloping hole dug into the bottom of a foxhole. It has a small overhanging lip on top. Grenades that land in the foxhole can be kicked down into the sump, saving the character from injury due to the explosion and fragments. It also reduces the effects of concussion damage.

**Limiting Stakes:** Limiting stakes are sticks set into the ground in a V shaped configuration at the front of the foxhole. The soldier places his weapon in the V. The V restricts the firing arc of the weapon. Limiting stakes are set up in each foxhole to provide overlapping fields of fire.

**Range Stakes:** Sticks are set into the ground at varying distances. This is done so that troops can gauge the distance of enemy troops from their respective positions. Range stakes provide a +05 to hit.

**CP:** The Command Post. Central nervous system of any position. Has communication ability with all other sections of the defense. Commander of the troops directs activity from here.

**Commo Phone:** Wire contacted telephones leading from bunkers and foxholes to the CP. Allows individuals to report enemy activities to the Commander.

**Guard Post:** Posts set up at strategic positions where enemy activity can be scrutinized. Usually manned by two or three individuals. Direct commo line to the CP. Heavy weapons.

## MORTALITY

*"The door is barricaded, but you submersed in your folly do not heed its warnings. You come to kill me, as if in dying you might make me less. You revel in your feror, hot for battle. I, in my stoic splendor await you. I savor this, the final test of my being. Might you come in large numbers so more grand might be my epitaph. I must praise your resoluteness. This I must do. For you will come and you will die, a pyre of bodies to glorify my courage. I await you..."*

Note found on the body of galactic fugitive,  
Edimus Phentari

Let's face it. No one lives forever and many a warrior has fallen on the Field of Valor. It happens. Sometimes you just drop in at the wrong place, at the wrong time. It isn't really the end of the world. A character dies when he or she reaches -10 body points. This number is subject to adjustment by constitution modifiers, but normally at -10, you are HISTORY!!! But you just might not be finished yet. There are several different methods by which you can be brought back from the grave to your place among the LIVING!!!

As long as the body hasn't received catastrophic damage, there is some possibility of restoring a dead comrade's health. Catastrophic damage is considered to be three times the death's door value for an individual. A person who normally dies at -10 body points has taken catastrophic damage when he has fallen to -30 body points or below.

**Example:** Fredd the Python gets blasted into little lizard pieces by a Calsham 4 laser cannon. Normally, Fredd dies at -15 body points. Fredd has a constitution of 116. Poor Fredd seems to have taken a little bit more damage than was necessary to kill him. He is currently at -52 body points. If our hero had only been at -45 or less, the wonders of modern medicine could possibly revive him. But there is just not

enough Fredd left. If a character hasn't received catastrophic damage, he can be revived.

An expired person **MUST** receive proper medical attention within minutes of his demise or be cryogenically frozen until such a time that he can receive this aid. The chance of a character being successfully restored is affected by his constitution as well as the damage sustained to his body. The Revival Percentage denotes the basic chance to successfully restore a person. Subtract half the total damage taken from the Revival Percentage to determine what the chances are of bringing someone back to life. Don't quite understand? Well, lets see how they brought back poor Fredd. Fredd had initially sustained too much damage to be restored. Now let's assume that Fredd only took enough damage to put him at -40 body points. He could then be revived. With a constitution of 116, Fredd's Revival Percentage is an incredible 85%. In top physical condition, Fredd has 30 body points. The Calsham 4 laser did a total of 70 points of damage to him and brought him to his current condition of -40 body points. So we subtract half the total damage done to Fredd (70 points) from his Revival Percentage (85%). There is a  $85 - 35 = 50\%$  chance to revive Fredd.

There is one other remote possibility, gaining the assistance of a powerful Chatilian Empath and a Zen Rigel'n Healer at the same time. Good luck!!! The typical medical cost to have someone revived is 250,000cr, give or take 10cr. Most players are not able to afford this. Don't fret. The sponsor corporation typically covers the bill, extending your contract five to ten more years to cover costs and expenses, assuming that you are worth an investment of such proportion.

Warriors on the futuristic battlefields can be placed into deep freeze if they are given a Cryo-injection. Casualties are also stored in freeze chambers until proper medical treatment is secured in the "rear". The Body Cart is a portable chamber, complete with built in inertial-grav system for easy transportation of wounded or expired personnel.

## SUPER-HEALING (Bless the BRI)

The BRI has some wonderful uses that haven't been covered yet. You can use BRIs to jump start someone's heart. Now when you get "offed" from a critical hit, your body is assumed to be at 1 point below your Death's Door. If you took catastrophic damage then there is no way to jump start your corpse. There is a 05% chance per Massive BRI used (5 maximum) that your body can be temporarily revived, if someone gets to you within 5 minutes. If the party fails to bring you back initially, they can try once more. However, it requires twice the amount of MBRI's to obtain the same effect (10 maximum). To gain a 15% chance of jump starting someone a second time the party would require 6 MBRI's. The presence of someone with paramedic skill can be very useful. There is an additional 02% chance to bring a person back, per level of paramedic skill that the medic-technician has.

Only MBRI's can be used to bring a body back from the dead. Persons automatically lose 10 points of constitution if they are brought back from the dead. If the party is successful in bringing a comrade back, there is a 10% chance per MBRI used that he will be addicted to the drug. Those persons who are addicted to the drug will require no less than 2 MBRI's per day. They will suffer withdraw without the drug. Withdraw includes cold chills, fever, thirst, muscle spasms, vomiting, etc. Furthermore, addicts burn their body out, losing 1 point of Constitution permanently per day while addicted. **AGAIN, ANY CHARACTER ADDICTED TO BRI's LOSES 1 POINT OF CONSTITUTION PERMANENTLY PER DAY!!!** The only way to purge the system is to put the character in drug rehab for 1-4 weeks, and there is still a 02% chance that the character will die while isolated. The cost for drug re-hab is 4000-8000cr per week and re-hab centers are only found on Tech Level 3 or higher worlds.

A person loses his Constitution and Strength at a rate proportional to how many body point are lost. He regains them at a rate directly proportional to the amount of points that he lost, compared to the amount of points that he started out with.

**Example:** Henry the Mutzachan lost 2 body points. He started with 5 body points. He has a compound fracture of the left leg which heals at 1 point every 10 days. Well 40% of his body points have been lost. So his Constitution is dropped to 60% of the norm. He gains back 1 point every 10 days or 20% of his total Constitution every 10 days. Therefore, his body recovers Strength and Constitution at 02% per day.

No matter how much you get back from BRIs or MBRIs in a couple of minutes, your Constitution and Strength are restored at a rate 10 times the normal healing rate (SEE Battle Master's section). This assumes that you never went into the negative body points.

**Example:** Henry has the same wound, but is injected with a BRI that heals him completely in a few minutes. He only gains back his Constitution at 20% per day and won't be completely fit for duty for 2 days.

Anytime that your body enters the negative body points, problems arise. Yes, your body will gain back body points in short order. But you must rest. For each point below zero, you must rest 1 day. While resting, you can not perform any strenuous tasks. If your body points fall below -5, you must rest 2 days per point below zero. If they have to jump start you, then you cannot do anything for 3 days per point below zero. If you are brought back from the dead by using the "jump start" method, you must rest for 5 days per point lost below zero.

## THE EFFECTS OF DISEASES

Diseases can be crippling to characters, depriving them of vital statistics on a temporary or permanent basis. A disease often incapacitates, sometimes kills. PCs can take protective measures against diseases by getting VIS inoculations every 5 years. The VIS (Viral Infection Spectrum) are potent antibiotics injected into the body. It gives a bonus of +40 to biological SMR's for most diseases. The cost is 10,000cr.

## REPLACING MISSING LIMBS

Characters lose limbs during the course of adventuring. Missing limbs can be regenerated by acquiring the services of a powerful Zen Rigel or purchasing an expensive bio-regenerative drug called Nitreto-setilin. The drug has limited availability and is prohibitively expensive. The only other viable option is to purchase a bionic limb. Bionic parts vary in cost depending on the features of the artificial limb. Typically, a guy could get a bionic leg for about 40,000cr or an arm for about 20,000cr.





# BIONICS

Bionics is the study of how different races perform various physical tasks and solve certain problems. Cybernetics is the application of the findings to the design of computers and other electrical equipment. Characters who have surgically altered bionic attachments are called Cyborgs. Any character with the exception of the Mazian and the Mutzachan can be a Cyborg. The Mazian have no exact corporeal form, so the design of cybernetic attachments for a Changeling is considered impractical. The Mutzachans' physiological makeup is such that their bodies reject cybernetic implants. The Chatilians can utilize any bionic attachment, except skull units. This is due to the different biological infra-structure of their craniums.

Player characters may choose to become Cyborgs at any time during a campaign. One may also opt to start the game with a bionic makeup. Most players choose to take on bionic implants only after some incident or accident renders them limbless. The cost of replacing limbs with cybernetic attachments is prohibitively expensive and the loss of body parts has a direct effect on the body's constitution. Consequently, most characters do not randomly choose to spend 80,000cr on a pair of "glorified" legs.

Being bionic sounds great, but there are some major restrictions that go along with the job. First, one needs surgery to obtain bionic limbs. This costs a hell of a lot of money. A character who doesn't have the money on hand can not normally purchase cybernetic attachments. He may, however, seek alternative solutions.

A character may sign a contract, obligating him to work for a corporation who is willing to pay for the surgery. Any player who starts the game as a Cyborg is considered to be under the contract of a specific company, called the "sponsor". The corporation gains complete control over the person's life, delegating the new Cyborg to some type of combat or espionage duty. The contract is terminated when the loan is paid off. This usually take years. During that time the Cyborg has limited freedom. He is bound to the corporation and the corporation is authorized by the Galactic Commission Agency to implant a tracer unit which transmits the location of the Cyborg at all times. Any attempt by the Cyborg to remove the transmitter without proper authorization codes results in the immediate death of the borg. A tiny electrical transmitter shorts out the medulla oblongata and fries the cerebral cortex.

There are other shortcomings to being a Cyborg. Cyborgs are very susceptible to electrical discharge and EMP attacks. Either can kill a borg or render his limbs useless. Cyborgs have a SMR vs electrical shock of 25 and a SMR vs EMP attacks of 10. There is more. Cosmetic surgery is needed to cover bionic limbs. This costs an additional 25% above the retail cost. Most companies don't pay for it, unless the recipient is filling an espionage capacity. Many Cyborgs look like machines and most common folk don't trust or like machines. Third, repairing bionic limbs is expensive, and typically done only at large spaceports. Don't get me wrong!!! Being a Cyborg means that you are a walking, talking BAD %\$#@!! But it does have some shortcomings.

## THE EFFECTS ON CONSTITUTION

The loss of limbs, due to accident or any other cause, has a direct effect on the body's constitution. Constitution is lowered for every body part lost. The following table lists the effects of lost limbs on body constitution. The penalties are added up and the combined result is subtracted from the character's initial constitution score.

### CONSTITUTION TABLE

Replacement	Constitution Loss	Replacement	Constitution Loss
Per Hand or Foot	-03%	Ear	N/A
Per Arm (includes hand)	-07%	Throat	-03%
Per Leg (includes foot)	-15%	Lungs	-20%
Chest Cavity	-15%	Heart	-25%
Skull	-20%	Kidneys	-15%
Eye	N/A	Implants	N/A

## CONSTRUCTION COSTS (optional).

Players who opt to begin the game as a cyborg may, at the Battle Masters discretion, determine the amount of money that the corporation spends on them for bionic enhancement. Dice are rolled on the table below. The result is the amount of money that the character may spend on bionic attachments or enhancements. The character must repay the loan, along with a heavy interest premium. Typically, the Cyborg's wages are garnisheed 75% every pay period until the loan is repaid.

### CONSTRUCTION BUDGET

SCORE	RETAIL COST	LOAN
01-20	50,000	75,000
21-40	100,000	200,000
41-60	150,000	375,000
61-80	200,000	600,000
81-100	250,000	875,000

## ALLOCATION OF SPACE

Cybernetic limbs are mechanical and the internal machinery takes up a certain percentage of the unit's total space. Consequently, the body has only a small amount of available space for enhancements. The space required depends on the size and nature of the enhancement. All bionic features are given a unit size under the description. The size denotes how large the feature actually is, relative to the space available. The following table lists the unit space per limb that can be allocated to bionic enhancements. Note: all Cybernetic limbs and replacements are considered to have a base Threshold of 3.

TYPE	SIZE	COST	TYPE	SIZE	COST
Hand:	4	10,000	Eye:	1	5000
Arm:	15	20,000	Ear:	2	10,000
Foot:	5	5000	Throat:	1	12,500
Leg:	20	40,000	Lungs:	N/A	16,000
Chest:	35	60,000	Heart:	N/A	50,000
Skull:	7	75,000	Kidneys:	1	80,000

## SYSTEM ENHANCEMENT

**Increased Strength:** The internal structure of pneumatic and hydraulic drive systems can be altered to increase strength. Cost: 2000cr per point above the normal bionic strength rating of 100. Enhanced bionic limbs gain modifiers to damage dice as stated under the strength ability table.

**Increased Reflexes:** Bionic limbs have different servos implanted to increase the reaction time of the borg. Reaction time affects combat initiative. The cost is 20,000cr per point of initiative gained. The maximum adjustment is -4 to dice rolls.

**Increased Speed:** Bionic leg speed can be increased from a normal 32kph to 96kph. Each 1 kph costs 200cr.

**Electrical Insulation:** The cost is 200cr per point of modification. Each point adds 1% to the individual's electrical SMR.

**EMP Insulation:** Protects the borg from the effects of EMP based attacks. The cost is 500cr per point of modification. Each point adds 1% to the individual's EMP SMR.

**Microwave Insulation:** Protect the borg from the effects of microwave based attacks. The cost is 400cr per point of modification. Each point adds 1% to the individual's microwave SMR.

**Cosmetic Surgery:** Basic Cyborg surgery is non-cosmetic. Cosmetic surgery covers the limb and costs an additional 25% over the retail price for the item.



### CYBERNETIC EAR IMPLANTS

**Hearing Amplifier:** Boosts the hearing sensitivity. Hearing range is doubled. Size: 1 unit. Cost: 15,000cr.

**Transceiver:** A tiny micro-chip transmitter and receiver unit. The transceiver allows the Cyborg to transmit and receive radio messages. Transmission level is 105%. Range: 1km. Size: 2 units. Cost: 5000cr.

**Signal Detector:** Alerts the person to the presence of radar. The signal detector also picks up electronic emissions of any scanners that are focused on the character. It emits a soft pinging in the ear. The detection range is 160km. Size: 1 unit. Cost: 20,000cr.

### CYBERNETIC OPTICAL IMPLANTS

Chatilian and Python races possess inordinately large eyes. Cybernetic implants cost double the normal for these races. The storage capacity of such a large eye is three times normal.

**Optical Laser Unit:** A tiny, powerful laser unit, fitted into the eye socket. The unit is thought activated. An internal energy cell holds twelve shots and takes two hours to completely recharge.

Range:	80m	Accuracy:	80%
Damage:	1d6	ROF:	1
Charges:	12	Malfunction:	98
Size:	1	Cost:	5000cr

**Night Vision:** Amplifies and filters existing ambient light. One sees perfectly well in darkness, but cannot see in the complete absence of light. Size: 1 unit. Range: 135m. Cost: 4000cr

**Infrared Detection:** This unit is quite useful. It detects the differences in radiation levels emitted by all objects. The filter focuses on temperatures between 23 and 48 degrees celsius. Most living creatures give off radiation within these spectral bands. Size: 1 unit. Range: 135m. Cost: 5500cr.

**Zoom Telescopic Vision:** Long range, automatic focus and sighting system. Magnifies a 4m area. The Zoom lens is thought activated and deactivated and has an effective range of 800m. Size: 1 unit. Cost: 10,000cr.

**X-Ray Vision:** This cybernetic system scans through solid objects. It can pierce 500cm of concrete, 15cm of steel or 2.5cm of lead. Size: 1 unit. Range: 10m. Cost: 40,000cr.

**Ultraviolet Detection:** Provides the ability to see into the ultra-violet spectrum. All flux shields and high energy lasers can be detected. Size: 1 unit. Range: 35m. Cost: 10,000cr.

**Video Camera:** Takes electronic imaging photography. This unit comes with a built-in video recorder. It is capable of taking still shots as well as continuous photographs. Running Time: 45 minutes. Surgery requires some bone reconstruction. Range: 20m. Size: 2 units. Cost: 5000cr.

**Target Acquisition Computer:** Superimposes cross hairs on the target. The owner gains a 10% increase to attack rolls. Size: 1 unit. Cost: 15,000cr.

### SENSORY UNITS

Most sensory and detection units can be installed in a Cyborg at ten times the retail cost. This is subject to some fluctuation. Scanners and thermal detection devices are examples of sensors commonly implanted. All sensory devices take one unit of space.

### FOOT IMPLANTS

**Hover Jets:** Provides the person with limited flight capability. Vector thrusters steer the jets. The Cyborg thinks the direction and altitude. The unit responds. Maximum flight time: 4hrs/day, maximum speed: 100kph, maximum altitude: 3300m. Size: 4 units. Range: 380km. Cost: 60,000cr.

**Electromagnetic Boots:** These attachments create a powerful electromagnetic charge. The boots adhere to walls and smooth, metal surfaces. The Cyborg can climb walls. The unit is thought activated and the movement command is WALK and the stop command is STICK. Size: 3 units. Cost: 20,000cr.

**Climbing Claws:** Extendable hook shaped climbing claws, designed to facilitate climbing on vertical surfaces (+30 to climb checks). Size: 1 unit. Cost: 2000cr.

**Metal Detector:** Continuously scans for metals. It can detect objects up to 5m below the surface: Size 1 unit. Cost: 5000cr.

**Smoke Screen Generator:** Designed to screen attacks against a fleeing borg. The generator produces billowing clouds of smoke. Attacks against the owner are made at a -30 to dice rolls. Duration: 10 minutes. Refill cost: 50cr. Size: 2 units. Cost: 5000cr.

### HAND IMPLANTS

**Climbing Claws:** Matched to foot claws. Hand claws give +10 to climbing, cumulative with foot claws. Size: 1 units. Cost: 2000cr.

**Talons:** 5cm long and razor sharp, these claws are designed specifically for combat. They do a d8 damage. The talons extend and retract upon verbal command. Size: 2 units. Cost: 5000cr.

**Laser Welding Torch:** It cuts through normal tensile strength steel in seconds. 1 hr of use. Recharge cost 100cr. Size: 1 unit. Cost: 6000cr.

**Power Drill:** A forward and reversible high torque drill unit that comes with a small built-in compartment for additional bits. The bits never dull. Size: 2 units. Cost: 5000cr.

**Power Saw:** A self-sharpening unit that is designed to cut metal and wood. Size: 3 units. Cost: 5000cr.

**Glue Gun:** Squirts a highly adhesive glue compound. Hardens in ten seconds when exposed to air. Range: 3m. Size: 1 unit. Cost: 4000cr.

**Computer Interface Joints:** These are fingers designed to access computer systems. The fingers plug right into the computer. All programmed information obtained is at the use of the Cyborg if he knows the proper passwords. The stored information is changed to neural messages which are transmitted along the information response coil to the Cyborg's brain. The Cyborg can also send thought commands back along the command coil to the computer. The mental commands are changed into digital information and fed into the computer system. **COMPUTER INTERFACE JOINTS ARE ILLEGAL. ANY INDIVIDUAL POSSESSING THEM WILL BE PUNISHED TO THE FULLEST EXTENT OF GALACTIC LAW.** Interface joints are difficult to obtain and can only be purchased on the Black Market. The cost for the command and response coils is 20,000cr a pair. The cost for finger joints varies. The types of joints available include:

TYPE	COST
1. Military Hardware	20,000
2. Military Defense Systems	400,000
3. Flight Systems (atmospheric)	15,000
4. Flight Systems (space)	20,000
5. Galactic Bank Systems	1.0 M
6. Galactic Police	20,000

**Web Caster Generator:** The system fires adhesive webs up to a distance of 35m. The unit contains 20 charges. The generator is voice activated. Refills cost 100cr.

Range:	35m	Accuracy:	80/70/30
Damage:	Entangles	ROF:	1/3
Charges:	20	Malfunction:	98
Size:	2	Cost:	20,000cr

**BIONIC HAND AND ARM WEAPONS**

**Finger Gun:** Fires .22 caliber ammunition. Very similar to the old derringer style pistol. A size 1 reload compartment with 6 shots may be purchased for 1000cr. Reload Time: 6 sec. The compartment is normally stored in the thigh.

Range:	100m	Accuracy:	75/68/60/40/1
Damage:	1-6	ROF:	1/3
Charges:	1 bullet	Malfunction:	98
Size:	0.5 units	Cost:	5000cr per finger

**Finger Laser:** Fires a high intensity laser beam.

Range:	50m	Accuracy:	80/70/60/20
Damage:	2-8	ROF:	1
Charges:	20 shots	Malfunction:	1
Size:	0.5 units	Cost:	20,000cr

**Wrist Pulse Unit:** Has a low rate of fire compared to the laser, but produces a higher damage yield. This unit is large and takes up most of the space in the cyborg's arm. A maximum of 20 shots can be fired in a day.

Range:	50m	Accuracy:	90/70/20/05
Damage:	4-16	ROF:	1/2
Charges:	10 Shots	Malfunction:	100
Size:	6 units	Cost:	30,000cr



**Wrist Launcher:** Fires grenades up to 100m. No other units may be housed in the arm section. Five reloads are normally housed in a ten unit size compartment. The compartment is typically stored in the cyborg's leg.

Range:	100m	Accuracy:	70/57/30/10
Damage:	1-4 per fragment	ROF:	1/15
Charges:	1 grenade	Malfunction:	99
Size:	10 units	Cost:	20,000cr

**Wrist Rocket:** The launcher system holds three mini-missiles that can be fired simultaneously or separately. The guidance system is thought controlled, cross hairs being superimposed on host's eyes. This unit is normally fitted in conjunction with a telescopic zoom lens eye implant. Only one target can be engaged at a time. Reloads are carried externally and cost 500 per missile.

Range:	250m	Accuracy:	80/80/75/45/25
Damage:	4-24	ROF:	1/3
Payload:	3 missiles	Malfunction:	100
Size:	8 units	Cost:	50,000cr

**Electrical Discharge Unit:** Discharges a powerful electrical shock that will arc to the nearest target.

Range:	20m	Accuracy:	80/50
Damage:	2-12	ROF:	1
Malfunction:	100	Charges:	50
Size:	3 units	Cost:	20,000cr

**Flamethrower:** One reload is carried in a three unit sized leg compartment. When the canister is empty, it is removed and the replacement screwed on.

Range:	50	Accuracy:	110/80/45
Damage:	2-12	ROF:	1
Charges:	20	Malfunction:	99
Size:	5 units	Cost:	15,000cr

**Chemical Spray:** Discharges a cloud of chemical gas (smoke, toxin).

Range:	10m	Accuracy:	95
Damage:	By gas type	ROF:	1/3
Charges:	10	Malfunction:	100
Size:	4 units	Cost:	12,000cr

**BODY ENHANCEMENT UNITS**

**Toxin Neutralizer:** Filters the blood and removes poisonous toxins. The toxin neutralizer adds a +55 point modifier to SMRs vs biological and poison agents. Size: 2 units. Cost: 80,000cr.

**Gas Filtration System:** Filters out toxic airborne agents. This system adds a +60 modifier to SMRs vs atmospheric agents (biological or chemical). Size: 3 units. Cost: 70,000cr.

**Oxygen Supply:** The internal oxygen supply and pump allows the Cyborg to hold his breath for 10 minutes while underwater. Size: 3 units. Cost: 10,000cr.

**Reinforced Rib Cage:** Reduces the effects of damage to those internal organs that are located beneath the cage. All attack damage is reduced by 4 points. Size: 10 units. Cost: 20,000cr.

**Flux Shield Generator:** Creates a 3 Heavy Point flux shield that blocks out all damage. The generator is large and takes up 25 units of space. Destroyed flux shields take 30 hours to recharge. Cost: 400,000cr.

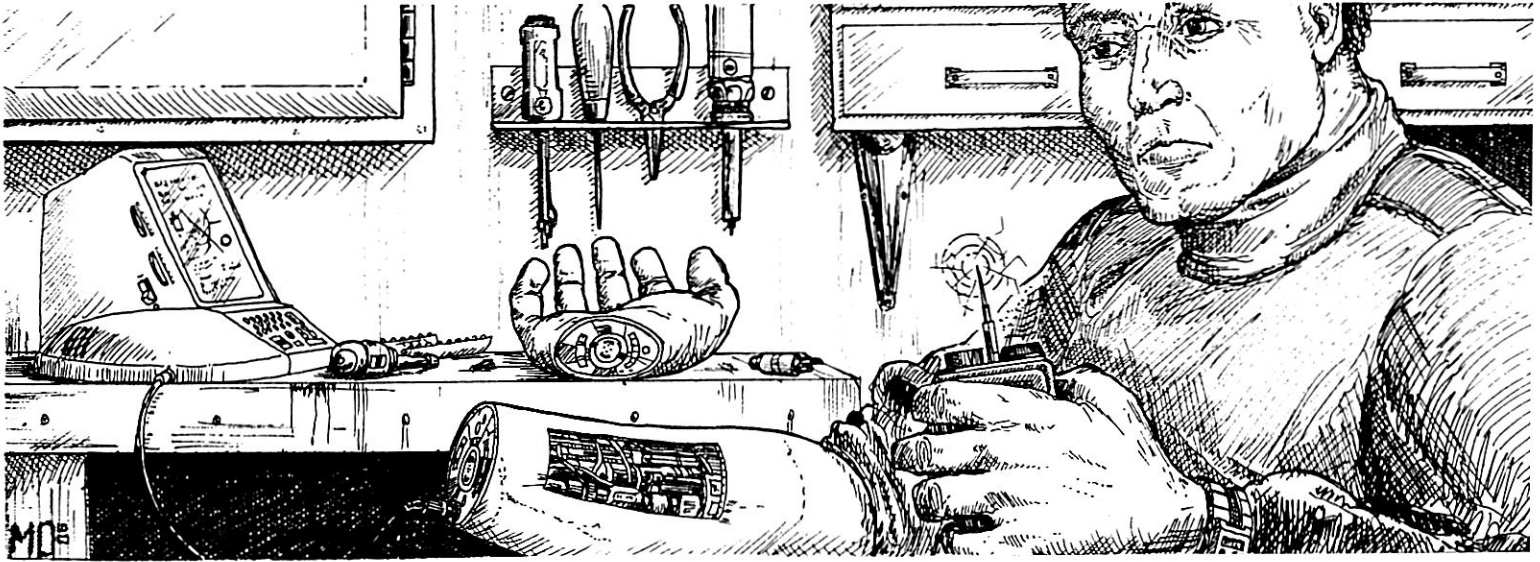

**Spinal Cage:** A flexible bionic structure that protects the spinal column. The cage reduces the effects of damage by 4 points. Size: 15 units. Cost: 15,000cr.

**Language Analyzer/Modulator:** A small computer unit is connected between the brain, throat, and ear. It registers and analyzes foreign communications by deciphering the information, then translating it into appropriate thought patterns. The Cyborg responds in the correct language. It is 80% effective. Size: 1 unit. Cost: 50,000cr.

**Sound Amplifier:** Raises the output of the Cyborg's voice to bull horn levels. Size: 3 units. Cost: 5000cr.

## SKULL ENHANCEMENT UNITS

**Bionic Skull:** A flexible protective unit designed to prevent damage to the brain. The skull has a 4 point threshold (in addition to the normal 3 point threshold). Size: 3. Cost: 10,000cr.

**Mind Screen:** Protects the mind from damage sustained from mental attack forms. The mind screen adds a +40 modifier to SMRs vs mental attack forms. Size: 3 units. Cost: 25,000cr.

**Sonic Suppressor:** Insulates the brain from the harmful effects of sonic disruption. It adds a +40 modifier to SMRs vs sonic attack forms. The sonic suppressor doesn't protect the body from the effects of sonic disruption. Size: 2 units. Cost: 25,000cr.

**Oxygen Supply:** A small compressor unit feeds the brain oxygen, in the advent of the shut down of the rest of the body. A normal brain can last four minutes without oxygen before brain damage sets in. It can survive six minutes before the victim dies. An oxygen supply feeds the brain for up to 60 minutes. Size: 2 units. Cost: 8000cr.

**Neural-Toxin Neutralizer:** The microcomputer is surgically implanted beneath the medulla oblongata. It registers the presence of foreign chemicals in the nervous system, then injects an antidote. It adds a +40 modifier to SMRs vs chemical attack forms that affect the central nervous system. Size: 1 unit. Cost: 15,000cr.

## IMPLANTS

Implants are small microcomputers inserted into a recipient's body then connected to the recipient's internal systems. Their function is to monitor specific biological activities within the host and to protect the body from certain types of attack. Implants are so small that they aren't visible beneath the skin. Beings like the Mazians have no central spinal system, but rather a huge network of neurons. Because of its shape-changing abilities, a Mazian can surround an implant and ingest it into its body.

**Adrenal Implant:** Attached to the pituitary gland in Phentari and Human types only. The Phentari's equivalent to the pituitary gland is called the Phis gland and is located in the center of the chest. The implant is sensitive to changes in the body's respiratory and circulatory systems. Increases in the host's bodily functions above a computed threshold activates the implant and causes it to inject the adrenal enzyme into the body. Strength and constitution checks receive an additional +25% bonus. Initiative rolls are made at a -2 to dice rolls. The adrenal implant can also be activated externally by remote control. The control is normally strapped to the wrist and the activation command sequence is punched in when bursts of adrenaline are needed. Due to the small size of the implant, the storage of the adrenal enzyme is limited to 60 one-minute bursts or any combination thereof. Refills cost 7000cr. The implant is very sensitive to electricity, and electrical attacks may destroy it. It has a SMR vs electrical attacks of 20. Cost: 10,000cr.

**Bio-Implant:** Similar to the neural-implant. It is attached to the liver and monitors the blood stream content. The bio-implant protects the individual from biologically based attack forms. It provides a +30% SMR modifier vs biological attack forms. Cost: 12,000cr.

**Electro-Implant:** A small portion of a finger, paw, or talon is removed and a small, very powerful, electrolytic capacitor is surgically implanted in its place. The capacitor stores a charge of 15,000 volts and has a discharge time of 2 seconds. The charge is released upon neural command. It does 2-8 points of damage to the target. An access port is hidden beneath the finger nail for recharging purposes. The implant requires one minute to fully charge. This system is electrically sensitive and can easily explode. It has an SMR of 20 vs electrical attack forms. Cost: 5000cr. Size: 1 unit.

**Needler Implant:** Widely used by assassin types, a small portion of an individual's finger, paw, or talon is removed and a unit containing a cyanide-4 capsule and needle firing assembly is attached. The device is cosmetically designed to look exactly like the removed member. Its true identity can not be determined without the use of x-rays, since it is made of a plastic polymer. Upon neural command, the needle is fired at the target. A normal "to hit" roll is necessary. If the assassin is touching the target, a +50% modifier is applied. The needle can be fired to a distance of up to 3m. The needle cartridge contains enough cyanide for 3 doses and reloads automatically. Extra needles can be purchased for 50cr each. Refills for the cartridge cost 2,500cr per dosage. The Needler has an 80% chance to strike a target at range bracket 1. Cost: 8000cr. Size: 1 unit.

**Neural-Implant:** This expensive device is used to stop the effects of chemical agents that attack the central nervous system. It can be used by all races, with the exception of the Mutzachans. The device is implanted in close proximity to the central nervous system. In humans,

it is placed under the skin, about 1cm above the kidney, just below the 4th lumbar vertebrae. Microscopic electrodes are then attached to the spine. Mazians have no such system, rather their entire body is composed of neural-nets. Since the race can shape change, the Mazian merely absorbs the device into its body. The implant senses the entrance of foreign entities into the spinal column. It reacts by attempting to analyze the type of intrusion, determine the correct neutralization serum, then mix and inject the serum into the body's system. It does this automatically. Systems operations are accomplished by a small micro-computer with production lab. The lab has minute amounts of fifty different chemical redox agents that can be

combined in different amounts to produce the correct antidote, all within seconds after the initial intrusion is detected. The implant is not always successful, but it provides a +45% modifier to SMRs vs chemical agents. Cost: 20,000cr.

**Sonic Implant:** This device is usable by any race, except lizard types and Mazians. Neither race has a discernible hearing system. This implant is the only type that the Mutzachan can use, since it requires no use of energy. The implant is surgically inserted behind the eardrum which utilizes a high frequency noise filter to block out noise above a certain threshold. The discriminator adds +30 modifier to SMRs vs sonic attacks. Cost 15,000cr.



## LEND LEASE

Independent groups can lease vehicles and spacecraft for their own purposes. There are many constraints that limit the Lend Lease possibility. First, no one in the agreement party can have so much as a traffic violation. Any type of police record automatically voids the possibility of picking up a ship. No one in the agreement party can have a bad credit rating or the same thing applies. To lease a spacecraft each member of the group must possess no less than 15 points of Deep Space operations skills and the pilot must have a minimum of 5 levels of pilot deep spacecraft. The lending company always does a brain scan to determine if the person is dishonorable or is of an unacceptable alignment, Infidel or Disruptor. Any person within the agreement party who is found to have beliefs similar to any of the above stated views, automatically voids a Lend Lease agreement. (Remember, mind shields are generally an effective means of getting around this type of problem). The group must put down from 01-07% deposit, depending on the vehicle they wish to lease.

The Lend Lease Agreement is usually for a 1 year period. The group agrees to pay anywhere from 01% to 05% of the cost of the vehicle per month for leasing rights. The group is responsible for the maintenance of the ship and must pay for all repairs. A transponder is implanted in the skull of each member of the agreement party. It broadcasts the location of that person at all times. Any attempt to remove it without the proper security codes, causes the implant to explode, instantly killing the person. (Requires a level 20-25 check to remove). If somehow, the group manages to remove the implants and steal the vehicle, then an APB (All Points Bulletin) is put out universe wide for their arrest and bounty hunters will be notified. Theft of a vehicle under Alliance law is punishable by death! If the ship is destroyed, and the crew manages to survive, then they automatically become property of the company until the cost of the vehicle is paid off, probably for the rest of their lifetime. Companies also retain the right to use a person for scientific research or manual labor. It is all there in fine print when you sign the contract, so if you wreck a 1 billion credit Bohemian class star cruiser, don't be surprised if you end up as experiment 14 in the Chem lab!

## MOVEMENT

Vehicles come under the same guidelines as other skills. The operator attempts to perform maneuvers and the BM assigns difficulty ratings as appropriate. Given below are some basic maneuvers and the difficulty rating assigned to them.

Emergency Stop	10	Power Turn	8
Bootlegger Reverse	12	Steep Slope	6
Change Lanes	1	Two Wheels	20
360% Pivot	5	Dodge Traffic	7
Jump	7-25		

Vehicle speed is expressed in kph. It is also stated in arbitrary terms to provide BMs with an easy frame of reference for movement values. Battle Masters will adjudicate distances. Turn modes affect vehicle control, affecting skill checks. The turn modifier to skill checks are given below. Negative modifiers indicate a bonus.

AAA	-30	C	+10
AA	-20	D	+20
A	-10	E	+30
B	00	F	+40

## CREW

The amount of crew space is given in terms of persons required to man the vessel/size class available. The number denotes how much space there is to fit persons comfortably. Twice as many persons can be fitted cramped.

## FUEL COST

Fuel cost denotes how much it costs to fill up the tank. Divide the fuel cost by the range to determine the cost per increment of movement.

## CARGO

Cargo represents the amount of extra space available for equipment storage. When applicable, cargo includes weapons payload.

## THRESHOLD

Threshold for vehicles operates exactly as with normal armor.

## ECM

Stands for Electronic Counter Measures. ECM equates a computer's ability to throw up enough electronic interference, so as to reduce the probability of lock on for firing purposes. ECM reduces the attack number. Thus, if a computer had an ECM rating of 30% and the enemy ship was locking on with a missile, then the attack number would be reduced by 30%. ECM jams weapons systems.

## ECCM

Stands for Electronic Counter Counter Measures. ECCM acts to negate the effects of ECM. The ships computer attempts to jam the jammer. ECCM reduces the effects of ECM on a point for point basis. If the ECCM number is greater than the ECM number then, the ECM is completely negated. However, a residual negative number is not added to the ship's attack number.

## FLUX SHIELDS

Flux Shields are defensive systems that surround the ship preventing damage. Weapons damage always strikes the flux shield first. Vehicle flux shields follow the same constraints as personal flux shields. (i.e. Normal kinetic attacks do no damage, lasers do half, and heavy weapons do full damage). All damage is subtracted from the flux shield before penetrating to the vehicle hull.

## INTEGRITY

Ship/Vehicle Integrity is the same as armor integrity. It represents the total amount of metal on the particular vehicle. The difference between armor integrity and vehicle/ship integrity is that vehicles don't have absorption. However, they do have hull. Thus, critical integrity denotes the amount of hull damage that the ship can take before personnel are in serious jeopardy. Below this number, you are in deep yogurt. The difference between vehicle integrity and critical integrity effectively equals absorption. If a vehicle takes damage above its threshold, then the residual amount is subtracted from vehicle integrity. The effects are cumulative. As long as a vehicles integrity doesn't drop below critical integrity, then personnel inside are safe.

## ATTACK MODIFIER

The attack modifier denotes the bonus chance to hit when aiming at the target. The gunner's chance to hit is increased or decreased by this number.

## CRITICAL HITS TO VEHICLE PERSONNEL

Whenever vehicle/ship integrity drops below critical integrity, persons inside the vehicle are subject to take damage. Persons inside ground and atmospheric vehicles are automatically hit whenever damage penetrates the hull. Damage is figured as follows:

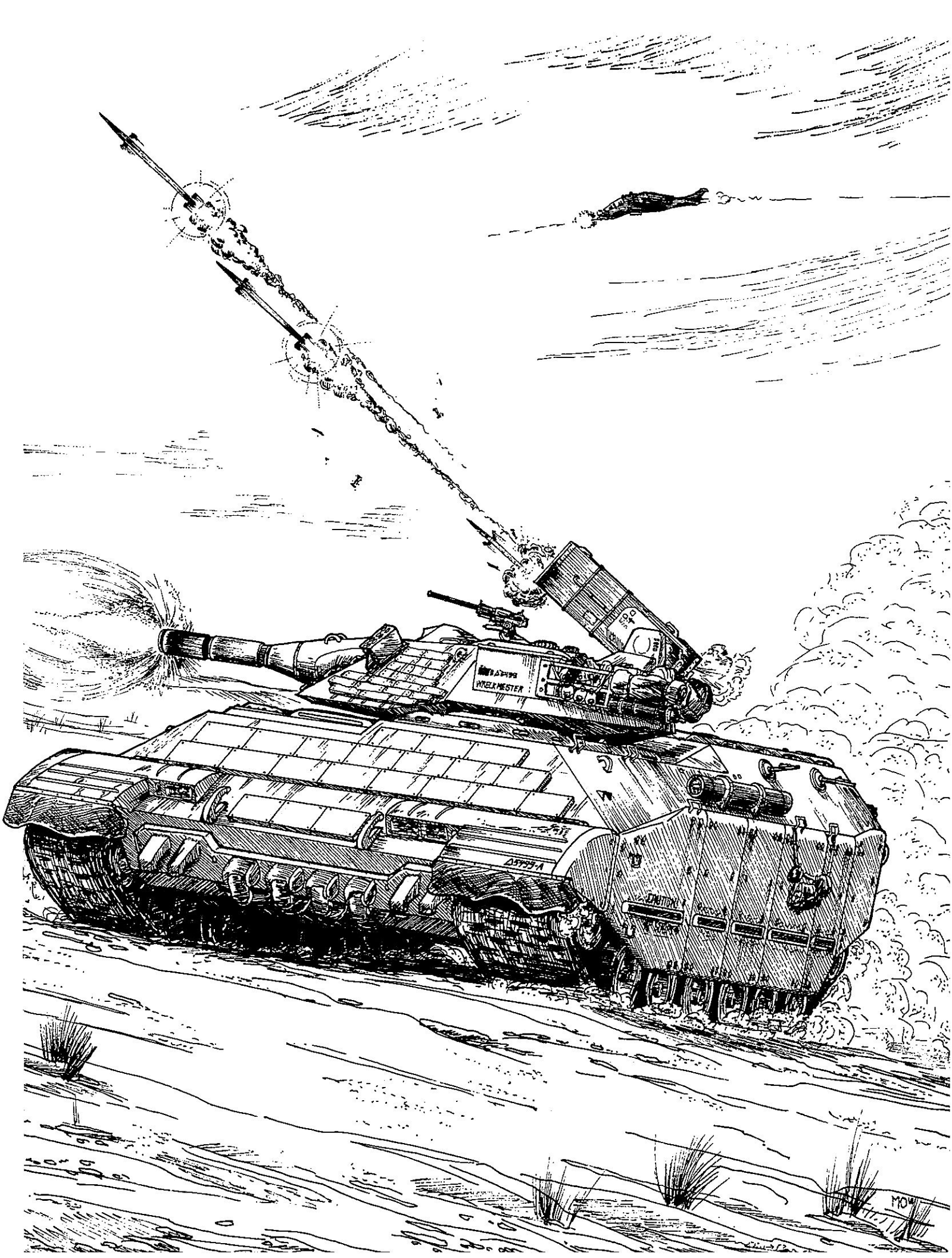



1. **Vehicle Concussion Damage:** Divide the penetrating damage by 5 and equally distribute it over each section of body armor.

2. **Vehicle Fragment Damage:** Persons inside vehicles are assumed to be hit with 1-8 fragments. Each fragment does 1/10 of the penetrating damage. So if 1HP penetrated (100 points), each person would be struck with 1-8 fragments that do 10 points each.

## CRITICAL HITS TO SYSTEMS

Anytime that penetrating damage does more than 1/4 of the critical integrity, persons must roll on the critical table to determine if a system has been knocked out. The penetrating effects are cumulative. Thus if 2 penetrating hits total more than 1/4 of the critical integrity then a critical hit has been obtained. Reroll any inappropriate result.

**NOTE!** Each time a critical is rolled there is a 25% chance that a fire has started.

**NOTE!** Each time a critical is rolled in space, there is a 10% chance of decompression.

01-20	No Critical
21-50	Engines
51-70	Cargo; includes ammunition (30% detonation)
71-80	Direct Fire Weapon
81-90	Missile Rack (10% detonation)
91	Maneuvering Controls
92	Speed Controls
93	Sensory Equipment
94	Life Support
95	Flux Shield Generator
96	Communications
97	Navigational Controls
98	Transporter
99	Med-Lab
100	Shuttles/Escape Pods

## VEHICLE COMBAT

The subject of vehicle combat seems to be touchy at first, as if there will be tons of rules to follow. Wrong! Battlelords of the 23rd Century deals with vehicle combat much the same as it does with other forms of combat. The scale is just different. All of the correlations between Vehicle and normal combat will be addressed below.

## SEQUENCE

1. Orientation
2. Initiative
3. Chose weapons to fire and fire
4. Resolve Damage

## VEHICLE VS VEHICLE COMBAT

First vehicles must determine their position with respect to each other. Initiative is rolled as per normal discharge combat, with the vehicle with the lowest aggregate score going first. A d12 is then typically rolled to determine what the target's position is with respect to the weapons that are being brought to bear against it. A d12 gives its profile with 12 being head-on facing, 3 and 9 being pure side profile, 6 equaling facing away and all other numbers equaling a modified profile. Consult the appropriate table below after deciding which weapon system to use, then roll to determine hit location.

## RANDOM ORIENTATION

Whenever a vehicle randomly pops into view, roll a d12 to determine facing. The resulting number is the clockwise orientation of the relative to you.

12 o'clock: Head-on Facing (-10 to hit)

6 o'clock: Facing Away (-10 to hit)

3 and 9 o'clock: Complete Side Profile (+20 to hit)

1,4 and 8,11 o'clock: Modified profile (+00 to hit)

2,5 and 7,10 o'clock: Modified profile (+00 to hit)

## INITIATIVE

Again, initiative is rolled as per normal discharge combat, with the vehicle with the lowest aggregate score going first. Character initiative modifiers are added to those of the vehicle.

## ATTACK NUMBER

The attack number equals the unadjusted chance for a weapon to hit at a given range bracket. It is modified by gunnery skill, and electronic warfare, cover, speed, etc. Once you have determined the target's orientation, you add in all modifiers to your skill and roll to hit.

To determine the modified Attack Number (hit adjustment):

- A. (Base chance to hit) - (ECM) + (Gunner skill) + (profile modifier) - (speed modifier) - (cover).

## GUNNERY RANGE BRACKETS

There are only four range brackets for gunnery skill, point blank, short, medium, and long range. Otherwise, they function exactly like normal weapons range brackets.

## APPLICATION OF GUNNERY SKILL

Characters add 04% per level of gunnery skill to the attack number of the weapon that they are manning. Thus, if a ion cannon (treat as pulse cannon) had an attack number of 80 at a given range bracket, and a person had 5 levels of pulse cannon skill, then he would have a  $(+04 \times 5 = 20) + 80 = 100\%$  chance of hitting the target.

## AUTOMOBILES

This is an ugly subject. Automobiles are outdated and impractical, but they do exist on Tech level 3 planets or lower. The cost of a new automobile runs from 6000cr to 40,000cr. The Battle Master will determine the cost of accessories, as well as standard options on different models. Specialized ground vehicles, such as dune buggies and the like, are a slightly different matter. A typical stripped down, straight from the factory, dune buggy runs 8000cr or more, due to supply and demand more than anything else. Again, the BM will determine the appropriate cost for special vehicles.

All automobiles may be "souped" up by adding weapons or defense systems. This is covered thoroughly in the sections that follow.

### Terms:

1Tkm: 1 thousand km.

1Bkm: 1 billion km.

**Critical Integrity:** When integrity drops below this number serious systems failures begin to occur.

**Vehicle Integrity:** The damage needed to destroy the vehicle.

**Size Modifier:** Gives the bonus to weapon accuracy due to size when heavy weapons are fired at the vehicle.

**Note:** This modifier assumes Anti-Tank and mounted weapons. Hand weapons receive an additional +40 to hit.



## MILITARY VEHICLES

**MTV-2 Bullet:** The Bullet is the preferred vehicle of Galactic Reconnaissance teams. This vehicle is extremely fast, accelerating from zero to 100kph in just under three seconds. It has a maximum speed of 300kph. Most sane operators ride it at 100kph or less. The vehicle runs off a Broxell/Jansen fusion powered engine. This engine is remarkably quiet and is non-detectable by human ears beyond 15m. The Delta 6 energy pack gives the Bullet a 300km range.

The Bullet mounts a Flex Glass bubble which locks to the frame, protecting the rider from harm. The bubble has an integrity of 25 points. The Bullet carries a communications rig with 220km range and fixes twin Vincennes laser cannons to its handlebars.

Vehicle Type:	Motorcycle	Threshold:	3
Crew:	1/6	Integrity:	70/50
Range:	300km	Flux Shield:	25
Fuel Cost:	10cr	ECM:	Nil
Speed:	300kph (9)	ECCM:	Nil
Turn Mode:	AAA	Att Mod:	-10
Cargo:	Nil	Cost:	85,000cr

Weapons:  
2 Vincennes 75/30/00/-20      Damage: 10-40pts

**Recon 7:** The Recon 7 ground vehicle is the basic reconnaissance vehicle used by exploration units on presumably hostile worlds. The rover much resembles the combat APC used by humans in the 20th Century. It is equipped with "lock up" capabilities for continuous operations under poisonous atmospheric conditions. When locked up, the crew is safe from the effects of biological, chemical, and radioactive attack forms. The Recon 7 carries a self-regenerative oxygen system. Thus, it can remain locked up for up to 40 solar hours. After 40 hours, the atmospheric intake filters begin to break down. Crews that remain locked up afterward run the risks of contamination. The rover may also operate underwater.

The Recon 7 mounts a parabolic enhanced high resolution camera. This device provides 180 degree forward plain view of the outside terrain. The driver manipulates the controls by monitoring the display on his control panel. When not in operation, the camera occupies a shock proof compartment in the tail section of the chassis. The rover has only one onboard weapon system, the M61 shock pulse cannon. The gun utilizes IFC (Internal Fire Control) technology. Cross hairs are superimposed on the visual display console. The weapon follows the path of the camera.

Vehicle Type:	Exploration	Threshold:	10
Crew:	4/22	Integrity:	600/450
Range:	1000km	Flux Shield:	5HP
Fuel Cost:	1800cr	ECM:	Nil
Speed:	70kph (2)	ECCM:	Nil
Turn Mode:	C	Att Mod:	+00
Cargo:	500kg	Cost:	9.5M

Weapon:  
M61 Shock 97/93/85/60      Damage: 1-4HP

**ATM 3 (Claws):** This rover is an multi-purpose all terrain vehicle, designed to conquer the most difficult "turf." Its primary mission is to deliver scientists to dispatch points. It comes complete with an onboard science lab. It can tackle a 45 degree climb, move through all but the thickest foliage, and "lock up" for underwater and hostile environment travel. Heavy foliage, such as trees, are cut down by the retractable saw blades mounted in the forward section of the hull. The tritium steel blades can cut through 10cm thick trees in fractions of a second. The ATM 3 utilizes a spiked/angle track system along with the ERA assembly for vertical assault. The ERA (Extendable/Retractable Armature) assembly contains heavy claws that dig into the ground and help to propel the vehicle up the steepest of surfaces. Hence the nickname "Claws." The ATM 3 isn't designed for combat and only has one small laser cannon.

Vehicle Type:	Exploration	Threshold:	10
Crew:	4/22	Integrity:	650/450
Range:	1100km	Flux Shield:	5HP
Fuel Cost:	1830cr	ECM:	Nil
Speed:	70kph (2)	ECCM:	Nil
Turn Mode:	C	Att Mod:	+10
Cargo:	500kg	Cost:	12.0M

Weapon:  
BF-3 80/35/10/-30      Damage: 6-36pts

**Panther Light Tank:** Is a highly maneuverable "shoot on the run" laser tank. It is used extensively by the GRF. The Panther integrates speed with long range target engagement capabilities. It's survivability is greatly enhanced by its low silhouette configuration. This tank, which first gained notoriety during the Arachnid Incursion, is capable of reaching speeds of 120kph. It suffers from one major problem. The fusion coupler bleeds energy. In the past, this flaw has resulted in critical power losses. The engine is currently being modified to alleviate the problem.

The Panther is constructed of plates of 6cm Flex steel, a lightweight metal alloy. It is further protected by a flux shield generator which puts out a 11HP force field. The tank sports a Ryker-1 double parabolic dish transfer laser gun. It has two short range Spread guns, one forward and aft. The tank carries five complete reloads for the guns.

Vehicle Type:	Tank	Threshold:	2HP
Crew:	4/28	Integrity:	50/30
Range:	800km	Flux Shield:	11HP
Fuel Cost:	1500cr	ECM:	10
Speed:	120kph (3.5)	ECCM:	10
Turn Mode:	B	Att Mod:	+20
Cargo:	Nil	Cost:	18.0M

Weapons:  
Ryker-1 90/55/20/-15      Damage: 2-12HP  
2 Spread 85/55/-20      Damage: 4-16pts (ROF: 7)

**Von Horsen (main battle tank):** It is fast and highly maneuverable. Against Arachnid counterparts, it has better than a four to one kill ratio. The Von Horsen is a highly prized catch of the Rebels who have somehow managed to steal more than one of them. How anybody manages to hide an 80 ton tank, is beyond explanation. The Von Horsen is equipped with the Ghost Holographic generator. This system allows the tank to pass without notice. This system incorporates a NRZ Infrared/Noise dampener. The tank is very difficult to detect by visual or sonic means. Thus, enemy radar units use doppler shifts to track invisible tanks. The Von Horsen utilizes an advanced electronic counter measure (ECM) system to deal with this problem. The onboard target acquisition computer jams doppler signals of enemy tracking systems. The P23-field gun is a short, fat barreled pulse cannon that can vaporize another tank with a single hit. The Von Horsen mounts a HMB flame canister to terminate close range targets. The canister can be fired 10 times. The Von Horsen also mounts twin, forward-fire Spread Guns. It has Sparrow surface to air missiles.

Vehicle Type:	Tank	Threshold:	5HP
Crew:	5	Integrity:	75/55HP
Range:	1250km	Flux Shield:	20HP
Fuel Cost:	2250cr	ECM:	+20
Speed:	150kph (4)	ECCM:	+15
Turn Mode:	B	Att Mod:	+15
Cargo:	8500kg	Cost:	35.5M

Weapons:  
P23 85/35/-10/-      Damage: 5-30HP  
HMB 80/30/-/-      Damage: 4-16pts (Effects: 5)  
2 Spread 65/15      Damage: 4-16pts (ROF: 7)  
Sparrow 100% out to 50km      Damage: 4-16HP

### COMBAT SHUTTLES

There are some 135 different fighters currently in use around the Alliance. Most are outdated. The competition to produce the superior fighter is fiercely competitive, so there are plenty of Tech Level 2-5 fighters available for purchase. Shortly after a fighter is produced, a rival company produces one that is better.

There are four types of fighters: Assault, atmospheric, trans-atmospheric, and deep space shuttles. Examples of three of the Tech level 5-6 fighters are given below. The Battle Master will furnish other fighters at the various tech levels as needed.

**A-30:** The heavy combat trans-atmospheric assault fighter carried on assault ships. It is launched into combat from orbit. This shuttle is "armed to the teeth", and heavily armored to ensure survivability. The A-30 is often used in an invasion support role. This vehicle is a two seat shuttle. The A-30 has a sophisticated ECM and ECCM computer onboard. The target acquisition computer for "bomb drop" is rated at 80%.

Vehicle Type:	Assault Sled	Threshold:	15HP
Crew:	2/16	Integrity:	22/19HP
Range:	10,000km	Flux Shield:	20HP
Fuel Cost:	50,000cr	ECM:	25
Speed:	2000kph (2)	ECCM:	45
Turn Mode:	D	Att Mod:	+30
Cargo:	15,000kg	Cost:	122.7M

<b>Weapons:</b>	
Massner 80/40/05/-	Damage: 20-80 (ROF: 6)
Pathfind 75% up to 10km	Damage: 6-36HP
BT-A 80% computer	Damage: 4-26HP

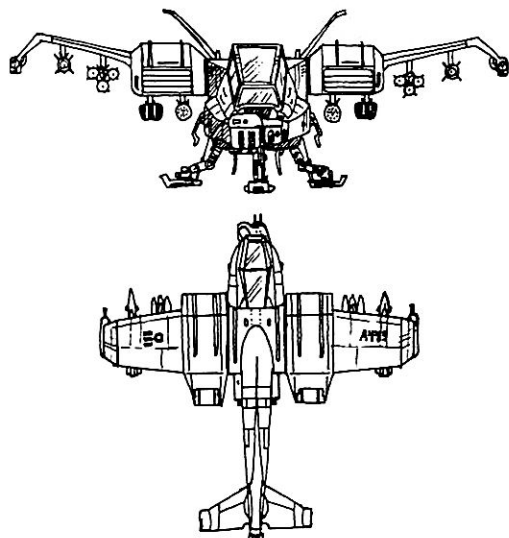

**SF-16 Tomcat:** The front line deep space fighter of the Galactic Defense Fleet. The SF-16 is often pitted against its inferior Arachnid counterparts. Galactic pilots normally score a six to one kill ratio. This single seat fighter is carried on all heavy carriers. The SF-16 carries 4 Bullseye anti-ship missiles and mounts a forward facing arc Desolation laser cannon.

Vehicle Type:	Fighter	Threshold:	12HP
Crew:	2/12	Integrity:	18/12HP
Range:	4,000,000km	Flux Shield:	30HP
Fuel Cost:	120,000cr	ECM:	40
Speed:	10,000kph (5)	ECCM:	52
Turn Mode:	AAA	Att Mod:	-40
Cargo:	Nil	Cost:	450M

### Weapons:

Desol	98/65/35/10	Damage: 2-16 HP
Bullseye	90% up to 300Tkm	Damage: 30-120HP

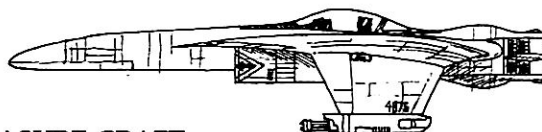
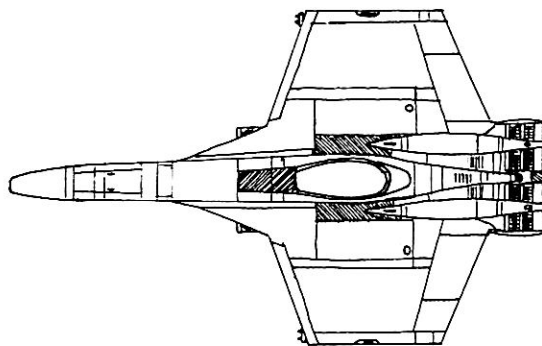

### PLEASURE CRAFT

Any law abiding citizen can purchase an efficient means of transport. Most cultures of Tech level 4 and above use fusion powered skimmers, hovercraft, and transcruisers to get from place to place. Air transport has been proven to be a more acceptable means of transportation, compared to outdated ground transport methods. Air transport is more energy efficient and causes less air pollution. All pleasure craft are equipped with an Internal Vehicle Radar Avoidance guidance system to prevent mid-air collisions. Aircraft are pre-programmed to avoid any object that approaches within 1000 meters. Pilots may operate vehicles in manual mode. While in manual control, vehicles are free to approach other craft.

Skimmers are low level, short range vehicles. All skimmers carry terrain avoidance guidance systems on board. They have a maximum altitude of 50m. Skimmers normally mount no weapons. Armor and weapons may be added though. They are economical and widely used across the galaxy. Since skimmers hug the ground, they can often avoid enemy radar.

The next most common pleasure craft available in the 23rd Century is the hopper. It is a low to medium altitude vehicle, capable of traveling long distances. Most Hoppers are atmospheric contained and attain speeds of 200kph. They often mount onboard weapons systems. Besides, they are nice for the family who doesn't want to be stranded "on planet."

The next type of vehicle available to the public, is the transcruiser. Transcruisers, often called PT boats (passenger transit), are atmospheric and trans-atmospheric capable. They are the most expensive of all the publicly owned vehicles. The only private means to reach a spacedock or orbiting hotel is to use ones' PT boat. Transcruisers represent another prize catch for pirates who use them for inter-planetary smuggling. Thus most PT boats carry armament of some kind, typically missiles and one heavy gun.

The final type of vehicle is the starcruiser, designed to transport personnel between systems by virtue of jump drive. Starcruisers are expensive, but are often used as commercial vehicles to transport and sell goods. No vehicle is sought after more by pirates than starcruisers. Listed below are some of the common vehicles available to the public. Battle Masters may add vehicles at their discretion.

### SKIMMERS

**Rockwell Bayliner:** The first widely produced skimmer. Marketed by Air Cam Corporation in 2158. This ancient wonder is unsafe in wind speeds of 88kph or greater. The air intakes clog up. You can, however, pick one up relatively cheap.

## Vehicles

Vehicle Type:	Skimmer	Threshold:	3
Crew:	1/6	Integrity:	150/100
Range:	400km	Flux Shield:	Nil
Fuel Cost:	40cr	ECM:	Nil
Speed:	140kph (4)	ECCM:	Nil
Turn Mode:	E	Att Mod:	-15
Cargo:	Nil	Cost:	25,000cr

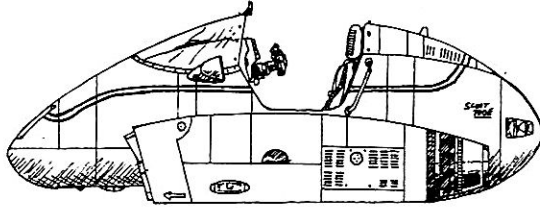

**Air Scooter:** Designed to carry one individual. This vehicle is a riding board and steering mechanism. It is cheap.

Vehicle Type:	Skimmer	Threshold:	4
Crew:	1/8	Integrity:	125/85
Range:	200 km	Flux Shield:	Nil
Fuel Cost:	20cr	ECM:	Nil
Speed:	100kph (3)	ECCM:	Nil
Turn Mode:	A	Att Mod:	-15
Cargo:	Nil	Cost:	17,500cr

**Hunter:** Designed as a fast and highly maneuverable skimmer for hunting purposes. The forward firing cannon utilizes "look and shoot" technology. The rear gun must be manned.

Vehicle Type:	Skimmer	Threshold:	4
Crew:	3/20	Integrity:	200/140
Range:	650km	Flux Shield:	Nil
Fuel Cost:	50cr	ECM:	Nil
Speed:	300kph (9)	ECCM:	Nil
Turn Mode:	C	Att Mod:	-10
Cargo:	100kg	Cost:	95,000

### Weapons:

.50 Cal 78/65/25/-10	Damage: 4-24 (ROF: 6)
Rear BF3 80/35/10/-30	Damage: 6-36

## HOPPERS

**Chrysalis Unlimited:** The "cadillac" of Hoppers. This unit is flashy, sporting a plush velvet interior, built in bar, Tri-V, interplanetary comlink, an atmospheric processor, along with a limited 5 year warranty on repair. The Unlimited has a large storage compartment in the lower rear section of the fuselage. This unit utilizes a centerline nose mount. The Unlimited cruises at a comfortable speed of 180kph.

Vehicle Type:	Hopper	Threshold:	50
Crew:	6/36	Integrity:	10HP/6HP
Range:	3000km	Flux Shield:	Nil
Fuel Cost:	1900cr	ECM:	Nil
Speed:	600 kph (3.6)	ECCM:	Nil
Turn Mode:	D	Att Mod:	00
Cargo:	2500kg	Cost:	1.0M

**Shelby S237:** Named after the specialized gas powered vehicles produced during the latter part of the 20th Century. One of the fastest hoppers on the market. The Shelby S237 comes factory equipped with an optional swivel mount for small weapons. It seats 4 comfortably.

Vehicle Type:	Hopper	Threshold:	40
Crew:	4/16	Integrity:	9/5HP
Range:	800km	Flux Shield:	Nil
Fuel Cost:	1200cr	ECM:	Nil
Speed:	700kph (4)	ECCM:	Nil
Turn Mode:	C	Att Mod:	-05
Cargo:	250kg	Cost:	600,000cr

**SR Penetrator:** Called the Flying Fortress. The Penetrator is a heavy combat hopper with a 10HP flux shield. Its 2HP threshold makes this vehicle formidable compared with others in its class. The Penetrator is produced with 2 wing hard points and 1 centerline mount.

Vehicle Type:	Hopper	Threshold:	2HP
Crew:	8/56	Integrity:	28/17HP
Range:	800km	Flux Shield:	10HP
Fuel Cost:	1500cr	ECM:	20
Speed:	500kph (3)	ECCM:	25
Turn Mode:	E	Att Mod:	+05
Cargo:	400kg	Cost:	3.9M

## TRANSICRUISERS

**Rockwell PC3:** This Pleasure Craft is the most affordable of the transicruisers, running just under 100.0M. This generic design comes with no extras. The vehicle has 3 hard points, one nose and two wing. Wings can only carry missiles. Cramped seating. Commo range: 5 Bkm.

Vehicle Type:	Trans. Cruiser	Threshold:	3HP
Crew:	4/20	Integrity:	20/13HP
Range:	5Bkm	Flux Shield:	Nil
Fuel Cost:	10,000cr	ECM:	Nil
Speed:	10,000kph (2)	ECCM:	Nil
Turn Mode:	C	Att Mod:	-10
Cargo:	2500kg	Cost:	99.9M

**Dassault Breguot:** Designed by the famous designers Jean Luc Dassault and Henri Breugout. Strictly a combat PT boat. The 5th person usually mounts the rotating inertial gun turret. It has 2 tractor beams and one transporter. One turret and two wing hardpoints.

Vehicle Type:	Trans. Cruiser	Threshold:	7HP
Crew:	5/30	Integrity:	48/32HP
Range:	20Bkm	Flux Shield:	20HP
Fuel Cost:	25,000cr	ECM:	30
Speed:	50,000kph (10)	ECCM:	15
Turn Mode:	B	Att Mod:	+05
Cargo:	10,000kg	Cost:	142M

## STARCRUISERS

**Micron Transport:** This tiny vessel is little more than an escape pod attached to jump drive engines. It can fit 20 size class worth of personnel for extended operations and mounts a single forward arc laser cannon (non-interchangeable).

Vehicle Type:	Star Cruiser	Threshold:	4HP
Crew:	4/25	Integrity:	30/25HP
Range:	20 parsecs	Flux Shield:	10HP
Fuel Cost:	50,000cr	ECM:	10
Speed:	25,000 (5)	ECCM:	05
Turn Mode:	F	Att Mod:	+10
Cargo:	25,000kg	Cost:	180M

### Weapon:

Desol 98/65/35/10	Damage: 2-16HP
-------------------	----------------

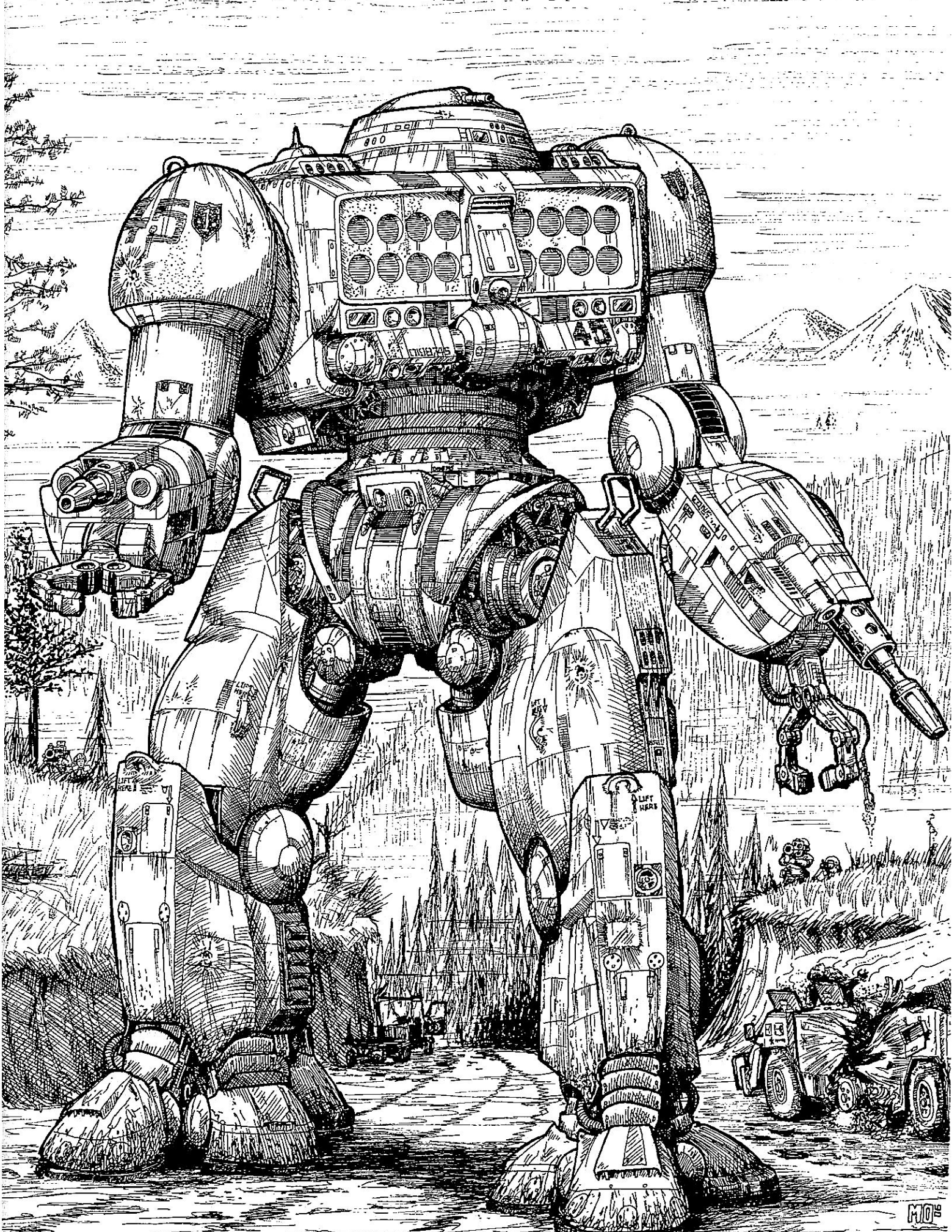

## Vehicles

**Bucketeer Transport:** This generic design is considered an affordable interstellar vehicle. It maintains a 100HP flux shield for combat operations and mounts twin swivel ball turret Dallas laser cannons. One of the more alluring features on the Bucketeer is its engine design which produces affordable gas mileage. Furthermore, the Bucketeer only requires 4 minutes to set the jump drive. Turret and 4 wing hardpoints.

Vehicle Type:	Star Cruiser	Threshold:	12HP
Crew:	5/35	Integrity:	60/42HP
Range:	40 parsecs	Flux Shield:	100HP
Fuel Cost:	80,000cr	ECM:	25
Speed:	30,000 (6)	ECCM:	15
Turn Mode:	C	Att Mod:	+10
Cargo:	45,000kg	Cost:	270M

Weapons:  
2 Dallas 99/85/60/35      Damage: 3-30HP

**Bohemian Class Star Cruiser:** Funkadelic! This baby is sweet! She is super fast, highly maneuverable, carries considerable firepower, and all for under 1,000,000,000cr! Bohemians are the favorite of Orions and this ship class is the mainstay of most pirate clan navies. The Bohemian Class star cruiser is an all purpose vehicle that can act as a cargo transport, passenger liner, or combat vessel. The Bohemian Class star cruisers are built in a special configuration that prevent catastrophic decompression. In the event of decompression, all compartments will immediately and automatically seal off. 7 Hardpoints: 2 centerline, 4 wing, 1 turret.

Vehicle Type:	Star Cruiser	Threshold:	25HP
Crew:	6/50	Integrity:	125HP/90HP
Range:	80 parsecs	Flux Shield:	200HP
Fuel Cost:	130,000cr	ECM:	35
Speed:	70,000kph(12)	ECCM:	45
Turn Mode:	A	Att Mod:	-10
Cargo:	100,000kg	Cost:	1.0B

**Turtle Freighter:** This slow moving behemoth is designed specifically for cargo transport purposes. It is slow, sluggish and virtually unable to defend itself in a combat situation. It has a single forward facing ion cannon. It does, however, possess a huge cargo capacity, and gets excellent "gas mileage." Hence, the name the Turtle.

Vehicle Type:	Freighter	Threshold:	8HP
Crew:	5/40	Integrity:	240/190HP
Range:	65 parsecs	Flux Shield:	40HP
Fuel Cost:	250,000cr	ECM:	05
Speed:	15,000kph (3)	ECCM:	Nil
Turn Mode:	F	Att Mod:	+40
Cargo:	400,000kg	Cost:	600M

Weapon:  
Washburn 140/120/90/80      Damage: 6-36HP (ROF:2)

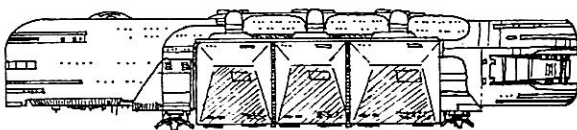

## ROBOTS

Robots are a common feature of society in the 23rd Century. They fulfill a variety of functions: working as maids, language interpreters, combat specialists, etc. Robots are capable of performing assigned functions faster and with more reliability than their organic counterparts. What they lack in intuitiveness, they make up for in

intelligence. They are extremely useful for gathering information in potentially dangerous areas. They are very expensive, but if necessary expendable. The following section gives a detailed description of some of the available robots. Battle Masters may add more as they see fit.

TAC means target acquisition computer. This represents the basic chance to locate a target. It is the equivalent of sighting, except that there are no range modifiers.

**BFR-1 (Basic Functions Robot):** Capable of performing up to 50 assigned simple functions. Limited capability. First built in 2016. The BFR-1 is useful as maid or gardener.

Height:	1m	Integrity:	25/20
Weight:	70kg	Threshold:	3
Cost:	6000cr		

**DAR-2:** The first formidable mobile robot. DAR stands for Data Analysis Robot. The DAR-1 was prone to malfunctioning. The DAR-2 has a fiber optics brain module. The artificial sensor neuron network organizes complex mathematical data and analyzes the information in seconds. The brain module performs computer, engineering, and science functions at a 3rd level of proficiency.

Height:	1.5m	Integrity:	35/25
Weight:	80kg	Threshold:	3
Cost:	20,000cr		

**Ramcor-R7:** This language interpretation robot is able to converse in 140 known languages as well as 20 machine languages. The unit comes with a built in language translator and can analyze foreign languages at a 10th level of proficiency. The robot is capable of translating machine language into its vocal counterpart.

Height:	2m	Integrity:	32/24
Weight:	250kg	Threshold:	4
Cost:	65,000cr	Abilities:	Language interpretation

**Recon-R2B:** Is an integral part of the Galactic Reconnaissance Force. This robot resembles a tall humanoid. The Z.E.C.S. (Zoom Eye Camera System) photographs potential targets. The R2B is programmed to automatically photograph all metallic and infrared radiating objects, or any moving target. The unit carries a smoke generator and an M-18L laser in the forward section of the head compartment.

Height:	2m	Integrity:	50/30
Weight:	350kg	Threshold:	5
Cost:	70,000cr	TAC:	65

Special Abilities: Photography, smoke generation.  
Weapons System: M-18L laser cannon.

**Ramcor-AR:** Designed by the Ramcor Corporation in 2094 for light combat duty. This robot is bipedal and it is programmed to target all doppler shifting or infrared radiating bodies. The robot functions in automatic or voice recognition mode. It mounts twin M-18L laser rifles in each arm and has a grenade ejector built into the chassis mid-section. The grenade launcher has a maximum range of 150m and an 80% chance, to hit at all range brackets. It has a storage capacity of 5 units. The robot's mission guidance program is protected and any attempt to modify the systems functions without proper codes, discharges an electrical shock which does 2-12 points of damage. The security system is rated at a 10th level of proficiency. Activating/Deactivating the robot is rated at a 12th level difficulty. The robot's body is protected with flex-plated armor.

Height:	3m	Integrity:	60/36
Weight:	425kg	Threshold:	6
Cost:	85,000cr	TAC:	75

Special Abilities: Infrared targeting.

Weapons Systems:

2 M-18L laser rifles and M-75 Grenade launcher.

**Shokan Killer (Hammer Head):** Nicknamed because of the oblong shape of its head. The robot was designed by the Nissoni Conglomerates in 2200. The Shokan Killer is a powerful combat robot. It targets infrared radiating and mobile sources and is equipped with twin Vector 4 pulse cannons, one in each arm. The Shokan Killer mounts a Bonoir anti-tank system in the robot's head section. The brain module is located in the chassis mid section. This combat robot has limited electronic defense systems.

Height:	2.6m	Integrity:	120/80
Weight:	700kg	Threshold:	10
ECM:	10	ECCM:	20
Cost:	1.0M	TAC:	90

Special Abilities: Infrared targeting, motion targeting.  
 Weapons Systems:  
 2 Vector 4 pulse cannons.  
 Bonoir Anti-Tank Missile System with 4 extra missiles.

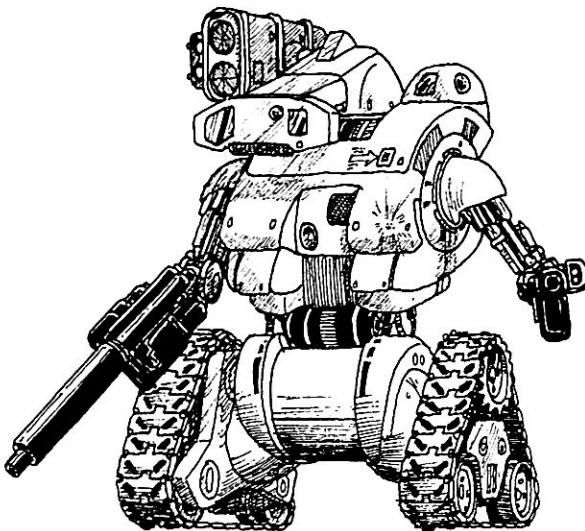

**ZRX-L4 (Thunder):** The first generation Warrior Class robot. Thunder is huge, standing over 10m tall. The ZRX-L4 was designed as a self-surviving entity. It performs over 100 non-combat functions at 5th level proficiency. The robot is equipped with a smoke generator in the right forearm and a RP-4 Masher cannon in the left arm. The hands have extendable claws for climbing. Thunder carries four shoulder mounted SAM-7 heat seeking missiles, 2 per shoulder. A M-80 pulse cannon is mounted in the forward section of the head unit. The radar unit is mounted in the rear section of the head unit (range: 300km).

Height:	10m	Integrity:	500/320
Weight:	7 metric tons	Threshold:	20
ECM:	40	ECCM:	40
Cost:	32.0M	TAC:	110

Special Abilities: Language analysis, Smoke generation, Radar.  
 Weapons Systems:  
 SAM-7 missiles.  
 RP-4 Masher Cannon.  
 M-80 Pulse Cannon.

**ZRX-L4A:** With the presence of heavy armor units, the basic ZRX-L4 needed modification to withstand weapon hits. This unit comes with a 10HP flux shield. It is the same as the ZRX-L4 in all other respects.

**MCR (Missile Control Robot):** The first heavily produced Warrior class missile robot. Stands over 40m in height. The Phase 3 radar system allows for simultaneous tracking of up to 50 ground, air, or space targets. The MCR carries 8 shoulder mounted SAM-7 surface to air missiles, 4 per shoulder. The chest cavity is loaded with 16 Scarren heavy missiles for armor engagement. The MCR can fire any two missiles per discharge segment. Each arm carries a HGM pulse cannon. The head section carries either 2 RKM lasers or 1 RP-4 Masher cannon. It carries a flux shield generator, rated at 10HP.

Height:	42m	Integrity:	40HP
Weight:	13 metric tons	Threshold:	4HP
ECM:	35	ECCM:	40
Cost:	76M	TAC:	125

Special Abilities: Radar, Flux Shield  
 Weapons Systems:  
 Scarren missiles.  
 SAM-7 missiles.  
 Twin HGM pulse cannons (Vector 4 ranges at 4-16 HP damage).  
 Twin RKM lasers (or one RP-4 Pulse Cannon).

### DEFENSE SYSTEMS

Players may opt at any time to enhance the ability of their vehicles by adding weapon systems or defense systems. All skimmers may carry only 1 weapon system, hoppers 4, and transcruisers by description. All modification to existing systems for transcruisers and Starcruisers cost 100 times the stated amount.

#### MODIFICATIONS

Atmospheric Purifier	5000
Body Armor: Per point	50
Per point of threshold (maximum of 10)	1500
ECM: Per 05 point modification	5000
ECCM: Per 05 point modification	5000
Ejection Seat	1000
Flux Shields: Generator	25,000
Per point of strength	200
Smoke Generator	2200
Stabilizers: Per 05 points	3500

### HEAVY WEAPON SYSTEMS

Any vehicle may be modified to carry weapons systems, though the number and selection is severely restricted by vehicle type. All pulse cannons require centerline mounts. They can be carried on any ground vehicle and on certain shuttle craft. Skimmers may only carry 1 forward facing weapon system, unless specifically noted. Hoppers may carry a maximum of four weapons, while a transcruiser can be modified to carry up to six.

It is assumed that each weapon has enough ammunition for 50 bursts before needing to reload. Lasers and pulse weapons use power reactors and don't require reloads. They do, however, require 15 seconds to cool down before firing again after having fired 50 shots. Deep space weapons have no malfunction or system shock numbers. Lasers require tremendous amounts of energy to fire, and thus they fire once every 10 seconds. Point defense systems can fire every 5 seconds.

It is assumed that these weapons and all other heavy weapons can fire out to the farthest effective range doing full damage. Those weapons that fire out beyond range bracket 4 have a maximum range of 5000m (500,000km for deep space weapons). The range of deep space weapons is 100 times the stated range bracket expressed in km.

Range Bracket 1: 75	Range Bracket 2: 200
Range Bracket 3: 500	Range Bracket 4: 1000



Vehicles

**ARCHAIC POWDER**

TYPE	1	2	3	4	M	SS	ROF	Dam	Cost
Spread	85	55	-20	-	99	90	7	4-16	5000
50 Cal	78	65	25	-10	99	90	6	4-24	10,000
XM414	85	80	60	00	99	80	10	2-7	28,000
LTX511	85	85	80	70	99	80	20	2-8	55,000

**LASERS**

TYPE	1	2	3	4	M	SS	ROF	Dam	Cost
BF3	80	35	10	-30	98	99	1	6-36	0.5M
Vincennes	75	30	00	-20	99	99	1	10-40	1.0M
Valley Green	85	83	40	20	100	99	12	5-20	4.0M
Shalkon	80	75	40	15	100	97	15	6-36	7.0M
Valley OX	90	90	70	30	100	99	3	4-40	2.0M
Ryker-1	90	55	20	-15	100	100	1	2-12HP	9.0M
*Massner	80	40	05	-	100	100	6	20-80	5.5M
**Desol	98	65	35	10	-	-	1	2-16HP	14.0M
**Aztech	85	85	70	55	-	-	1	2-12HP	12.0M
**Iroquois	90	90	88	85	-	-	1	4-16HP	15.0M
**Cherokee	95	95	92	90	-	-	2	5-20HP	18.5M
**Dallas	99	85	60	35	-	-	1	3-30HP	20.0M

**PULSE**

TYPE	1	2	3	4	M	SS	ROF	Dam	Cost
BC-Master	88	80	60	37	100	98	4	60-360	7.5M
M61 Shock	97	93	85	60	100	99	1	1-4HP	6.0M
Shalkon	95	95	85	52	100	99	1	1-6HP	7.0M
Washburn	110	100	90	35	100	99	1	2-8HP	9.0M
P23	85	35	-10	-	100	98	1	5-30HP	12.0M

**PROTON BEAM (PB)**

TYPE	1	2	3	4	M	SS	ROF	Dam	Cost
Data V	120	100	70	20	-	-	1	5-20HP	2.0M
Sigfreid 2	110	85	50	20	-	-	1	5-20HP	1.8M
Washburn	140	120	90	80	-	-	2	6-36HP	3.2M

PBs are mounted on trans-atmospheric and deep space craft only.

**MISSILES**

ATG: Air-Ground    SA: Surface to Air    SPG: Space-Ground  
 ATA: Air-Air    TA: Trans-atmospheric    SP: Space  
 STS: Surface-Surface    AMM: Anti-Missile Missile

Name	Type	Acc	Rng	Dam	Cost
Sparrow	SA	100	50	4-16HP	150
Scarren	STS	80	5	5-30HP	175
Spartan	STS	95	10	6-36HP	220
Pathfinder	ATG	75	10	6-36HP	180
*Unitech I	ATG	78	30	20-80HP	250
*Phoenix	ATG	127	70	10-60HP	225
*Helix	AMM	85	22	N/A	65
*Guardian	AMM	60	40	N/A	45
**Magician	AMM	115	200	N/A	100
*Sandbox	ATA	120	50	1-6HP	178
*Zenith	ATA	135	80	2-8HP	210
**Apogee	TA	115	82	4-16HP	350
**Apache	TA	100	60	3-12HP	266
**Bullseye	SP	90	300	30-120HP	900
**Midgetman	SP	115	120	20-80HP	800
**BearCAT	SPG	105	200	50-300HP	1200

NOTE!!! \* Only carried by atmospheric combat shuttles.  
 \*\* Only carried by trans-atmospheric or deep spacecraft.

**DESCRIPTION OF PLAY**

Navigator: I am picking up multiple bogeys. 200,000 km and closing. Going for IFF (Identify Friend or Foe). Scanning the hull.

BM: It is a foe. Space ionization potential is rated at 40%. You must

make a level 8 scanning check to obtain information on the hull. What is your unadjusted chance to lock on?

Navigator: I have 9 levels of Navigation and an Intuition bonus of +20. With a 50% base chance, well....(90 + 20 + 50 = 160). I have an unadjusted 160% chance to lock on.

BM: A level 8 check produces a minus 80 penalty in addition to a penalty of 40% for space ionization. The total penalty to hit is 120. 160 - 120 = 40. You have a 40% chance to lock on. Roll the dice.

Navigator: 32! Ok what type of ship is it? This is going to be easy!

BM: Arachnid Mauler.

Gunner: What? A Mauler! Oh, we are completely ?!/#\$. What are we going to do?..... I am firing all our remaining missiles.

Pilot: No! Wait. You stupid.....

BM: Too late. He has already fired. 6 missiles launched and on their way.

Pilot: You stupid !\$#?. It is going to vape us. We don't even know if she wants to board us. I hate Ram Pythons. I hate them!

Gunner: Human. Shut up or I give you the Death Knoogie.

Human: Fine I blow up the missiles.

Pilot: No! Stop!

BM: Too late.

Co-Pilot: Listen here Human. I suggest you tend to getting us out of here or I am going to have you on sandwich. Set the coordinates to make a jump. Now Human!

BM: Navigator. There is a flashing light on your console. The mauler has a lock on. Proton capacitors energizing.

Pilot: I am going into evasive maneuvers after the gunner fires. Level 7 intensity.

BM: OK. That will produce a 70% penalty for the Arachnids to hit your ship. Gunner. What are you doing?

Gunner: I'm firing both long range lasers. I have a 20% base chance to hit, plus 10 levels of skill at 04% per level. That gives me a 60% base.

BM: He has ECM up, rated at 35%. Are you putting up any ECCM?

Gunner: Our ship has 10% ECCM.

BM: 35%-10%. There still is a 25% penalty to hit. Your total chance to hit is 60% - 25% = 35%. Roll the dice.

Gunner: 89 Missed!

BM: He is firing. Hit!! He does 85 Heavy Points worth of damage to the flux shield. Your flux shield has 25 Heavy Points. So 60HPs penetrate it. Your ship has a 6HP threshold. 60 - 6 = 54. Your ship takes 54HP worth of damage. It has an integrity of 200HPs and a critical integrity of 150. 200 - 54 = 146. You have dropped below the critical integrity number. I am rolling on the critical chart. 94. Life support is out.

Co-pilot: Impressive Human. We'll just sail around the universe with nothing to breathe! Dinner time is now!!

# LIVING IN THE FUTURE

## THE ALLIANCE

The Galactic Alliance is the governing body of the known universe. The leaders of the member planets formed the coalition after the first Arachnid IncurSION in 2108 to protect the worlds of the Milky Way Galaxy from hostile invasion. The Alliance treaty was signed by the representatives from each race on the human flagship 'Foundation', in the year 2110. The Alliance was founded under the idea that an invasion from any outside force would be seen as an attack against all. A response to such an invasion would come from all protected worlds.

The present day Alliance is not merely a defensive force, it is the powerful governing body that sets Galactic law, controls intergalactic commerce, and dictates the civil rights policies of all controlled worlds. The 11,957 worlds are represented at the Council of Timar which regularly meets in New Washington to pass legislative matters and arbitrate disputes between nations. The Council is divided into four distinct branches: Executive, legislative, judicial, and administrative.

The executive branch is run by the President. His final say on all matters is irrevocable. Under present law, only Gen-Humans may be elected to this office. The Ward of State is second in command. The president always picks a Mutzachan to fill this position.

The legislative branch has representatives of each of the 11,957 worlds. It passes laws and is headed by the Chief Legislator, Bandal Ashhid. This position is freely elected by the people.

The judicial arm of the Alliance is the law-interpreting body of the Alliance. It is run exclusively by Hemareans, the logic-oriented race from the planet Hosi. Seven members sit on the Board of Truth to adjudicate matters of great import.

The final governing body of the Alliance is the administrative body. It is comprised of two sub-groups, the Intergalactic Defense Group and Galactic Police Force. The IDG is the military arm of the Alliance. It's primary responsibility is the direct response to outside invasion. It also puts down Rebel uprisings which are an all too common occurrence in the galaxy. The Interstellar Defense Group is presently headed by General Gar of the Python Republic.

The Galactic Police Force responds to domestic problems. Its major role is the capture of pirates who interfere with the flow of trade throughout the universe.

Now what's the real deal? The Alliance is controlled by a bunch of power mongers who are interested in gathering up more worlds to control. The exception to the rule are the Mutzachans. The problem is that they refuse to get involved in most matters. As long as something catastrophic doesn't occur, the Mutzachans don't want to have anything to do with it. They would rather sit around in their "ivory towers," contemplating the subtle nuances of those things which aren't worth thinking about in the first place! So everyone is stuck with the Gen-Humans, most of whom seem to be nothing short of "Little Hitlers." A bunch of megalomaniacs who run around, pawning themselves off as benevolent leaders, when in actuality they are nothing but a bunch of blood sucking leeches! The companies own all of the leaders who quietly line their pockets with graft. Corruption in its purest form. The government sets the standards for the industry and the industry owns the leaders who run the government (sounds familiar). The prospective deep space adventurer has several wonderful choices:

1. Run for President and clean house.
2. Become a Rebel and have the whole universe after you.
3. Sign on with a mega-corporation and accept the status quo.

## THE GALACTIC FORCES

The Galactic Forces Network represents all of the government controlled defense forces. Its primary mission is to ensure the survival and stability of the Galactic Alliance. What is so great about being in the services? Simple: everything! All soldiers have precedence when traveling about the galaxy. Any time that a Forces soldier seeks

transport to some location, he merely chooses a ship and gets on board. The service liner's parent company must make accommodations to suit the soldier's needs (within reason). The soldier does not pay for food or any other expenses while in transit. The company must pay for it. The cost of all normal lodging and food is half regular price. The soldier merely flashes his I.D., end of story. A Network soldier's base salary is high compared to that of the status quo. He receives the newest weaponry, and upon the termination of his commitment, the equipment becomes his. Why do all of this for a "Grunt"? Simple, you get incorruptible loyalty for a high price. That's what you need to run a universe.

The Galactic Forces will take only the cream of the crop into their ranks. Applicants are chosen on their past accomplishments, present vocational skill level, and general risk factor. The Galactic forces generally choose those who are law abiding. This cannot be overlooked! The Forces have over 200 billion applicants to choose from. For this reason, only the best are privileged to serve.

**The Galactic Marines:** The military force whose primary responsibility is engaging and terminating all ground force adversaries. It is primarily composed of Python Lizards, Ram Pythons, Phentari, and Gen-Humans. The Marines have an attrition rate of 12%. Base pay is 26,000cr per solar year for privates.

**Galactic Stormtroopers:** The elite ground unit of the Galactic forces. Responsibility: Initial contact and suppression of enemy ground units and the neutralization of hardened enemy positions. Attack modes include amphibious assault and atmospheric assault. Composition: 37% Ram Python, 35% Python lizard, 12% Phentari, 08% Cizerack, 04% Gen-Human, and 04% other. The attrition rate is approximately 23%. Base Pay is 30,000cr for privates.

**Galactic Reconnaissance Force:** Called GRF. It is a specialized branch of the Galactic Marines. It's responsibilities include the search and patrol of foreign territories in advance of the main body. Composition: 42% Cizerack, 40% Gen-Human, 15% Mazian, and 3% other. The GRF has an attrition rate of 16%. Base pay, 28,000cr.

**Galactic Navy:** The backbone of the Galactic Forces. The Navy is responsible for the transportation of troops to the battle zone, the engagement of enemy vessels, patrol of free space, and the suppression of planetary uprisings. Composition: 35% Gen-Human, 28% Human, 22% Eridani, 10% Mutzachan, 03% Orion Rogue, and 02% other. Attrition Rate: 06%. The base pay is 32,000cr.

**Galactic Fighter Corp:** A branch of the Galactic Navy. Its responsibilities include the protection of fleet ships, engagement of enemy combat shuttles, and the patrol of free space. Composition: 48% Eridani, 25% Gen-Human, 22% Human, and 05% other. Attrition Rate: 24%. The base pay is 35,000cr.

**Galactic Control:** An espionage group, its responsibilities include the monitoring of subject nations, infiltration of rebel forces, government security, the monitoring of corporate structures, and the assassination of "unfriendly's". Galactic Control recruits 40% Mazian, 30% Chatilian, 15% Gen-Human, 10% Human, and 05% other to carry out its clandestine operations. Attrition Rate: Confidential. Base Pay: 30,000cr.

**Galactic X:** The top secret, enforcer Unit. Responsibilities: Preservation of Alliance integrity at any cost. Composition: As needed. Attrition Rate: Confidential. Base Pay: Flexible, normally around 50,000cr.

Let's talk about joining the services. Well it makes about as much sense as trying to rape a rhinoceros! Most of you end up as bullet or plasma catchers. There are great advantages, but there are tremendous disadvantages. Like being asked to stay behind to slow down 100, 4m tall Star Trolls with your two handed sword.

## CORPORATIONS

If you ask any informed person, "Who really runs the Universe?" He will inevitably reply, "What are you? A moron? Corporations run everything. You must be playing Battlelords of the 23rd Century." This is when you reach out and smack him upside his head.

Governments may topple, but the mega-corporations survive. They are vastly complex organizations that wield incredible amounts of power. Corporations engage in every type of business imaginable,

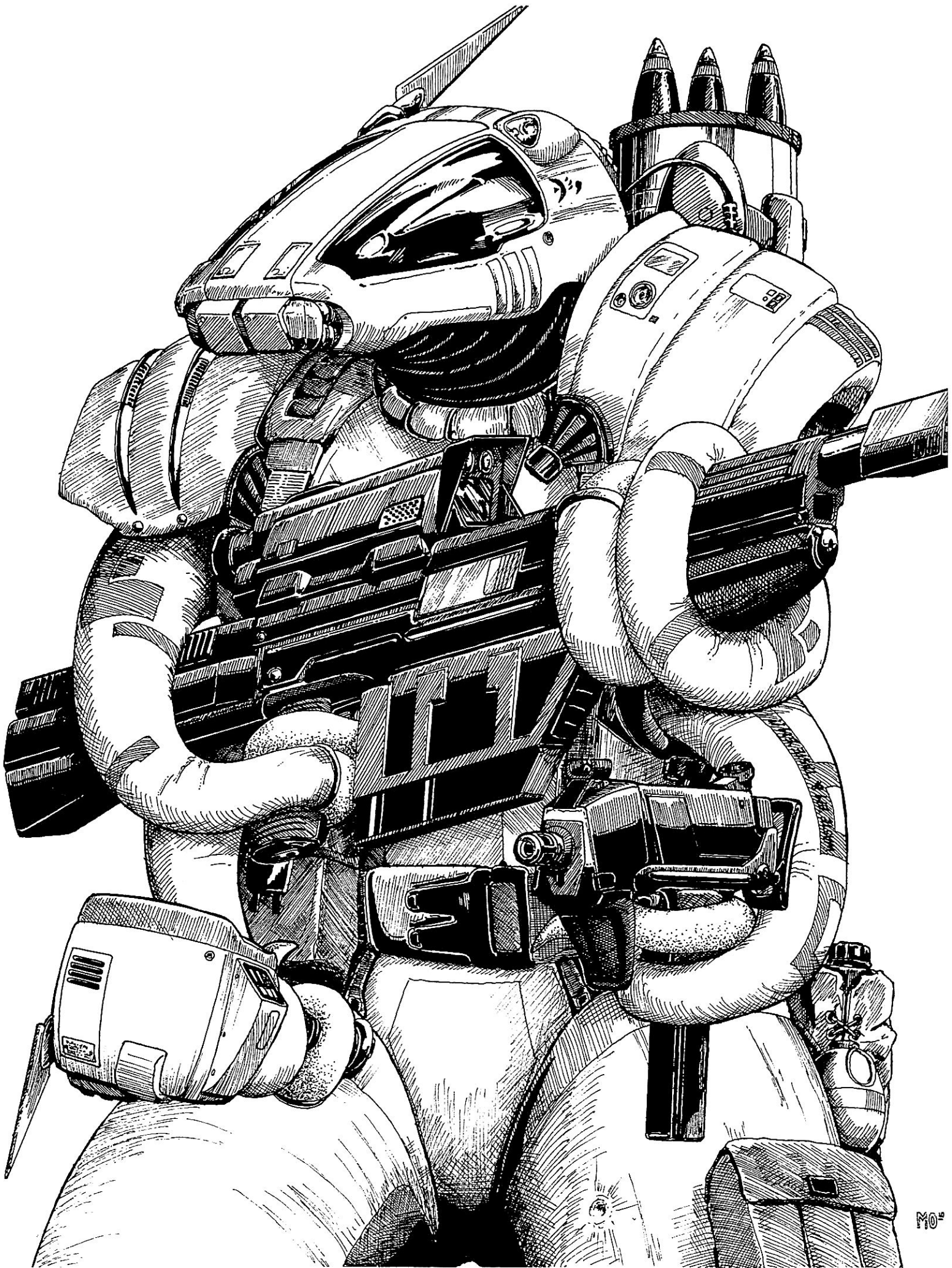

legal and illegal. Their illegal activities include gathering information, dealing in drugs, and hiring assassins. The mega-corporations buy and sell votes, control political parties, and appoint politicians. The list goes on and on. They may very well be evil, but it is probably a corporation who makes out and signs your paycheck.

## COMPANY GUYS

So you want to climb the corporate ladder of success, hoping to one day run the whole scene from behind a mahogany desk, squeezing your secretary, teeing off on the 14th green of the 1200 yard par 4 at the Moon River Canyon, and making a cool six digits a year by jeopardizing the lives of others, instead of yourself. Well there are a variety of company men that you will have to deal with on your obvious ascent to management. Deal with them as you see fit.

**The Brown Noser:** Someone please kill this guy. He spends his whole life "cheesing" up to the boss. The way I see it, he is sniffing out where the boss is going to go next and if the boss stops abruptly, he will probably break his neck! The Brown Noser courts favor by constantly praising "his majesty" and doing pathetic things to gain the boss's attention. But the Brown Noser does something else, he subverts any move you might make to get ahead. He undermines your actions by lying, losing your reports, and attempting to convince the boss you are no good one way or another.

If you catch a Brown Noser in your stuff, put on your battle gear, whip out a plasma grenade, and stuff it down his throat!

**The Straight:** This guy is the most up tight, anal retentive person in the world! He does everything by the book. He uses the company manual when he goes to the "john." Don't bend the rules or take any short cuts around this guy. He will surely turn you in. The Straight is a stickler for conformity and never deviates from the path laid before him. He will either like you or hate you, depending what your angle is on things.

The Straight does have some redeeming values though. He is super loyal. He has it all conjured up in his head that the company is greater than the self. If you ask me, I think he is a couple of bricks shy of a full load. Lastly, the Straight doesn't have a problem with jumping on plasma grenades and silly stuff like that. He will always cover your back in a retreat. He will always go back for the wounded. All in all, he isn't a bad guy, he just gets in the way a lot.

**Slick:** The greasy bum is always trying to get over. He is the ultimate "schemer". He has a plan for everything, never carries through with anything and wrote the book on short cuts. He is ultra-dangerous, because his ego writes checks that his behind can't possibly cash. He always overlooks the obvious. His supreme confidence in himself gets him and everyone else around him in trouble.

The Slick can come up with a great idea in the nick of time. He may get everyone killed, but it won't be because he lost his nerve in a firefight. Check his power and you have him under control.

**Slimeball:** My advice to you when you uncover a slimeball is simple. Frag him! No matter what, he is using you to attain his own gains and will "do" you in a second. So send him off to meet the Maker. He already sold his mother and is offering a good price on you. The problem is that he wears his colors well. It is hard to detect his machinations.

**Skate:** If you ask me, this is the most together guy of them all. He just does what is necessary to get by. He does what he has to and that's it.

## THE REBELS

The Rebels are the social dissidents of the Galactic Alliance. They are insurgents, well trained in the art of guerrilla warfare. Most are Humans or Zen Rigelns who actively or passively attempt to subvert the ruling government/establishment.

*"The Galactic Alliance is a dictatorship bent on the improvement of life for only a select few. Something must be done to check the uncontested powers held by the corrupt. These Gen-Humans are war mongers and run the Galaxy with the aid of their puppets, the Mutzachans. The masses are enslaved by their decadent values and are deprived of their basic constitutional liberties. The Gen-Humans dictate policy in accordance with the wishes of the powerful interstellar corporations. We must subvert the Evil Empire by educating the masses."*

Darnel Tram, Rebel Commander

The Rebels often conduct raids against Galactic supply depots in order to disrupt the flow of arms to warring nations. They occasionally starjack vessels, blow up factories, or start uprisings. Usually, Rebel forces provide military aid to uncolonized worlds. The Rebels have many military bases spread across the galaxy. These bases are mobile and can be moved quickly in the event of a Galactic Forces attack. The Rebels are mostly armed with second generation weapons, but some units have state of the art equipment stolen from depots. A Rebel space fleet exists and is quite formidable (some 150 ships.)

Any player may choose to be a Rebel. A character seeking to become a Rebel should travel to Katrell or Mars and make his intentions quietly known. You have to be low key and find someone in the resistance movement to take you in. Rebels stick together, a corporation would be more likely to stab you in the back than these guys. Furthermore, Rebels will generally arm agents for free. No they aren't going to give you a Devastator Omega cannon and Dreadnought armor! But they will "hook" you up as best as they can. Maybe the best thing about being a Rebel is that you aren't part of the problem, you are part of the solution. You see what is wrong and don't just accept it. You fight back and try to invoke a change.

## SPIES

The question seems to be, "Who isn't a spy?" There are thousands upon thousands of them working for the various networks. It is a profession that pays well to those who are bright and intelligent. It is also quite ruthless. Many a spy has awakened with a large hole neatly piercing the space between his eyes. Spies gather information, monitor the transmissions of unfriendlies, assassinate unwanted, etc. There are two basic facets of any spy network, espionage and counter espionage. Espionage includes intelligence gathering, infiltration of enemy positions, sabotage, and disruptive acts. Espionage agents are usually Mazian, because a Changeling is difficult to detect. The Mazian's arch-nemesis is the Chatilian Empath. Empaths are capable of detecting elusive intruders through the use of their inherent mental powers.

Spies work for either the government, a corporation, or the Rebels. All government contracted spies work for Galactic Control. Government spies have a base salary of around 35,000cr. Any character who has not been convicted of a felony can apply for a government espionage position.

Corporate spying is by far the most prevalent of the networks. Corporate spies engage in activities against competitive firms, carrying out assignments such as the theft of an adversary's product. Corporate spies earn an average base salary of 45,000cr per year.

The only other major network is the Rebel SCRAP, Surveillance/Counter Response Action Program. Working for SCRAP is very dangerous. These spies are employed to work directly against Galactic Control agents. The government agents have better equipment, facilities, and power. The starting pay for new Rebel spies varies, but it is around 20,000cr. **ANY PLAYER CAN CHOOSE TO BE A SPY, BUT ONLY A FEW WILL LIVE TO BE LEGENDARY ONES !!!**

Now, if you are a spy, then you are the "Coolest". You never walk fast. You squint with the best of them and you always have that self satisfied smirk written all over you face. You wear raincoats, even if its sunny out, always making sure to keep the collar turned up. Of course none of this applies to Mazians, but who cares. See, being a spy means that you get to go around sneaking, looking unimportant when you really are. You know stuff that nobody else knows. You think stuff that nobody else thinks and, most of all you might very well have a secret decoder ring!!!!

## THE ARACHNID PRESENCE

No one is sure exactly where they come from, but it is plainly clear that they do come. These bulbous creatures are the bane of the Alliance. They have invaded the galaxies twice, stopped at the cost of millions of lives. Their crab-like ships are twice the size of Alliance warships and are faster and better armed. One Arachnid ship is considered to be worth three Alliance ships of the same relative class. However, Alliance fighters tend to be better than their Arachnid counterparts.

Arachnids have a thick exoskeleton. Their carapace stops any attack that does less than three points of damage. The spiders are huge, having 60-100 body points. The few corpses that have been retrieved have weighed anywhere from 300-600kg. Reports verify that the spiders spit a gelatinous substance which acts like a web. They can fire it up to 50m. All Arachnids have a nasty disposition. Let's put it another way: all attempts at diplomacy with the race have failed miserably.

Arachnids wear body armor which makes them even more formidable in combat. Arachnid armor doesn't have absorption polymers, but it's armor threshold is rated at 7-11 points, armor integrity between 100-400 points. All damage must pierce the armor and then the body threshold. Arachnids carry small oblong devices which generate tremendous power. These weapons do 4-24 points of damage. All attempts to determine the functions of the weapons have failed. No one can figure out how they work. There appears to be no energy cell to supply power.

## PIRATES

All traveling passengers and ship owners have to be on the alert for Galactic pirates. Pirates can be of any race although most are Humans, Zen Rigeln, and Orion Rogues. Pirates lie in ambush, waiting to jump passing ships, then loot their cargo and valuables. Normally, all crew and passengers on the boarded vessel are terminated. Sometimes, a beautiful female will be captured for use at a later date.

Pirates fly modified starfreighters or occasionally a stolen luxury liner. Don't be mistaken: most pirates aren't directly involved in the capture of traveling spacecraft. They perform the menial tasks of gathering information about trade routes, departure times, and the nature of interesting passengers or cargo.

Any player can opt to turn pirate. There is much glory in it. If you are good, you'll be the scourge of the Galaxy!!! Every news chip will have your name in it. You will have many wonderful friends. Others will look up to you. You can sing that ancient stupid Earth song "Yo Ho Ho and a Bottle of Rum!" You can kidnap beautiful females/males and make them your slaves. You can adorn yourself with other peoples stuff. Secret bank accounts! Lots of money! And if you get caught, you'll be EXECUTED!!!

## BOUNTY HUNTERS

Bounty hunters are a common element of society in the 23rd Century. They are cold, ruthless, combat types who get paid handsome amounts of money to locate, restrain, or terminate fugitives of Galactic Law. They are Federal Marshals with a license to kill. Most are Phentari, but bounty hunters can be of any race. They work as independent contractors for companies. Most corporations are government owned. Companies not under Galactic control can still hire bounty hunters, but require a special permit. Bounty hunters have limited immunity against prosecution. All bounty hunters have legal right of passage on any Galactic vessel.

There are three different classes of bounty hunter as determined by the classes of license that they hold. The class one license cost 50,000cr, the class two costs 100,000cr, and the class three costs 250,000cr to obtain. Bureaucracy is rampant across the Alliance. Therefore, it takes 4-16 months for the license to be processed and granted. Over 70% of all bounty hunters are Phentari. These shrewd squids are treacherous, although they do follow the general precepts of the law (as long as it suits them). 18% of the bounty hunters are Gen-Humans, 10% Human, and 02% other.

There are Sheriffs, Rangers, and Marshals. The Sheriff is the lowest bounty hunter. They are commonly recognized by the gold cape which they must always wear while on duty. They must first obtain a court order before they carry out any type of activity. They are only allowed to apprehend criminals. Under no circumstance are they justified in shooting to kill. Now if a stray plasma blast catches someone in the head, well the bounty hunter usually will take up his defense in a court where he has the best counsel available and lots of sympathizers.

The red capped Ranger is the next highest bounty hunter class. He is given a wide range of authority and is able to terminate wanted criminals as he sees fit. The Ranger must have a court order to do so, but need not seek to restrain those who are wanted. He is allowed free passage anywhere and at any time. He may bump persons off flights to obtain that passage. Rangers also receive a 25% discount on all merchandise. One is usually a Ranger for 2-8 years before obtaining a class three license.

The highest class bounty hunter is the Marshal. These are only the most trusted law enforcers. One's record must be virtually spotless if you wish to have any chance of becoming a Marshall. The Marshall can enforce the law as he sees fit. He is not required to wear any cape, and has free reign wherever he goes. He has the right to take any suspect prisoner. He is liberally bound by the law of the Alliance and often operates as a justice seeking maverick. Marshals can purchase any item at 50% off the list cost. Very few Phentari have ever been posted to this position.

## COMMON FOLK

Most people are not warriors like you guys. On the contrary, they go about the boring routines of everyday life. Common folk approach living with the listless zeal of those who are unenlightened. They are blue or white collar workers, absorbed in the basic struggle to put meat or grain on the table. Most civilians view combat types with a combination of fear and suspicion. Most people tend to avoid direct confrontation or communication with combat types, yet some young, brash civilians are willing to help you out.

## HIRELINGS

Player characters may need to secure the skills of workers for some task. This can be done by checking the Reader Board at your local spaceport or consulting employment agencies in the nearest city. Hirelings usually ask for an advance in pay. A typical hireling expects anywhere from 200cr to 2000cr a week for his services, for a hired hand won't normally enter a hostile environment.

## MERCENARY GROUPS

**The Dead Man Replenishment Fund:** "So every time you go out, a couple of your buddies don't return. Too many people returning mangled from combat? And you can't seem to find any other sucker to join up with your group? Well don't fret. Come see us, the Dead Man Replenishment Fund. We are located on some 200 planets universe wide, with some 40,000 personnel available and at your service. Open 30 hours a day! Call anytime at 231-444-777-898-IDIOT."

The Replenishment Fund rents out mercenaries cheap, with daily or weekly rates. Their mercenaries have a Personal Loyalty Rating of 55% which is kind of low. It is best to hire out their personnel for low risk areas.

**Wax 'em and Fax 'em Liquidation Services:** "We Kill More People By 9 o'clock than most people do all day. Matter of fact we kill more people by 9 o'clock than most people do in their entire lifetimes."

The Liquidation Service is composed exclusively of Phentari and Ram Python types. They cater to groups led by Humans and offers a 20% discount when employed by them. This company leases its personnel on a 3 month basis at competitive rates. Excellent Personal Loyalty Rating of 85%.



**The Knights of Discipline:** The Knights of Discipline are a renowned group of Eridani Swordsaints who make their living correcting the wrongful doing of others. The 10 Knights make their home on the ringed world Eridine and pay their own way to the battlefield. The Knights of Discipline are staunch believers in Galactic Law and run a full police screen on perspective clients. The group is headed by Ermithar-ican, a fanatic who is bent on the obliteration of the Phentari race.

If someone has done a grievous wrong to you and you can't afford to hire out a group to gain restitution, call on the Knights of Discipline.

**Waste 'em and Taste 'em Combat Assistance:** An exclusive group of ex-bounty hunter squids. Wastem and Tastem, also known as the WTCA, specializes in legal assassinations and food service management, (killing and digestion of humans). The WTCA has extensive connections within the Alliance and is known to hold favor with the Phentari government who has intervened on several occasions to get arrested WTCA personnel off the hook. The WTCA also has excellent Black Market contacts and boasts that there isn't a weapon anywhere that they can't get their tentacles on. Personal Loyalty rating of an abysmal 35%.

**The Battlefield Janitorial Service:** "When it is all said and done a janitor is always sent in to clean up the mess. We Zen believe that a happy person is a living person. We stand by our motto with some 35,000 surviving clients. Remember, life is a precious commodity to waste, especially if it is your own."

This company hires out combat medics. The cost is based on a weekly rate and the experience of the Zen. The base cost is 5000cr per week plus an additional 2000cr per level of the Healer above 1st.

**The Chatilian Interest Firm:** Strictly an espionage/counter-espionage service. The Interest Firm is a reputable group composed largely of Chatilian Empaths. This small corporation of 55,000 hires out its personnel for espionage and counter espionage missions at a reasonable rate. The cost depends on the complexity of the mission and whether or not the agent must go into crowded areas. Rates start out at 500cr per day, plus 1000cr per level of the empath above 1st. All rates are immediately doubled if the empath is forced to work in an urban area.

**The Zen Hospital Firm:** Another combat support organization that provides combat medics to the battle zone. If you are looking to hire a Tza Zen, well someone in the firm will most likely be able to help you, at double or triple the going rate of 500cr per day per level of skill of the Zen. The Zen Hospital firm also is a licensed distributor of Biological Redox agents and other pharmaceutical drugs. All clients of the Zen Hospital firm are entitled to purchase up to 5000cr worth of emergency medical equipment at 10-25% discount. Parties may make only one such purchase per year. The Zen Hospital firm doesn't make background checks, and it is under investigation for unlawful practices by the Zen Rigel government.

**The Arachnid Suppression Guild:** "Do you have undesirable pests in your neighborhood (star system)? Are you constantly being plagued with large spiders wandering around killing and eating your friends and children? Well, if so call us. We would like nothing more than to eradicate all those nasty bugs."

The Arachnid Suppression Guild is the only organization that actively seeks out the destruction of Arachnid spiders and their pals, the Demonant, Sau-Bau, and Warlockin. Expect to pay 200,000cr minimum per day to render the services of any one mercenary from this prestigious guild. But if any independent group can take care of Arachnids, it is these guys. They pack state of the art equipment such as Mechanized Battle Armor and Target Independent Engagement Systems. Warning!! The Guild takes no responsibility for any damage that may be done to places within the fire zone.

**The Special Delivery By Missile Group:** "We're the SCUD people and we guarantee that you won't even see the enemy when we scatter him all over the universe. We believe that you should use technology to

destroy your enemies at long range."

The Missile Group uses high tech missile systems to engage enemy armor and personnel. The specialists are furnished at a rate of 5000cr per day per level of skill in their trade. Warning: you must furnish the munitions which can be purchased from the company at 10-50% off of the retail cost. Also, parties can order ground to ground, air to ground and, surface to air missile from the Special Delivery by Missile Group. However, it does take 1-4 months for delivery.

**The Computer Connection:** "Hack! Hack! Hack! Now just stand back while we crack that main frame stack. We sell computers. We buy computers! But most of all we break the security codes on computers."

These are the guys you go to when you need to access a system that looks impervious. They have amassed an excellent record of 4513 breakthroughs, 110 failures, only 65 dead, 123 wounded, and 14 captured over the last 10 years. The services of a computer hacker cost 1000cr per difficulty level of the computer. Double that if the hacker is exposed to danger. (Oh, by the way, police are considered dangerous.) If the hacker is captured, he will take all of the blame. Payment for the services to be rendered is made up front and is based on the type of unit or program to be cracked. They employ 850,000.

**The Energy Advisement Council:** Rents out the services of Mutzachan energy controllers for what ever purposes the client has in mind. Fees range from 1000cr per day for a first level controller to 500,000cr per day for 20th level controllers. The company does not employ any controller above the 20th level due to federal law. Hazardous duty contracts double the cost for "melon head" rentals. The company emblem is that of a huge earth style watermelon.

**Fun Loving Axe Murderers:** Notorious for leaving the blade of an axe buried in the head of the victim. These mercenaries are tough, and come equipped with a wide variety of heavy weapons. There are some 10,000 Axe Murderers universe wide. If you are looking for finesse, get somebody else. If you are looking for results, you might want to drop them a line. The group is mostly composed of Cizerack, Phentari, and Humans who have gone awry in the eyes of society. Rates vary from 500cr per day and up. If you have a tight budget, consider the Fun Loving Axe Murderers. Fail to pay up and there is a blade with your name on it. Loyalty base 70%.

**Picket Fence:** It is part of the Black Market and exercises its pronounced ability to launder huge amounts of money on a continual basis. The Picket Fence is also good for selling super hot items that might never cool down. Services are top secret and patrons must have had prior dealings on the Black Market to have any hope of doing business with the Picket Fence. The fence commands a full 35% of the fenced value for the goods. Personnel who deal often with the Black Market can obtain loans though the Picket Fence. The Picket Fence has some 50,000 members.

**Underground Assistance Firm:** Patrons can purchase false identification from the Underground Assistance Firm which operates as a galaxy wide travel agency. It is currently under close scrutiny by the federal government. The cost is 2000cr per level of forgery for personal documents. Official documents sell for 5000cr per level of difficulty. Why? Because if the forger gets caught, he goes directly to jail, do not pass Earth. Do not collect 200 credits.

The Underground Assistance can provide safe haven for fugitives for 50,000-100,000cr per month. This corporation is based on 200 different worlds. It has connections for plastic surgery and DNA masking and augmentation.

**Jim Jones and the Bad Boys From Guyana:** This mercenary group originates on the planet Guyana in the Carina Galaxy. The owner Wilford Nash, a noted historian who became disenchanted with the idea of pouring over boring text for the rest of his life, changed his name to Jim Jones after the Ancient Earth cult Leader of the same name. Shortly thereafter, he founded his own mercenary group. His motto is "spill a lot of blood." The Bad Boys are fairly cheap for the money. They wear Bear armor, but carry a variety of weaponry. They can be rented out for as

little as 300cr per day, but cost 3 to 7 times that much for combat missions. There are 400 Bad Boys. Easily picked out by the fact that they always wear jungle fatigues.

**Cyberdome Unlimited:** This large firm rents out the services of its Cyborgs at an exclusive 10,000cr per day base rate. Cyborgs are quite useful in urban combat and this small company of 200 people boasts that it produces the most formidable combat Borgs available. The results aren't in yet on this company which was founded only a year ago. Patrons are entitled to a 10-40% discount on all cybernetic limbs and implants.

**Angus Core and the Merchants of Doom:** Maybe the Ram Guard are more famous, just maybe. But not by much. Angus Core and his 9 "Disciples of the Faith" are living legends. This friendly and amicable bunch is composed exclusively of Humans and Orions Rogues, with the exception of Cushira the Cizerack cat. The Merchants of Doom have gone up against the Arachnids 5 times successfully, and didn't even take a single hit on two of the occasions. This seedy looking group has also survived three Rift runs and singlehandedly put down a coup against the King of Morokania after his daughter was brutally murdered. The group has amassed over 45,000 confirmed kills to its name, at the loss of only one Disciple, (Codil Canthral the Orion who tried to do single handed combat with a Sau-Bau while butt naked, stumbling drunk, and armed only with a chicken bone and a Savage-B laser pistol). The group is known for its raucous party antics, its less than proper manners, and its wonderful story telling. Angus Core and his Merchants of Doom are a favorite at the Council of Timar and rumored to be drinking buddies with the current President.

**The Phentari Selection Firm:** The largest independent bounty hunter organization of its kind anywhere in the galaxies. If you want someone hunted down, then call this mega-corporation. The Selection Firm licenses some 900,000 bounty hunters. Hiring fees depend on the Class of Bounty Hunter desired, but ranges from 50,000cr and up.

## THE BLACK MARKET

One can purchase just about anything on the Black Market. The cost depends on the item sought. Most black market items cost three times the retail cost. Items such as nuclear weapons cost 5-10 times the going rate. Characters can also fence goods through the Black Market. The Black Market is an underground enterprise, keeping close ties to the Rebels who obtain much of their equipment there.

Black Marketeers are Deadly. They will cut your heart out and stuff it up your @\$% in a second! Therefore, I don't suggest you try playing Con Man or some other foolish game with them.

## SURVIVAL IN THE CITY

*I look up; the gentle wind rustles through my hair. A vigilant sun slides lazily across my soft blue expanse. He is the forever roaming guardian who wanders toward the horizon, abandons the world for awhile, only to faithfully return the next day. Giant silver monoliths stretch upwards like hungry plants yearning to feel the heat of the sun. A silver butterfly peaks his head above the towering structures and races off to somewhere. Somewhere? It must surely be going somewhere. The rider steered it off behind a monolith, a building somewhere. Insects scramble across the cold, black ground. They move with such an angry purpose, crawling on top of one another. The endless crawling. The butterflies screech by, yet never seek to injure the little bugs. The little bugs scurry off toward sanctuary, one of the monoliths. Sanctuary is inside a monolith. Sanctuary is somewhere. A long, sinuous, metallic snake rears its ugly head out of a hole, then races along across the ground. Across the ground it slithers. The bugs never get near it. The snake screeches. No, not like the butterfly. Louder. Then down it goes, burrowing into another hole. A hole that goes somewhere. Everything races. Races! Screeching to go somewhere.*

Zen Mitil of the Second Tower of Power

## CITY TYPES

The cities of the future are magnificent castles built of glass and steel. They sparkle with the intense fervor of life and represent the mecca of civilization. These metal goliaths house a myriad of different subcultures. They are a prison for the poor and a playground for the rich. The 23rd Century city is the epitome of technological achievement. Yet it also bleeds with the festering morass of spiritual decadence. The futuristic city is in fact, a paradox of beauty and desolation.

There are four basic types of futuristic cities; ground cities, cloud cities, starbases, and base stations. The ground cities grow like tall trees. Gone are the sprawling edifices that once stretched over huge expanses. This design has been replaced by towering spires that reach heights of more than 1000m, massive columned structures linked to each other by pedestrian walkways that hang like ropes in the sky. The walkways are suspended corridors, crisscrossing over each other at dizzying heights. Furthermore, all skyscrapers have grav-landing parking lots on their roofs. The roots of the future city reach deep into the bowels of the earth. They grow as deep as they do tall. Great mechanical robots burrow effortlessly in the sub-basements, excavating space for new occupation.

A typical city has anywhere from 100-300 stories below ground. Down here, there are apartments, factories, malls, and every other normal city attribute. Be careful. One can easily get lost down here.

The next type of metropolitan dwelling common to the 23rd Century is the Cloud City. Cloud cities are small, elegant structures, built on inertia-grav platforms. These cities represent the upper crust of civilization. They are lavishly furnished with riches appropriated from the masses. Cloud cities are inhabited by the rich and established, those who can afford to escape the barbaric conditions of the ground cities below. The mega-corporations build their offices here, far above the cess pool of humanity. Cloud cities attempt to severely restrict the entrance of outsiders by levying huge immigration taxes on anyone entering their private domains.

Orbiting almost all Tech Level 4 and higher planets are space stations called starbases. Starbases are large military platforms that serve as fueling and repair stations for freighters and the great Galactic warships. Their populace is predominately composed of scientists, military personnel, and salvage crews. Starbases are the launching point for all types of deep space travel. However, tourists enroute to some distant location can secure lodging here. All starbases possess artificial gravity systems and utilize the most sophisticated technology and machinery. A typical starbase contains enough facilities to house 10,000 individuals.

The final type of city is the base station. These small platforms are usually located in the middle of deep space, far from the comforts of the Core Worlds. They possess a limited capacity to house personnel, typically around 500. Base stations are designed to carry out military and scientific operations or act as repair facilities. Base stations are so isolated that they are only resupplied every six months. Crew changes are made every year, with most of the inhabitants fighting the war against isolation induced depression. Base stations do not encourage outside visitors. Characters may only dock at base stations under extreme circumstances.

## SPACEPORTS

When one lands at any Alliance controlled installation, city or base he must land at the spaceport. You can try to beat the police cruiser, but that's another story altogether. Spacecraft with landing clearance are locked onto by a gravitational track system and brought to the planet surface. Spaceports exist as a regulating force that control the influx of personnel onto and off the planet. They utilize sophisticated electronic equipment and military personnel to control all activities. Most spaceports possess excellent sleeping accommodations, dining, and recreational facilities. The vast communications network is at the disposal of the visiting traveler. Spaceport personnel are polite and always attempt to aid any individual to the best of their ability. Galactic Law is followed to the letter at all spaceports.

When a person first enters a spaceport, he must pass through quarantine. Afterward, he must get through Customs. All weapons must either be checked in or be taxed before they are brought on planet. Many



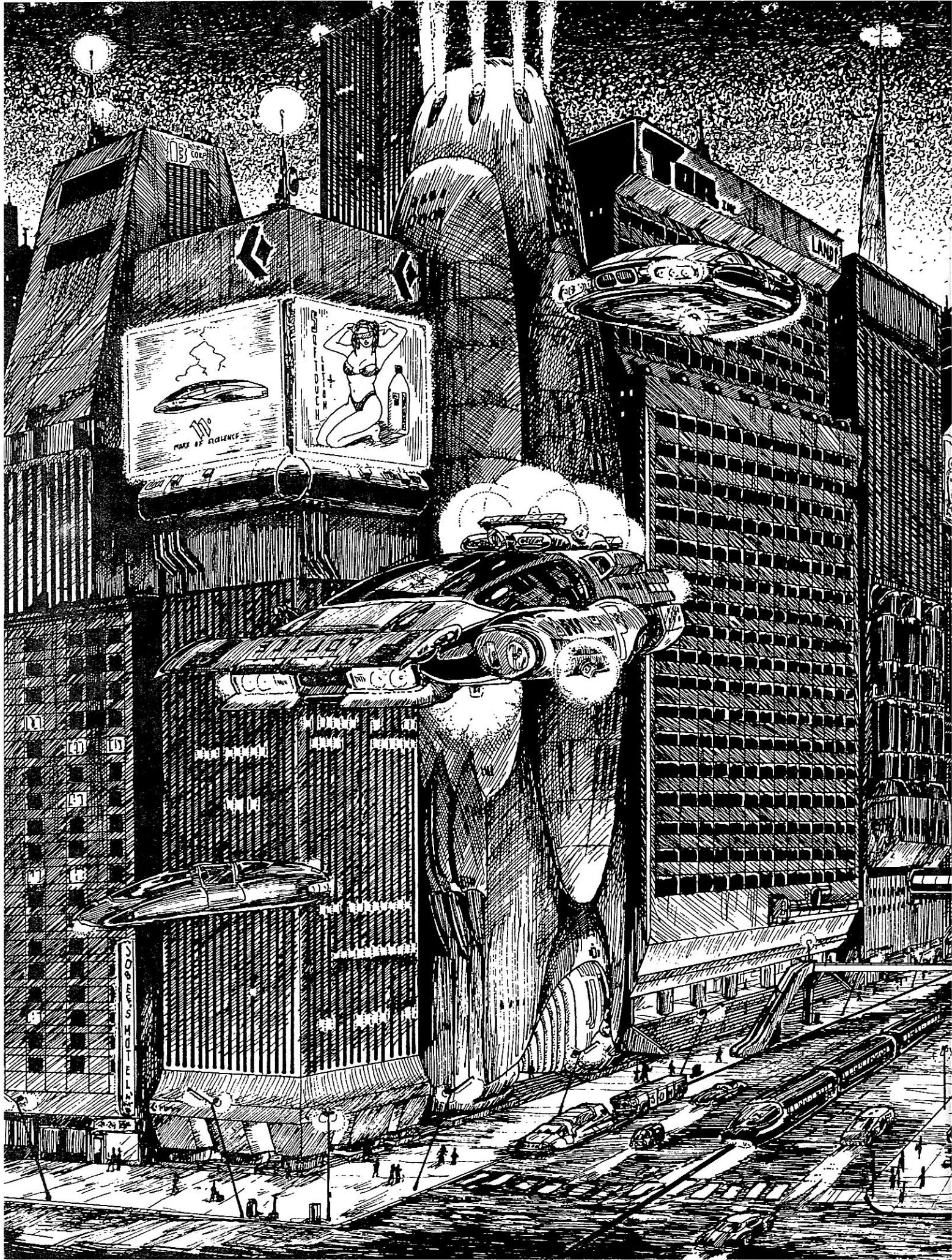

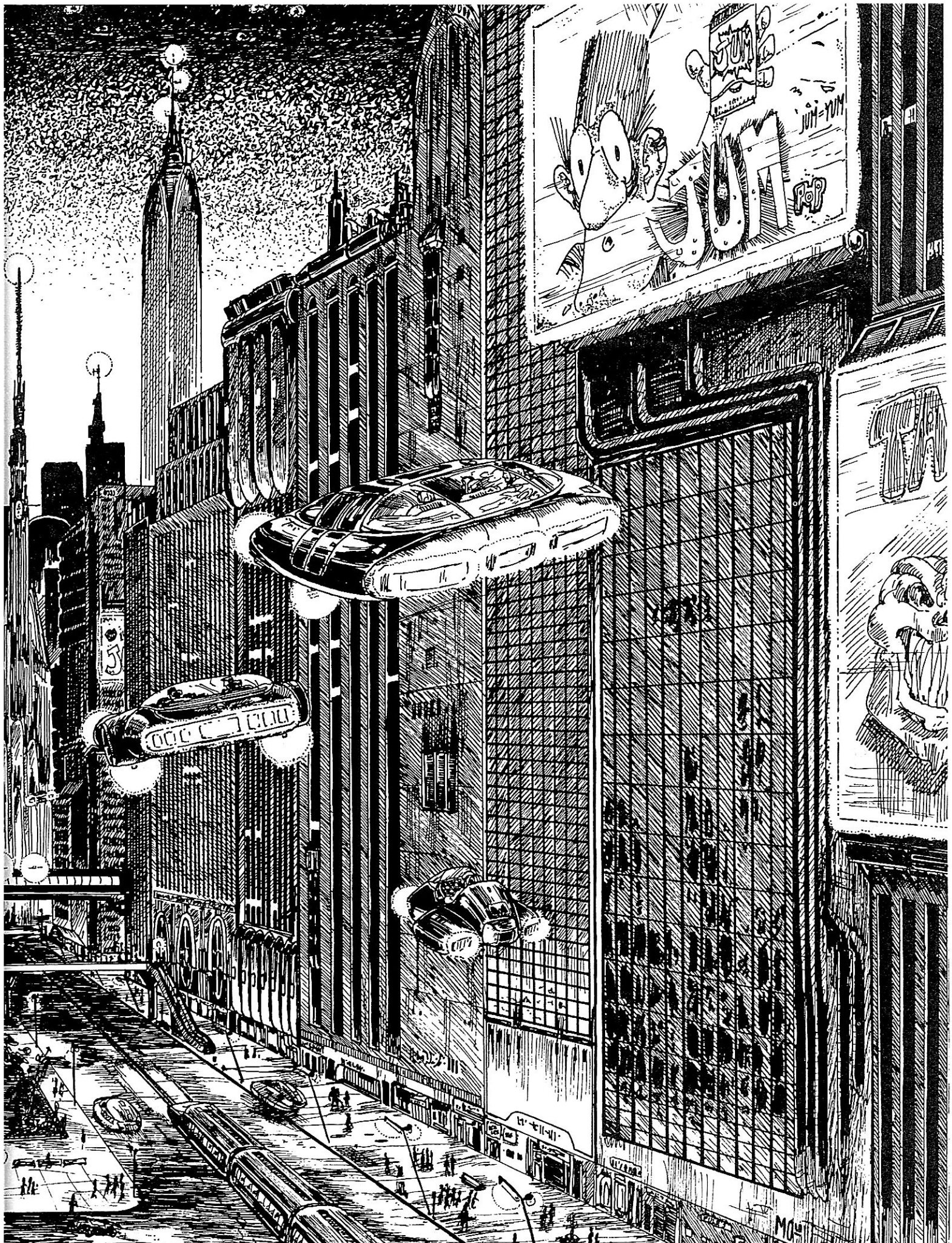

a foolish individual has tried to smuggle weapons or drugs past Customs, only to wind up doing time in New Leavenworth Prison. It isn't suggested that one try to sneak past Customs, yet some enterprising individuals manage to. Bribes are a common method of getting something past Customs.

## BUILDINGS

The futuristic buildings are engineering feats of unlimited proportions. They are vastly complex and yet quite "user friendly". Most wants and desires are provided for. Buildings are well protected against illegal intrusions. The most elaborate structures use the state of the art in security systems to protect their assets. Cameras, motion trackers, and thermal imagers are all used. In crowded places, stunners are placed in the ceiling to control problems on the floor.

It isn't always easy to detect the presence of security systems. Some are conspicuously placed to act as a deterrent. Others are well hidden. Don't get me wrong. You can still break into a building if you are determined enough.

## ZONES OF CONTROL

Most cities are not fond of having para-military psycho-killers like you wandering around their quiet peaceful town. The problems associated with letting you guys loose are obvious. First of all, the police don't want to have to deal with you. Unless you're on a Tech level 4 or higher planet, there is a fair chance that you guys are better armed than they are. The next problem of letting combat types loose in the city is that you tend to frighten people like Betty the house wife, who has only seen 'your kind' on Tri-V. Honest taxpayers shouldn't have to be exposed to hoodlums, such as yourself. So what to do about it? Simple! The police have set up city ordinances governing the areas and times where persons can wear armor or carry weapons. Prohibited areas are well posted and transgressions WILL result in imprisonment, or maybe a good shoot out! Be careful because the cops aren't playing on this one.

## THE RIGHT TO SAY NO

A business proprietor has the right to not let a person into his place of establishment under the following circumstances. One: the individual isn't dressed properly. Two: the person is bearing arms. Three: the person is acting belligerent. These rights are reserved for any owner. He can evict anyone who doesn't fit the specified criteria. Many a proprietor has evicted someone for illegitimate reasons though. It is incumbent on the accused to prove discrimination. This can be extremely difficult. The Phentari and the Chatilians are often discriminated against when frequenting public establishments. Most Phentari have an interesting philosophy about this type of problem. "He isn't laser proof so I might as well blow his head off."

Most upper class establishments enforce these types of rules. A typical bar might just require that the individual agree to a search and electronic scan before entering. The majority of places only enforce the 'no weapons policy'.

## POLICE ACTIVITIES

It is a nasty job, but some Python has got to do it. The futuristic police carry out the same routines as their 20th Century counterparts. They investigate crimes, protect the people, and of course direct traffic. The futuristic police forces have a wide variety of problems to deal with and employ the most sophisticated equipment to tackle them. Most metropolitan police forces use robots to facilitate their work. They field two basic types, Secure-bots and I-bots. Secure-bots possess artificial intelligence and are capable of making a multitude of crisis decisions. They are smart, uncaring, and ruthless. Secure-bots are built on tough combat chassis and carry a variety of weapon systems and detection devices. Some models are capable of flight.

The second type of robot used as an integral part of the police force

is the I-bot. I-bot stands for investigation robot. It is an android programmed with advanced mathematical and science functions, holding a memory storage capacity in excess of 25-50 gigabytes. I-bots look just like ordinary people and are deployed among the masses. They possess artificial personalities with Magna Enhanced 4 speech coils. There is no way to tell an I-bot from an ordinary being, short of a medical examination or electronic analysis.

## GALACTIC LAW

All persons operating within the space of the Galactic Alliance are subject to punishment under Galactic Law. The provisions for said transgressions vary from fines to the Death Penalty. Individuals who travel outside the Alliance territories are subject to the laws of the prevailing culture that they encounter. Under certain circumstances, characters may be imprisoned or punished for unjust reasons while under the law of another culture. (Not that they would ever be treated unjustly by their own present government!!!) The Galactic Alliance can institute extradition papers to return the accused to a Galactic Court of Law where they will be tried for the crime for which they have been previously indicted. This process can take a long period of time. Sometimes it is impossible. It depends on the political relations between the outside government and the Alliance. Below are listed some of the crimes punishable under Galactic Law and the punishments that can be meted out.

1. Theft: Section 48.3 of the Penal Code. The unlawful removal of another's property without consent. Value is less than 1000cr. Fines of up to 10,000cr and incarceration of 1-5 years.

2. Loans: Section 35.1 of the Penal Code. Failure to repay loans due to default or neglect can result in fines up to 100,000cr and/or incarceration of 1-20 years in prison.

3. Contractual Breach: Section 109.4 of the Penal Code. The premeditated breach of a lawfully binding contract between any corporation and the accused. Conviction carries 1-20 years.

4. Default (credit cards): Section 32.5C of the Penal Code. Failure to repay money owed to creditors through neglect or other reasons. 1-20 years imprisonment.

5. Grand Larceny: Section 48.31 of the Penal Code. The unlawful removal of another's property without consent. More than 1000cr value. Fines of up to 100,000cr and/or 3-15 years imprisonment.

6. Robbery: Section 78.2 of the Penal Code. The unlawful removal of another's property by intimidation or violence. Fines, not to exceed 50,000cr. 5-25 years imprisonment.

7. Transportation of Contraband: Section 125.6B of the Penal Code. The unlawful transport of unregulated or illegal materials across Galactic space. 2-25 years imprisonment.

8. Armed Robbery: Section 78.5 of the Penal Code. The unlawful removal of another's property while armed with a weapon. Fines, not to exceed 100,000cr and 7-50 years imprisonment.

9. Assault of a Galactic Official: Section 112 of the Penal Code. Mandatory imprisonment from 10-50 years.

10. Extortion: Section 55.2A of the Penal Code. The wrongful taking of another's money by the use of threat of violence or "color" of office. 7-50 years.

11. Spacejacking: Section 107 of the Penal Code. The unlawful apprehension of a space vessel or its cargo, by force or coercion. Conviction carries a mandatory 15 years to life imprisonment, without chance of parole until the 10th year.

12. Kidnapping: Section 106 of the Penal Code. The abduction of an individual by force or fraud, especially for use as hostage to extract ransom. Conviction carries a minimum of 5 years to life imprisonment.

13. Murder: Section 5 of the Penal Code. The unlawful premeditated taking of an individual's life. (This doesn't include Duels, which are sanctioned events). Mandatory imprisonment for 10 years to life.

14. Rape: Section 56.4 of the Penal Code. The act of physically forcing an individual to have sex. Conviction carries the Death Penalty. (The future society considers rape to be a far worse crime than murder).

15. Desertion: Section 101.A of the Penal Code. The abandoning of one's galactic military obligation, without the intent of returning. Conviction carries the Death Penalty.

16. Espionage: Section 23 The unlawful practice of spying on others. 5-25 years for corporate spy activities. Government spying: Conviction carries the Death Penalty.

17. Subversion: Section 211.2 of the Penal Code. Any attempt to overthrow or cause destruction of the established and legally constituted Galactic government. Conviction carries the Death Penalty.

19. Treason: Section 12 of the Penal Code. The violation of a subject's allegiance to the sovereign body of the Galactic Alliance. Conviction carries the Death Penalty.

20. Murder of a Government Official: Section 69 of the Penal Code. The unlawful premeditated taking of the life of any government official. Conviction carries the Death Penalty.

21. Possession of Nuclear Weapons: Section 23.1 of the Penal Code. The possession of any nuclear device. Conviction carries the Death Penalty.

## MONEY

Most folks don't use monetary currency. It simply isn't practical. All Tech Level 4 planets and above have forsaken cash for cash chits and credit cards. All monetary transactions are dealt with in terms of these cards. Characters can obtain a credit card at any Interstellar Trust Bank, Galactic Bank, or at any spaceport. The credit card is voice activated and utilizes the ancient concept of a p.i.n. number (a secret number) to prevent fraudulent use. Keeping this number a secret is important, since this is the only way to be protected from having someone else use his or her card.

High Tech societies also use the currency chit. These rectangular pieces of plastic are essentially cashier's checks encoded on small magnetic chips. The character need only go to a bank or teller machine and transfer funds to or from the chit. This allows him to hold large amounts of unmarked currency on his person. Cash chits are very popular. One can dispense cash at will, without the government being able to trace it. (Many persons feel the Government already wields too much power and control as it is.) Cash chits are used on Tech level 3 planets or higher.

Tech level 2 societies still use that archaic stuff called money. Characters travelling to Tech level 2 planets can obtain the proper currency upon landing at the spaceport. Money can be transferred to and from credit cards or currency chits. But why you would want this is beyond me.

Tech Level 1 societies use the barter system of trade. The proper currency is whatever object the society considers valuable. Credit cards and chits are useless here, unless one can use credits to obtain valuable commodities first before attempting to barter.

## COST OF LIVING

The following table gives the cost of living for people living on a Tech level 4 planet in the 23rd Century. The prices may vary up to 600%, depending on the availability of the item. For example, the cost for a two bedroom apartment on Terra may run as high as 1200cr. It is impossible to give an accurate cost for most items, seeing that what something costs depends entirely on the planet that you're on. It is the author's opinion that any attempt to list the price of every common item on every different tech level planet would be absurd and limiting. Below are listed some of the basic common items. Remember that something that is of value on my planet may not be worth "squat" on yours.

## TEMPORARY LODGING

Characters will undoubtedly have need for temporary lodging from time to time. They can find it in most cities, at all spaceports, base stations, battle stations, starbases, and stargates. The cost of lodging depends on the quality and location of the accommodations. Satels, motels, and hotels are rated according to a set of prescribed guidelines (Satels are hotels in deep space). They earn up to a five star rating for comfort.

**1-star:** Establishment is the most basic of housing facilities. It has a marginal Health Acceptability, no decontamination, Robo-security, or defense perimeter. Shabby; It's for you bum types. Normally located in the seedier sections of town. Cost: 300cr per week.

**2-star:** Clean and frugal accommodations. Generic arrangements. Most possess a low grade screen for perimeter defense. No Robo-security. Cost: 500cr per week.

**3-star:** Comfortable. Some luxuries available. Exercise units, deep space communications network, decontamination units, vehicle rentals, and maintenance facilities. Found at base stations, battle stations, and ground metropolis. Cost: 700cr per week.

**4-star:** Exclusive accommodations. A full range of extras, including gambling, servant trade, investment, and legal counsel. Contains a Med Center. Full security measures included. Cost: 2000cr per week.

**5-star:** The most opulent of the Temporary Lodging units. Suite and floor rentals. Optional extras and security measures included upon request. Lavish recreational and physical treatment. Personal valets. Interplanetary shuttles, holographic image centers, malls, and more. Cost: 5000cr+ per week for average lodging; Deluxe Suite 25,000cr+. No day rentals.

**OSA:** OSA are the most affordable of all the temporary living arrangements, designed to provide services for overnight guests only. OSA (Overnight Sleep Accommodations) provide the traveler with a Sleep Tube and storage space for traveling bags. The Tube, as it is called, is a thermo controlled, grav adjusting, atmospheric contained, sleeping quarter about the size of an ordinary bed. The weary traveler merely opens the drawer to his assigned Tube and slips into it. A control board allows him to lock the tube and adjust the bed to his comfort. The Tube is equipped with an intercom system, Allo Star lamps, a clock, bullet proof glass, and more. Tube Service can also be provided upon request. Cost: Only 8 credits a night!!!

**NOTE:** Price may increase as a result of location, generally double on orbiting stations, and triple on Core Worlds and Stargates. This effect is cumulative.

## PERMANENT LODGING

Characters may opt to obtain more permanent living arrangements. Apartments are available at most "built up" areas. The cost is dependent on the location and demand.

1. HOUSING RENTAL (monthly)	COST
Efficiency	125
Single	150
Two Bedroom	350
Three Bedroom	500
Four Bedroom	700

	COST	ITEM	COST
<b>2. PERMANENT HOUSING</b>			
Cardboard Hut	Free	Paus Orion (6.2%)	10
Two Bedroom	70,000	Gordan Malt Liquor (11.5%)	5
Three Bedroom	85,000	Femalor Beer (8.2%)	3
Four Bedroom	100,000	Liqueur (shot)	
Five Bedroom	125,000	Oozmo (25%)	2
		Bozage (27.5%)	4
<b>3. HOUSING RENTAL EXTRAS</b>	<b>COST</b>	Dantim (20%)	6
Grav-Landing Pad	1000	Mdbtuognso (28%)	12
Subbasement Parking	100	Liquor (glass)	
Security	250-2000	Quba Rum (40%)	2
Companionship Services	2000+	Dortanmil (50%)	4
Holo-Rooms	500	Chatilian Vodka (50%)	4
		Havenshar Whiskey (50%)	6
<b>4. HOTEL ACCOMMODATIONS (per week)</b>	<b>COST</b>	Nectar of the Ram (75%)	7
Slumming	125	Orion Star Utaban Scotch (50%)	6
1 Star	300	Exotic (shot)	
2 Star	500	Malpi (aphrodisiac)	15
3 Star	700	Bendri (hallucinatory)	25
4 Star	2000		
5 Star	5000	<b>10. AUTOMOBILE</b>	<b>COST</b>
OSA	56	Sedan	8000
Spaceport, Orbital Station	x2	Coupe	6000
Stargate, Core World	x3	Sports	12,000
		Jeep/Blazer	9000
<b>5. CLOTHING</b>	<b>COST</b>	Van	15,000
Clothes (plain)	70		
Clothes (fancy)	200	<b>11. MISCELLANEOUS</b>	<b>COST</b>
Clothes (business)	350	Computer (portable)	3500
Briefcase	40	Computer (hand)	6000
Luggage	100	Computer (desktop)	2000
Combat Fatigues	30	Tri-V	1000
Jungle Fatigues	35	Remote Phone Unit	200
Combat Boots	25	Vehicle Phone	400
Jump Boots	32	Isolation Tank	15,000
Hiking Boots	45	Satellite Link (portable)	10,000
Electronic Ear Muffs	40	Interstellar Satellite Link	240,000
Thermals	50	Vital Statistics Transmitter	20,000
Skin Suits	200	Computer Audio Link	4000
Gloves	20	Automatic Food Synthesizer	10,000
Rain Gear	40	Fax Machine (portable)	5000
Winter Coat	80	Visual Comm Net (portable)	15,000
		CPR Unit (portable)	10,000
<b>6. TRANSPORTATION</b>	<b>COST</b>	Subliminal Information Implant	20,000
Sky Tram (per 20km)	10	Cybernetic Sally (she does it all)	250,000
Metro (day pass)	4	Octaphonic Phase Sound System	10,000
Taxi (per km)	2	Document Atomizer	3500
Plane (per 100km)	20	Police Scanner	100
Car Rental (per day)	50	Energy Supply 5000 units (portable)	1000
Base Shuttle Service	50	Generator (portable)	150
Intra-system	200-700	Weight Set (200kg)	250
Interstellar	1500-10,000		
Stargate	50,000		
<b>7. FOOD</b>	<b>COST</b>		
Meal (restaurant)	10		
Food (per week)	25		
Rations (2wk)	35		
<b>8. ENTERTAINMENT</b>	<b>COST</b>		
Movie	5		
Theater	25		
Cyball	15		
Nightclub (door cover)	4		
<b>9. BAR SCENE</b>	<b>COST</b>		
Beer (liter)			
Algerian Draft (5%)	3		
Kalers (2.3%)	2		
Orionus Supreme (8.5%)	4		

## THE GALACTIC GROCERY STORE

Characters should purchase groceries at least once a month. The average humanoid consumes about 25cr worth of food a week, thrice that cost for the Phentari and Cizerack races. Pythons pay five times as much as a normal human being. Most localities have their own planetary food chains. All space-based food distributors are subsidiaries of the Galactic Grocery Company. All stores are open around the clock, so hungry characters can trot down to one and get something to eat.

The grocery chain utilizes the best in food service. No longer is food stored on shelves or in freezers. It is kept in environmentally sanitized protection banks. One merely walks up and down the aisles. Three dimensional holographic food images line the displays. The person plugs his cash card in the receptacle slot and punches in the quantity of the item desired. Characters may choose as many different items as his credit allowance permits. The main computer tabulates the amount owed and instructs retrieve-bots to get the food. The buyer merely goes to the check-out counter when he is finished shopping. The food is usually there before he is.

## FOOD FOR THE PALATE

What appeals to you doesn't necessarily appeal to me, nor will it appeal to Fredd the Python, if you try to serve it to him, well.... (I don't suggest it if you value your life.) Each of the Twelve Races of the Forge has different palates. Could any human imagine eating a staple diet of worms and grubs? Well, to a Python lizard this is heavenly!!! He sure wouldn't eat anything as repulsive as ice cream. Below are listed the favorite dishes of each of the Twelve Races of the Forge.

### CHATILIAN

**Garsh:** Brain sauteed in butter. Add a little orange spice and ginger root. Serve steaming hot. This is the only meat that Chatilians ever eat and it is considered the finest of delicacies.

**Rougem Plant:** A tasty root that is served as a sandwich with a spicy Eglano sauce.

### CIZERACK

**Blougue Rat:** A 1m long, gray-white rat, indigenous to the planet Cashoulis. Best served fresh and unskinned. The fur has a sweet, musty taste.

**Antarean Sheep's Milk:** This milk is rare and very expensive, but well worth the price.

### ERIDANI

**Kyume:** A meat/vegetable dish. Kyume tastes vaguely similar to the ancient Earth Oriental Stir Fry dish. A few Humans actually like it.

**Tagein:** A large fish, indigenous to the planet Eridine. Tagein are normally broiled and served with Orionus style potatoes.

### GEN-HUMAN and HUMAN

**Beef:** Served in any of a hundred different ways.

**Blue Shenil:** This fish is raised in the Mediterranean fish hatcheries. It tastes like a cross between flounder and crab meat.

### MAZIAN

Any small living organism that happens to be around when it slithers over it. Mazians prefer the texture of things rather than the taste.

### MUTZACHAN

**Sirim:** Small lizard, indigenous to the planet Trishmag. Sirim tastes similar to Earth chicken, but sweeter.

**Caril Juice:** Taken from the Caril tree. This juice tastes like raspberries.

**Radioactive Minerals:** Mutzachans also supplement their diet with mildly radioactive substances such as Uranium-238.

Needless to say, most other races don't like to be too close to an eating Mutzachan.

### ORION ROGUES

**Steak:** The Orion have a penchant for this ancient, rare Earth dish. The steak is broiled and served with Dorium onions and a slice of tasty Black Crus Bread.

**Marrek:** A small, green lizard, imported from the planet Rah. Served piping hot with Boluigue.

### PHENTARI

**Tof:** This plant can only be found in the ice caves of the planet Uranus in the Sol system. It is a delicacy.

**Human:** The Phentari prefer the taste of meat and this dish is a rare delicacy to the most uneducated consumers. It can be served in over thirty sumptuous ways!! A good way to score some dinner is to challenge a human to a Duel.

### PYTHON LIZARD

**Grop:** Worms and algae. The worms are 1/4m in length and should be alive and fresh when served.

**Chakani:** This deep sea fish from the planet Pythos has been exported to other planets. It is served raw with Bag algae.

### RAM PYTHON

**Vatzig:** This large, horned lizard is imported from the planet, Quatran. The lizard is normally let loose. The Pythons chase it down and kill it, making the meal that much more tasteful.

**Agar:** Blood and Mangar curry, jelled in the refrigerator. Agar is chilled until the blood coagulates.

### ZEN RIGELN

**Kish:** This delicacy is a rare plant found in the deserts of the Zen home world.

**Orgisn:** Fresh vegetable dish, similar to Orion salads. It is a delicacy to the Zen.

## PETS

Most races keep small creatures as pets. The exceptions are the Mazians, Phentari, and Zen Rigel. The Mazians generally see no reason for them, unless of course they happen to be edible. The Zen Rigel see it as a crime to hold living things captives, even under the guise of caring for them. The Phentari take the opposite view. Most Phentari hold "little things" in contempt. A Phentari would more likely buy an animal for target practice than for anything resembling companionship.

### CHATILIAN

**Kalukie:** A huge, six legged creature with bright green eyes, a shaggy mane, and a passive disposition. The Chatilians ride these intelligent animals and hold them in the highest regard. Many are able to communicate with their Kalukie. The Kalukie has a natural body threshold of 3 points. Body Points: 2-12x10. Cost: 50,000cr.

### CIZERACK

**Bulie Bird:** It is odd that felines would keep such an animal as a pet. They only keep the females. Male Bulie birds usually end up in the Cizerack's stomach as a snack. The Cizerack often use these birds as scouts or homing devices. Body points: 1. Cost: 1500cr.

### ERIDANI

**Punta Bear:** This great beast was once a fierce adversary of the Eridani. The ferocious Punta is strong and can kill the average individual in a single hand to hand melee segment. It strikes with it's sharp claws and powerful bite, doing 1-3/1-3/1-4 points of damage. Body Points: 2-12. Cost: 3000+cr.

### Gen-HumanS AND HUMANS

**Cats:** The only loved domestic animal left from the 20th Century. All the birds and fish were destroyed during the nuclear holocaust. Dogs were killed off by a mysterious plague in 2080. Most cats serve only as pets. They have no combat value. There is, however, one particular breed of genetically engineered cat that possess intelligence, the Siamese Blue. This cat has crystal clear blue eyes, hence its name. The cat has an IQ of about 35 so it is as smart as the average Python. The Blue is normally used to warn a sleeping human of someone's approach. The cat has excellent hearing and eyesight. Body points: 1-2. Cost: 750cr.

### MUTZACHAN

**Viggit:** These huge, ugly, turtle-like creatures have powerful jaws and razor sharp teeth. They are able to eat through rock at a rate of 5m per day. Viggits only fight if cornered. Otherwise, they flee. They have an exceptionally tough hide which gives them a natural threshold of 2 points. The bite of a Viggit does 1-4 points of REAL damage. Body Points: 1-6. Cost: 500cr.

We All Live in a Yellow Bohemian - Class Star Cruiser

I Love imo

CONFUSIOUS ~~SAY~~

MAN WHO THROWS PLASMA GRENADE IN ARMOURY

IS TOTAL MORON

Wash softly and a BIG Bah Pyth

KNOCK KNOCK

who's there?

JIM JONES

AND THE

BAD BOYS FROM GUYANA

CLONE TO BE SEED!

PLASMA

PLASMA

UNCLE PLAYS THE NEW PALLADIUM

JUNE 21, 2000

IN THE COLD, BLEAK EXPANSE OF SPACE, WHEN YOUR TORTURED THROAT CURDLES ITS LAST SCREAM, IT WILL ECHO AGAINST THE BLACKNESS OF DEATH AND SURRENDER TO THE VOID OF NOTHINGNESS

SOLID!

C. MARTIN 2074

KNOW

PARSHROM SCIENCE CORPORATION: THE TECHNOLOGY OF TOMORROW, KILLING PEOPLE TODAY!!!

Famous Mutzachar Quote "I've fallen and I don't want to get up"

COMMENTING

The only way to validate one's existence is to do good to others. It is easy to live selfishly. It takes strength to care.

-Foto - '64

THIS IS MY PLACE.  
THIS IS YOUR PLACE?  
QUESTIONS?

WAX 'EM-N-

PHENTARI CHAINSAW MASSACRE 47+  
NOW SHOWING AT A HOLO-ROOM  
NEAR YOU.  
DON'T MISS IT!  
(OR ELSE)

LIVE WITH DIGNITY

DOES IT  
CIDER  
FAX 'EM

KILL WITH HONOR

Peace is a Bastard's profession  
Mass-murder is just a hobby  
-Mullhaus Durbhart

PLASMA HIT

LIVE IN THE FRONTIER

Top Slavery in the New Colonies  
-Queen Cho. 2265  
WILLEM ALL

WHAT ARE YOU?  
COMMUNIST  
Peace  
Love  
And

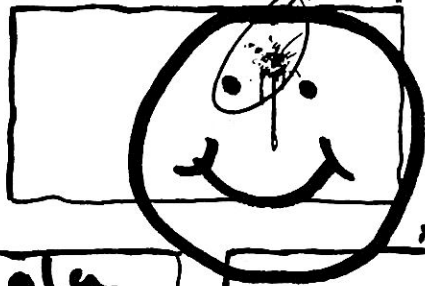

LIVE IN THE FRONTIER

No BUT I like  
the Death

Granola

AND DIE IN SHALLOW GRAYES



Human is on sale  
for \$12.99 a pound  
at your local  
Deli

ON THE EDGE

REBELS RULE?  
OH SHUT UP!



ON THE MOON.

PINHEAD!

That a Meg found  
you just happened in your pocket to see mine?  
It's an Omega Cannon and  
blow your head off!

FOR A GOOD TIME CALL  
JACQUASARTIS

900-555-4444

WATCH OUT FOR NICOTINE  
FITS ON METANE  
PLANETS

Death  
to all  
Aventar

VALET  
PARKING

Dak Avalon  
What we  
an you

I KNOW IT FEELS GOOD  
BUT BATTERIES ARENT  
INCLUDED

Erldasi GEEK!

ELVIS IS DEAD  
AND I KILLED HIM!

ELVIS IS ALIVE  
AND LIVING ON MULLIGAN'S PLANET

Elvis? Wasn't he the guy elected Earth  
President in 1996?

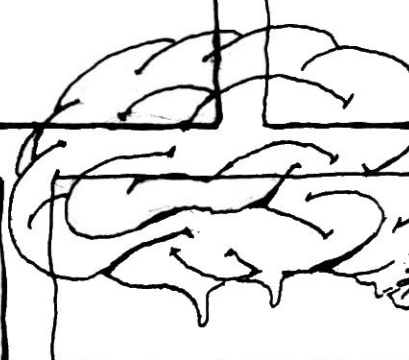

ELVIS? ELVIS WHO?  
I KNOW AN ELVIS WHO  
BUT HE WASN'T FROM  
MULLIGAN'S PLANET AND  
I THINK HE WAS DEAD  
ANYWAY

Improve  
the grade curve  
EAT a

Mellon Head

Elvis Jones  
is the real  
King!

IF A Starship Explodes in Space,  
and there is no one left alive to here it  
will Orions take Shiny things from Ranylytons?

I SURVIVED 7 WEEK  
IN KODIAK COUNTR  
YEA  
RIGHT

LONG LINE  
OF THE FAT, BLACK  
CONDOR!!!

Elmeee

YESTERDAY,  
THE BOUNTY HUNTER SEEMED SO FAR AWAY  
NOW IT LOOKS AS THOUGH I'LL STAY.

OH I BELIEVE IN THE ORION WAY.  
SUDDENLY, THE ROGUE I USED TO BE  
I AM HALF THE PLASMA HOLES INSIDE OF ME  
OH EXCERUATING TRAIN CAME SUDDENLY.

Hey! Have you heard the latest from the Prophet Salamar?  
No, What Now?

CREIGHT  
WASSING  
HERE!

He claims that the Arachnids are merely searching for a new home.  
He says that there is something feeding on them,  
forcing the spiders to flee their own galaxy.  
That is why they are here.  
He also says that the Alliance is on the verge of being destroyed.

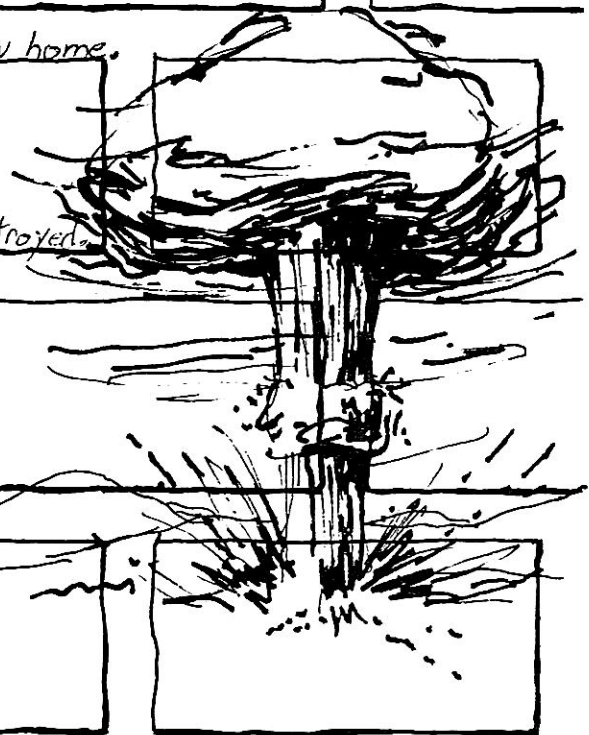

He says that if it weren't for Jaquassarious Phentari,  
Then it would have already happened.  
Jaque is supposed to be working with the Dane,  
to avert the future.

Yeah RIGHT!!  
Salamar who predicted  
that the entire Carina Galaxy  
would be destroyed in 2208!!!!

It was also predicted  
that the entire Carina Galaxy  
would be destroyed in 2208!!!!

THAT GUY IS  
A QUACK!!!

Teledyne buys  
KOBUL in  
daring corporate  
take over

Attention Space Mart Shoppers!  
Blue Light Special in aisle 121  
For the next 10 minutes Tri-Mesh  
will be on sale for 12.99!

### ORION ROGUES

**Furbl:** The Orions keep a cute furry little creature called the Furbl whose description matches its name. It has no combat value, but is nice just the same. Furbls have pick pockets skill at a 3rd level of proficiency. Body points: 1. Cost: 50cr.

### PYTHON LIZARDS

**Cag:** A large turtle with two heads. This water born creature is formidable in its own environment. It swims at great speeds and can deliver a nasty bite with each head. A bite does 1-3 points of damage. If the Cag is taken from water, its skin dries up in a short time and it dies. Body Points: 1-6. Cost: 700cr.

### RAM PYTHON

**Cudda Lizard:** The Ram keeps a large, mean lizard for a pet. Why? Something to wrestle with when they get bored. The lizard is semi-intelligent, with an IQ of 20-30. It attacks with blazing speed; -2 to initiative rolls. The mighty Cudda strikes with its tail as well as its mouth in combat, doing 1-3 and 1-4 points of damage respectively. A Cudda is unquestionably faithful. Body Points: 2-8. Cost: 5000cr.

## THE BAR SCENE

You are going to go out. Come on!!! You're not always gonna be running around killing things. What kind of warrior spends the night inside watching the news. Everything good happens when you're out. You run into just about every type of creature imaginable, and even some unimaginable. Futuristic bars provide a variety of entertainments. Most have a dating service of some kind. Temporary mates can be rented for relatively cheap prices. Certain drugs can also be purchased at the bar, aphrodisiacs being the most common. Characters may or may not have to check their weapons at the door, depending on the bar. The most exciting bars don't do this. Of course these are also the most dangerous establishments. Most bars utilize stunners in the ceiling to terminate problems that may occur on the floor. So be careful when you're out having a good time.

## MADD MIKE'S MERCENARY BROCHURE

Madd Mike's Mercenary Brochure is an interstellar mercenary magazine sold on most civilized planets. The brochure contains a listing of mercenary jobs available throughout the universe. The list provides all the pertinent information concerning the stated job offering, location, qualifications required, rate of pay, along with a detailed job description. Characters may opt to place advertisements in the paper themselves, under "wanted" or "for hire." A one week running of any advertisement, less than 50 words long, costs 30cr. The brochure is sold in most planetary stores and in all Galactic Groceries.

Players often wish to hire out mercenaries for combat missions and accomplish this by consulting Madd Mike's Mercenary Brochure. The magazine can be purchased in every major store. Players should find out as much information about the prospective hireling, for mercenaries tend to be only as loyal as the amount of money that they are paid.

## CYBALL

So you want to be a famous Cyball player. So what! It is the dream of every other adolescent. The fame, the money, and the glory. Cyball is short for Cylinder Ball. It is the number one sport in the four populated galaxies. The 6571 different teams are watched by some 100 billion viewers weekly.

What is it exactly? Cyball is a cross between Earth style lacrosse, rollerball, and football. It is played in a 200m long, 50m diameter cylinder with the idea being to move the 2kg titanium steel ball from one end of the cylinder to the other and place it in your opponent's goal. Players wear magnetic boots that allow them to maneuver freely about the surface. They are governed by rules, some players remaining on the "ceiling of the cylinder" at all times, others riding 300cc motocross vehicles. It is hyper-violent with some 1500 players killed

every year while 35,000 are injured. Currently the Rigel Death Knights are the reigning six year champions, amassing some 23 kills, 6385 goals, and a record of 1129/40/8 over the last 5 years.

## HEROS AND VILLAINS

There are literally hundreds of thousands of them throughout the galaxies. Only the greatest and the most heinous deserve mention and they are given below. Now don't let this Hero stuff go to your head. Sure, you have delusions of grandeur. Dreadnought battle armor, a Crusader laser cannon, a cigar, and all the women you want. You figure it is you who is going to be the rave of the press. More likely, you'll end up face down in some shallow grave on a desolate planet in the middle of nowhere. Don't get caught up in it. If you are good, then it will all come to you in the end.

### Villains

6) **Kaba:** The Renegade Ram Python who is wanted on 1500 different counts of murder, cannibalism, and extortion. He has kidnapped and murdered the beautiful Princess Galena of Dimeron. Reward posted at 10,000,000 credits.

5) **Jerred Makhouse:** The infamous Orion Rogue pirate who is wanted on 4000 counts of murder, 5560 counts of kidnapping, and the theft of some 290 vessels. He has escaped from authorities nine different times and the reward for his capture is posted at 11,000,000 credits.

4) **Sabrina McCloud:** A voluptuous Gen-Human known as "Sexy Sady." Authorities claim that she is responsible for the Great Terran Bank Robberies. Reports estimate that she has made off with more than 250,000,000 in cash and another 320,000,000 in jewelry in some 740 strikes. She has never been arrested for anything. Reward is 23,500,000 credits.

3) **Michael Bernel:** The leader of the Rebel Cause. He is wanted on numerous counts of treason, sedition, terrorism, murder, etc. His followers call him the "Fat Man". Reward: Negotiable.

2) **Uncle Ernie Freiberg:** The only reason that he isn't the most wanted criminal in the galaxies is because there isn't any conclusive proof of his actions. Uncle Ernie is the apparent founder of the Anarchist Rebellion Movement, also known as the ARM. The ARM produces, sells, and trades in hazardous lifeforms. Its intent is to destroy the universe and the Alliance. Ernie is allegedly their leader.

1) **Jaquassarious Phentari:** The most wanted criminal in all the galaxies! He is said to have eaten children and murdered old women just for pleasure. He is reported to have "Nuked" the planet Sharron, killing some 40,000,000 innocent beings because he was bored. His loyal followers call him "Grandfather." He is wanted for some 5000 other counts of murder, kidnapping, and terrorist activities. Reward: As required.

### Heros:

**Sergeant Tobu:** This heroic Ram Python held off an entire company of Rebel Assault Fighters to bid time for the rest of his men to reach safety at the Battle of Willow Wood. He was wounded four times during the battle and in the end, he still led the final assault on the enemy forces. Medals: 3 Purple Hearts, The Bronze Crown (with oak leaf cluster), and the Legion of Honor.

**Zwis Yblo:** Zwis is the most decorated combat medic of all time. He has saved the lives of some 32,000 men in his life, been wounded in action 78 times, and has been MIA another 21 times. Medals: The Chain of the Fallen Warrior, The Talisman of the Faithful, The Temple of the Benevolence, 21 Purple Hearts, and twice has won the Alliance's highest accommodation, The Legion of Honor.

**Vardak Mizzikiatz:** This Mutzachan was awarded the highest civilian award obtainable, the Crest of Freedom. Vardak singlehandedly took on and defeated the Dark Forces on the planet Belise 12. His tremendous efforts helped to save the lives of some 200,000,000 inhabitants.

**General Gar of the Python Republic:** The most decorated combat soldier of all time. He currently is in charge of the Galactic Defense Forces. This stubborn, willful, and tenacious Ram Python still insists on leading his stormtroopers against the Arachnids (always wearing a red scarf and carrying a platinum shield and two handed sword into combat). Gar, alone and wounded, once entered an Arachnid hive and singlehandedly killed 37 of the spiders before he was critically wounded. The General refused to be evacuated from the combat zone, insisting that he remain to lend morale to his troops. Medals include: The Red Cross of Valiantry, Fornax Shield of Courage, Bronze Crown (with oak leaf cluster), The Chain of the Fallen Warrior, 46 purple hearts and an unprecedented 3 Legions of Honor.

**Colonel Ronald Trackey:** Led the heralded "Flight of the Valkyries" against the Arachnids, during the Battle Over the Sea of Orion. His heavy squadron of 18 Viper class fighters, call sign: "Wolverine Squadron," destroyed 4 Arachnid warships before all was finished and damaged 2 others. Historians claim that it was indeed their heroism and unswerving valor that turned the tide of the battle and stopped the Arachnid Invasion of the Galaxies.

Alone, he took on an Invincible Class Arachnid Mauler. Wounded and low on fuel, the colonel flew the suicide run against the enemy's hail of point defense fire and fired his last screaming missile at the vessel's bridge, disabling the giant until the Battleship Valiant could bring her guns to bear. Only six other fighters survived the battle. Medals include: Bronze Crown, The Valkyrene Fighter, and the Legion of Honor.

## THE DUEL

The Duel is a lawful, sanctioned event under Galactic Law. It is considered a just method of combat. Anyone may challenge another to a Duel. The restrictions on such an act are as follows:

1. There must be a minimum of five witnesses, of which there are at least two with no relation to either participant in any capacity.
2. Both parties must agree to the Duel.
3. The terms of the Duel must be announced aloud and agreed upon. A Duel is fought to submission, first blood, injury, or death.
4. Individuals choose and agree upon weapons.
5. No outside intervention is permitted by anyone. This act voids the terms of the Duel and is considered illegal. Such an egregious transgression is punishable by death.
6. Individuals possessing special powers cannot use their abilities in any way to affect the outcome of a Duel, unless agreed upon by both parties. The penalty for such an action is death.
7. Individuals who refuse a Duel are entitled to a 30 hour grace period before being challenged again.

The effect of a Duel is to eliminate enemies or to disgrace individuals. It is a powerful device at the use of any character. It is the author's opinion that players should take some skill proficiency in archaic hand held weapons when creating their characters. Most Duels utilize this type of weaponry.

Things to consider: Don't expect to win a duel against an Eridani. Don't expect to win against a Ram Python. They are almost as deadly as Eridani. If you are a Mazian and are challenging someone to a Duel, then you are either stupid or have a nasty trick up your sleeve. Finally, bet all the money you have on yourself. You won't be worrying about paying your bills if you lose.



## GALACTIC NEWSMEN

They are not like any wimp found on the planet Earth in the 20th Century. These guys play for keeps. They get paid large sums of money to find/make news for the Alliance. Most of them carry a class one bounty hunters license. All Alliance subjects may be questioned by a newsman at anytime. They must cooperate with the reporter. Newsmen will go to almost any length to get the scoop. They have special dispensations protecting them against prosecution. They can jump aboard any Alliance vessel at any time they see fit and go wherever they want. They snoop, snoop, snoop, and many have wound up face down in a puddle for messing with the wrong person. By the way, a Phentari is considered to be the wrong person. Be careful. Many are spies. It helps feed the family you know. The problem with newsmen is that they hang around where the action is. Note: Battlelords constitute action!! Unless you're a Zen Rigeln Geek!!!

## NO NUKES

The possession of any nuclear weapon or technology is punishable by death under Galactic Law. Gen-Humans and Humans control most positions of power in the government. Armageddon almost obliterated the planet Earth during the 21st Century. Russia and the United States of America slipped into a conflict started by the upstart third world nation Libya.

The Soviet Union conducted a first strike against strategic U.S. military installations. NATO retaliated. The electromagnetic pulse generated by the explosion of hundreds of nuclear warheads, prevented a second strike by either of the two nations. Result: A limited exchange. Nuclear Winter followed and 40% of Earth's population was wiped out over the next twenty years.

The Humans and their counterparts abhor the idea of nuclear weapons. They have adopted laws and resolutions to control the production of these devices. Nuclear weapons are only available on the Black Market. They are difficult to obtain, yet can be purchased with the proper contacts.

Nukes? Well they represent the ultimate in the idea of "To Whom it may concern." Just keep them away from Mutzachans.

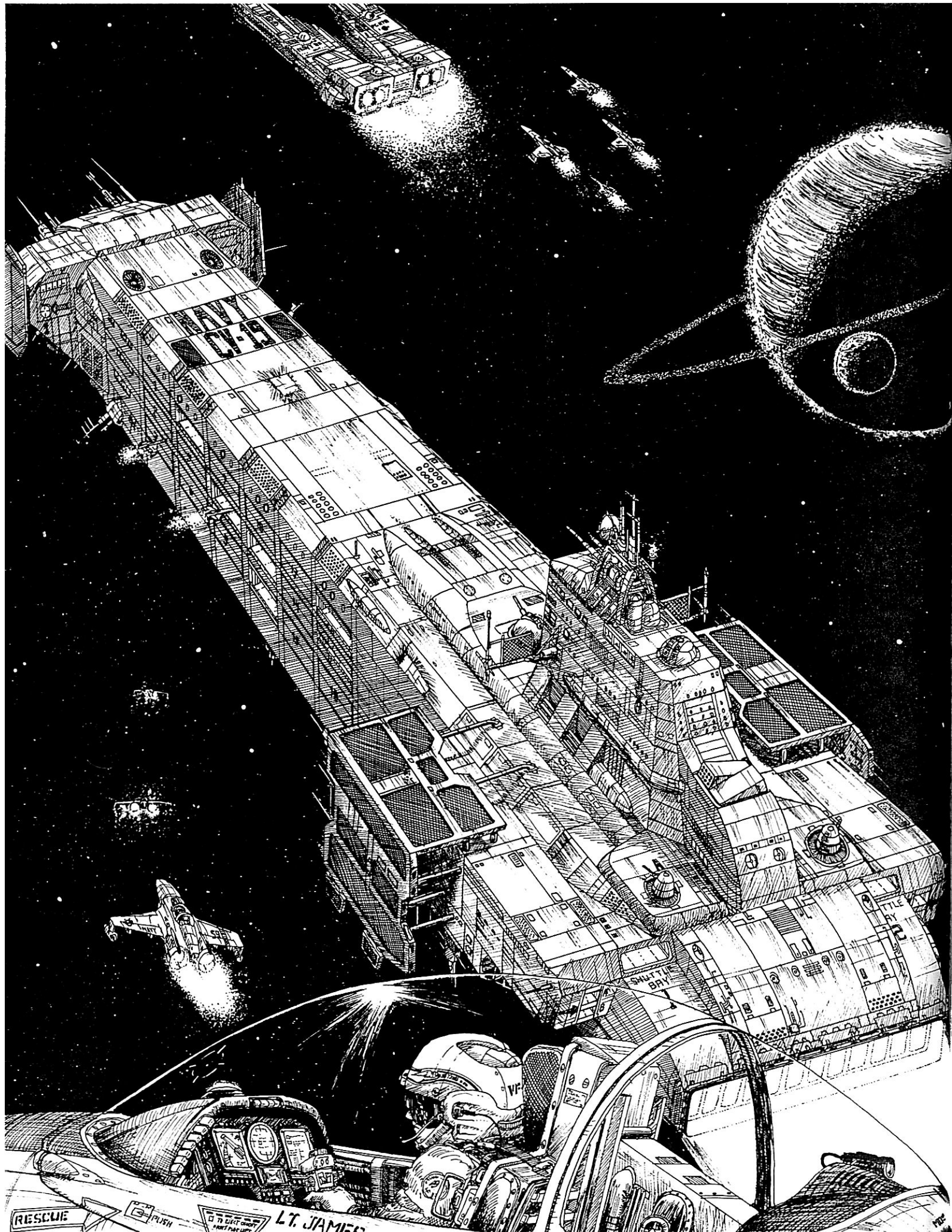

RESCUE G-PUSH L.T. JAMES

L.T. JAMES

## RENT A SKILL

At times your character may have dire need of a certain skill, but doesn't have the time to learn it. This is no problem. Just go to your friendly neighborhood Rent A Skill store. In 2156, scientists linked artificial intelligence to the brain. Rent A Skill is the direct product of such a breakthrough. Rent A Skills are "canned" reflexes, providing instant base level proficiency in a given skill area. A neuro synapse transducer is surgically implanted into the base of the occipital lobe of the recipient. All the information concerning the base knowledge of a given skill is imprinted on a small artificial intelligence microchip. The chip is coupled to the implant which feeds directly into the conscious mind of the recipient. The recipient is automatically bestowed with the ability to perform all tasks imprinted on the chip.

The cost for the basic implant and insertion is 20,000cr. After surgery, the character spends 1-4 weeks in recovery. Once it has been determined that the artificial intelligence implant functions, he is released from the hospital and need only go to any Rent A Skill store to pick up a particular skill chip needed, then insert it into the implant. The character is automatically able to perform the given task requirements designated by the chip purchased. The cost of the microchip depends on the skill required. A Basic Medical Treatment Chip costs as little as 100cr per week, while an Ionization Control chip costs 5000cr per week. Characters must return the chip after the agreed rental period. Failure to return the skill within twice the allotted rental time results in the immediate erasing of the chip program. Failure to return the chip within four times of the agreed rental time results in the implant itself fusing, destroying both chip and implant. The fusion can also cause brain damage. Any attempt to surgically remove the implant without the proper authorization codes causes the implant to fuse together.

Characters may purchase multi-function chips, but this is prohibitively expensive. Due to their biological ability to absorb objects, Mazian characters need not pay for implant surgery. They simply surround the implant and ingest it into the body. Rent-A-Skill, however, charges them twice the normal cost for rented chips. Got to make money!!!

## CLONIC PRODUCTION

Characters can have clones made of themselves, in case they should die, or something worse should befall them. All clones must be registered with the Bureau of Genetic Construction (BGC). The BGC licenses the individual to have copies of his body made for a fee of 5 million credits. The person can then have duplicates made of his mind for 20 million credits and backup memory storage banks for 5 million credits. The body, or shell as it is called is kept in cryogenic storage until the mind needs another home. The person must periodically have his memories "backed up" on an electro/synthetic brain unit at a cost of 25,000cr per visit, otherwise he retains only those memories from his last visit to the Bio Storage Facility (located on Katrel). Any unlicensed reproduction of a shell or mind carries the Death Penalty. The Galactic Bureau of Synthetic Management continually seeks out illegal operations.

## DNA MASKING

DNA masking is an illegal surgical technique used to temporarily hide one's true identity. Fugitives from the Galactic Law are tested for DNA makeup to determine their true identity. The DNA imprint is unique for every person and can not be replicated. Police units simply bring the accused in for a skin sample analysis. The sample contains the DNA print. Some surgeons are willing to temporarily mask the print by grafting a second layer of skin on to the body. They obtain the skin by appropriating the bodies of fresh corpses, which is highly illegal. When the skin graft is taken, it reveals the identity of the dead individual. The accused is freed, since he is obviously innocent. No one keeps track of the 500 billion registered beings.

The cost for the operation is somewhere around 150,000cr. The artificial skin will last for 7 days before it begins to decompose. The

Galactic Police rarely do a biopsy on the muscle tissue. This costs much more than the skin graft and is thus uncommon. A DNA test of the muscle can not be hidden by any known means and a biopsy automatically reveals the true identity of the accused.

## PLASTIC SURGERY

Every once in a great while players may have the urgent need to change their identities. Maybe a dangerous adversary is tracking them, a bounty has been placed on their heads, or the Galactic Police have a warrant out for their arrest. Whatever!!! Characters can go to a plastic surgeon to have their facial features altered. The surgery is expensive, about 10,000cr. Fingerprints can also be changed. This procedure only has a 65% success rate and costs 10,000cr. Plastic surgeons usually refer characters to a voice treatment center where players can have their voices changed. The referral cost is only about 100cr, but the voice alteration surgery costs around 20,000cr. The only thing that can't be changed is a character's DNA print, except as noted above.

## QUARANTINES

Adventurers must be quarantined from time to time. This is done to ensure that deadly viruses or other hazardous life forms are not transmitted to the "clean" populace. Whenever a mission team exits an uncharted planet, they are incarcerated in a Quarantine House. Q Houses are sealed living quarters carried aboard all exploration vessels and most corporate ships. The expeditionaries are tested for contaminants. A positive result indicates that the group must remain quarantined until the contaminants can be secured from the body. On rare occasions there is no way to remove foreign organisms. When this occurs, ship captains are instructed to jettison all "contaminated refuse."

## CUSTOMS

All Alliance personnel are required to pass through customs before landing on any Alliance territory. This statute applies to planetoids, asteroids, base stations, starbases, battle stations, etc. Independent planets have their own mandates concerning passage onto and off their own worlds. Furthermore, in any war zone, personnel are required to carry special operations licenses which allow them to move freely about that zone only. Finally, personnel who have entered the atmosphere of any unexplored world are subject to a multitude of constraints. First, they are automatically incarcerated for a period of no less than one month to insure that they have not brought back any hazardous lifeforms or materials that may in any way jeopardize the safety of the people of the planet that they wish to land on. Second, they are routinely interrogated as to the reasons for setting down on the planet in the first place. Such questioning under Galactic Marshals can take weeks and sometimes months. The Federation Customs Agency is responsible for the regulation of interplanetary commerce. Its responsibilities include the maintenance and safeguarding of sovereign societies, interdiction in illegal trade activities, regulation of intergalactic trade, and the setup of cultural assimilation programs to assist those persons entering a new world. The Federal Customs Agency is a branch of the Galactic Police and comes under its jurisdiction.

## DEFENSE NETS

All Alliance territories are guarded by a variety of defenses to prohibit illegal entrance or departure from the place in question. These interactive defense networks are called the Defense Nets. Violators of the Free Space Constraint Acts are subject to punishment under Galactic Law. Potential criminals should be forewarned: Certain criminal actions invoke the Emergency Response Act which allows officers to respond to violations in any manner that they see fit. In other words, if you screw up real bad, the Alliance will terminate you. Yes! Stealing a space ship and then trying to evade the police in order to avoid capture constitutes a direct violation of Galactic Law. Police cruisers will blow you out of the skies before you ever make the jump to light speed.

Most planets utilize energy sensitive satellites to detect the presence of intruders. These satellites are equipped with heavy weapons to destroy any unauthorized ships who approach within restricted space of the planet's surface. Most pirates utilize cloaking devices to make raids on planets.

Whenever characters move "planetside", they are required to pass through customs. The Customs office is located within the confines of the spaceport. The procedure for entering follows each of these steps:

**Decontamination and Quarantine:** Generally takes from 4-16 hours. Personnel who are found to be hosts of "undesirable assets" will be interred until the foreign substances can be removed from the body. In the event of decontamination failure, personnel must exit the planet immediately. Alternate travel options will be provided if available. Under the unlikely event that there is no place that the infected person may find sanctuary, Customs Agents are instructed to terminate the refuse and dispose of it.

**Baggage Inspection:** All baggage must pass through Customs inspection before it is brought on planet. Customs uses a wide variety of methods to inspect baggage, including X-ray technology, electro-mechanical matter analysis, and of course visual checks. The penalty for smuggling goods depends on the type of materials confiscated. The most typical violators are arrested for smuggling weapons and other advanced technology for sale on the Black Market. The penalty for these infractions range anywhere from 6 months to 25 years imprisonment.

**In processing:** Customs agents create a personnel file, recording all pertinent information. Personnel are fingerprinted and have their arrest records posted. All personnel are issued travel documents of some kind, typically a plastic identification card. Personnel with arrest records or other federal problems have their IDs stamped. Special weapons permits are issued at this time. Galactic bank statements are taken to determine the person's credit history. Individuals with outstanding debts may have their monies appropriately secured, or occasionally face arrest.

**Cultural Assimilation:** Incoming personnel are briefed on the social mores and rules followed by the culture in question. The lecture speaks of the Dos and Don'ts of those people entering the mainstream populace. The disposition of dangerous lifeforms is provided during this part of the induction phase. Finally, the status of prevailing governments is confirmed.

**Entrance into the Culture:** Personnel are provided with transportation to various debarkation points. Living accommodations can be secured along with other necessities like body guards.

## WEAPONS CONTROL

The import of weapons onto any planet is severely restricted. Most Customs Controls allow weapons to be carried, but only with a permit. Any person bringing weapons into a spaceport must pay an import tax. This tax is levied without question. Most planets don't permit weapons technology greater than that of their own culture. Characters should always carry some extra cash to pay for taxes or permits when bringing arms planetside.

The technical development of any colony planet for commercial profit is strictly regulated by the Galactic Development Administration (GDA). The amount and type of technology that can be sold to any particular planet is subject to a multitude of governmental constraints. The Hickerson Report, a controversial document written on the evolution of colony planets, prefaces that all species evolve technically at an accelerated rate compared to their emotional progression when subjected to outside influence. The paper focuses on the progression of those societies who were provided superior technology to advance their civilizations, as opposed to those societies that were left to evolve on their own.

The project scientists concluded that the vast majority of cultures who receive outside interference during their natural evolutionary processes were much more likely to commit genocide within their own species. These cultures were ten times more likely to use the provided technology for the purpose of war and other atrocities.

The GDA sets up the regulations to prevent the exploitation of colony worlds by the mega-corporations. Any attempt to import materials not specifically sanctioned by the Galactic Development Administration, may result in fines or imprisonment. Consequently, many civilizations in the galaxy reap the fruits of technological advancement, while others remain entrenched in the Stone Age.

## SMUGGLING

There are ways to smuggle items on planet. Characters can pay to have their equipment smuggled in. This can be dangerous. It depends on the circumstances, the goods to be smuggled in, and the amount of money that individuals are willing to pay to have their stuff handy! There is always a chance that the goods will be confiscated, due to no fault of the Customs agent. Occasionally, the party faces being set up. It all depends on the situation. Given below are the constraints to smuggling illegal contraband, along with the costs.

The base chance of detection represent the base chance that the particular item will be detected and then confiscated. The cost represents the amount of money that one must pay before a Customs agent attempts to smuggle each item in. Each time has a Tech Level assigned to it. The incremental difference between the item's Tech level and that of the planet dictates how much extra must be paid to smuggle in an item to a planet of a Tech Level below it. Thus if you were smuggling something from a Tech Level 5 Omega Cannon (heavy) onto a Tech Level 2 planet, you would be required to pay  $(3 \times 40,000) = 120,000$ cr. Expensive!!!

Detection = % chance of detection  
 Cost = base cost to attempt smuggling

ITEM	DETECTION	COST
Armor	20	5000
Helmet	07	1000
Grenade	05	1000
Plas Grenade	05	2000
Omegaton Grenade	05	2000
Pistol (archaic)	15	100
Gun/Carbine	10	500
Shotgun	10	500
Machine gun	15	1000
Laser Carbine	10	2000
Laser (heavy)	15	15,000
Impact Lasers	15	35,000
Pulse Cannon	17	7000
Pulse (heavy)	20	30,000
Omega Cannon	20	15,000
Omega Cannon (heavy)	20	40,000
Disintegrator	12	10,000
Disruptor	12	7000
PMS	15	25,000
Metal Gun	10	2500
Energy Weapon	15	3000
Anti-Tank	20	25,000
Mortar	20	3000
Syringe	02	200
Medical (small)	03	50+
Large Medical	05	150+
Misc Items		Determined by the Battle Master.

NOTE!!! Heavy Weapons are those with an encumbrance value greater than 20. Small equals anything of 4 encumbrance or less.

Let us make sure to note that Bargaining skill has a great effect on the cost of the goods to be smuggled. The cost to have any item's smuggling price is determined by as follows: Roll Bargaining check. For each point that you roll below this, the cost to smuggle that particular item is





reduced by 01%. Paying extra money lowers the chance of something being confiscated. Every 10% extra reduces the chance of detection by 03%.

## CREDIT CARDS

Player characters often need to purchase items, but do not have enough cash on hand to do so. One can simply apply for a major credit card at your local spaceport or Interstellar Trust Bank. Credit references expedite the processing of applications which generally takes 2-4 weeks. Characters must be currently employed and have been so for a period of time of no less than six months before obtaining a card. A credit card allows the owner to withdraw needed funds at a moments notice. The card is voiceprint activated to screen against theft. All anyone need do is go to the nearest teller machine to use his card. There is a monthly charge of 10% interest. Payment must be made within three days of the due date. Failure to pay on time may result in the cancellation of the card. Individuals may miss three consecutive payments before the card is voided. Failure to pay the debt within one year results in a warrant put out for one's arrest. Local bounty hunters and police officials shall be notified.

Players can opt to take out up to 500cr at the beginning of the game. There is a 20% monthly interest payment accruable per month. The limit of the card can only be raised once every 6 months. If the card owner has missed one payment in that time, FOR ANY REASON, then the card limit will remain the same. The card is revoked if the person misses 3 consecutive payments, FOR ANY REASON, or misses any five payments in a given year. The bank isn't interested in the fact that you are stranded on some jungle planet facing 200 Arachnids. That is the reason why they charge you so much interest in the first place!



## GETTING AROUND THE GALAXY

Characters must secure some form of passage aboard spaceships. There are many different ways this can be achieved. The first is simply to pay a fare to board a spaceliner. This is expensive, but comfortable. The cost varies from solar system to solar system, but is generally somewhere between 50-150cr for a one way ticket. Round trip usually costs 150% the cost of a one way ticket. Interstellar travel is much more expensive, running anywhere from 1000-5000cr one way.

Another method of getting around the galaxy is to gain employment onboard a ship. The character works to obtain transport, but must have a viable job skill in order to be hired.

The third method of interplanetary travel is to purchase a vessel of your own. This is normally prohibitively expensive for most adventurers. One can purchase an outdated starfreighter for about 300Mcr.

There is yet another method of traveling around space: Steal someone else's ship. Since most ships are protected by highly sophisticated technology, including built in defense systems and robots, this idea is only for the craziest of privateers.

Characters can join the Galactic Services in order to travel off world. There are several problems associated with this endeavor. First, applicants must wait for a minimum 2 year period. Second, the service has a high attrition rate among its soldiers. Another one of the wonderful benefits of being a Forces soldier include spending most of your time in cryogenic freeze aboard overly crowded assault ships. Worse yet, you have to enlist for a minimum of 6 years.

The most plausible means of traveling about the galaxy is to sign on as a mercenary for a big corporation. This is easy. There are some 500 corporations, currently in need of combat personnel to guard outposts, explore potential new business sites, or battle hostile life forms. Applicants must be willing to sign a 1-4 year contract, obligating them to that particular company. For their services, the mercenaries are given special boarding privileges on all company vessels, plus a base salary of between 10,000 and 50,000cr a year plus incentives. Individual salary depends on experience and contract length.

## PEOPLE PLACES AND THINGS

**Aznermid:** This planet is a fringe world of the Milky Way Galaxy. The inhabitants, known as Hemareans, export cybernetic equipment. Characters can purchase cybernetic gear at a 15% discount.

**The Batukarai:** The most infamous pirate clan. They are comprised mainly of Orions and Phentari. The Batukarai have commandeered some 500 spacecraft over the last 20 years. It is rumored that the they have built a secret base in the Heinock asteroid belt of Ursa Minor.

**The Barrier:** At the end of the Universe, some 400,000,000,000 billion light years from Terra, there exists the Great Barrier. The Great Barrier is a powerful force field of unknown type and energy makeup. The barrier is impassable and, as of yet, no one has penetrated its boundaries.

*My curiosity drives me onward. I do not fear what may happen to me. I am here, here at the edge of the universe. This is all that matters. I don't actually believe it. Yes! Yes! I stand before the barrier that separates us from that which is beyond. By definition, the universe is endless. If so then why have I reached a seemingly dead end. This I must answer. My hands sweat with anticipation. For I am going to attempt what has never been done before. All my endless contemplations shall inevitably be resolved. There are two great questions. I shall certainly find the answer to one of them. They are: "What is on the other side of the great barrier?" The other is "What is it like to die?"*

Taken from the last transmissions of the Orion starfreighter Amus Dare, Captain Corice Makeln

**Cook's Planet:** The population of 25,000,000,000 Humans accepts fugitives seeking political asylum. The Alliance has been frustrated in its attempts to extradite persons for prosecution. It is currently contemplating military measures to terminate the problem.

**Chronus 2:** A planet where you can take damaged spacecraft and get it repaired, no questions asked. The planet is located on the fringe of the Milky Way, Quadrant 3, Sector 7.

**The Crystal Gardens of Nardriga:** A mythological place where one can be cured from any ailment. The planet is rumored to be located in Quadrant 2, Sector 1 of Carina. Many Zen Rigeln attempt pilgrimages to the mythological world. Supposedly, no one has discovered its true location.

**Dane:** A race of extremely powerful Entities. These beings are able to manipulate all the different types of matrices. They claim to exist at all times and places at once. The Dane also claim that they are here to stop the Alliance and all of its peoples from being destroyed. They won't, however, reveal to anyone what their true purpose is. They are extremely arrogant, and can take any corporeal form that they wish.

**Dameon Tremel:** The Galactic Executioner. This Gen-Human is the highest paid bounty hunter in the galaxy. He is legitimate, registering 1325 captures and 2480 kills to his credit. He is currently seeking the whereabouts of Jaquassarious Phentari, but is quite willing to take a little time out to improve on his numbers.

**Gemini:** These strange beings are mysterious in their intent and powers. It is recognized that they possess the ability to "generate" matrices. Gemini are bipedal rock-like creatures with some facial similarities to humans. Their skin is so thick that they possess a natural 3 point threshold. Gemins "generate" earth, water, and air matrices.

**The Graveyard:** Located 2 parsecs from the planet Renlulack, it is a museum where derelict spacecraft are taken. On occasion, some enterprising character comes here to steal some metal for his own purposes. The graveyard is patrolled by a single police cruiser.

**Jaquassarious Phentari:** The most wanted criminal in the universe. His most notorious act is the destruction of the planet Sharron by a thermonuclear device. His reason: "I was bored and found the need to entertain my superior mind ". It is estimated that Jaquassarious has killed some 40 million people during his infamous reign of terror.

**Krakeds:** A race of arthropods. Their planet is located at the center of the M24 galaxy. Krakeds are intellectually and technologically advanced, staunchly independent, and a formidable Alliance adversary. They possess a powerful navy, fielding more than 60 warships. The Krakeds have colonized planets up to 100 parsecs from their world.

**The Military Candidate School:** MCS is located on the planet Earth. Characters travel here to learn military leadership skills. It costs 10,000cr to enter. The class is three months of intense training and graduates receive 10% increases to leadership scores, gain 3 levels of proficiency in the weapon skill of their choice, plus accrue a total of 15 points worth of Military or Heavy Weapons skills. **YOU NEED TO HAVE THE PROFICIENCY POINTS AVAILABLE TO ATTEND THIS OR ANY OTHER SCHOOL.**

**Moig Dua:** A band of gypsy thieves who travel about the galaxy, pilfering from others. There are estimated to be some 50,000 Moig Dua. Most have pick pockets skill at 8-15 level of proficiency. They are predominately Orion Rogues, but there are a few Humans and Gen-Humans.

**The Mind School:** Trains Chatilians to more easily generate psycho-kinetic power. Accepted characters are taught 2-5 new matrices and gain 2 additional power points. The Mind School is located on Chatil. One must pay 9,000cr (base) to attend and must remain for 7-10 months. A full 10% of the students never graduate.

**Pleiaties:** The brilliant group of asocial scientists from the Tarus Minor star system. They research the problems of the universe and welcome dedicated outsiders to aid them. Characters can learn all science related skills at half the normal cost. The problem is that Tarus is on the frontier and it costs about 25,000cr to get there. Once you arrive, there is only a 50% chance that the Pleiaties will accept you.

**Releasement Center:** Situated on the Red Moon Xiarg, orbiting Kattel. Characters who are accepted into the prestigious training facility learn 2-5 new Healer Powers for 2000cr per level of training. They also gain 2-5 power points.

**Saxon:** A planet where sword mastery is taught. Characters travel here to learn swordsmanship at 1/2 cost.

**The School of Power:** It is an energy controller's dream to attend the renowned School of Power. Here one learns the powerful matrices of energy manipulation. It is difficult to gain acceptance. There is only a 10% chance. Each graduate receives 2 additional power points, learns 2-5 additional matrices of his current energy bracket, and 1 matrix of the next higher energy bracket. One attends the school for 9-12 months and it costs a minimum of 2000cr per level of training.

**The School of Swintash:** The famed school of Swintash is located on Eridine. Characters travel here to be students of the great Buddon Priests. The training is unparalleled in its intensity. Only 70% (90% of Eridani) pass the course. Those who do gain 4 levels of proficiency in any archaic hand weapon and 2 levels of body equilibrium. The school costs 5000cr and takes 2-5 months to complete.

**The School of the Mask:** A school where espionage is taught. Characters enroll for 15 points worth of occupational skills. There is a 05% attrition rate and it costs 10,000cr to attend.

**Sheustron:** A vaguely humanoid race with large, flat, featureless faces. Sheustron excel at the application of mathematics and science. They boldly claim that there isn't any weapon, vehicle, or other object that can't be built. "It is just that a Sheustron hasn't put his mind to it". The Sheustrons specialize in producing unique and unconventional goods at a reasonable price.

**Yontacha:** A secret society of brain washed individuals who believe in peace. They pursue this nebulous concept by sacrificing warrior types. They do so without chagrin. "These warriors are but the true evil in all of us. They must be purged of their sins." Captured persons are sacrificed by having their blood drained. Believe it or not, there are some 150,000 Yontacha. Their leader is called Odak. There is a standing 2,000,000cr reward for any information leading to his capture.

## GALACTIC PHENOMENA

Travelers risk danger from other things besides the Arachnids, Rebels, and Pirates. There are many natural dangers that warrant attention. These are called Galactic Phenomenon. Most galactic phenomena have been charted and are located on maps. Ship captains steer clear of these potential dangers, but exploration ships are not always as fortunate. The jump to hyperspace is precalculated. To some degree, it is a blind jump. One can avoid planetary obstacles and asteroids. However, a captain is blind to certain phenomenon which are difficult to detect with long range scanners. The result of jumping into the wrong location can be disastrous.

**Black Holes:** A collapsed star. This most dangerous of phenomenon has such a strong field of gravity that even light can not escape its grasp. Any ship that approaches within 1 parsec of a black hole, risks being sucked into the "body." The risk of being sucked into a black hole depends on the weight to thrust ratio of the spacecraft.

**Dust Clouds:** These clouds cover huge distances of space. The clouds can be devastating to the unwary ship that blunders into them. Dust clouds are composed of tiny finite particles of matter, held together by intermolecular and electrostatic forces. For each point of vehicle speed, up to 1HP of damage is done to the ship. The effects are determined every minute.

**Ion Storms:** A common feature of the universe. Intense amounts of electromagnetic radiation act to render a ship's flux shields useless. Scanners don't work and sensors suffer a -50 modifier to detection rolls. ECM and ECCM are useless when operating in an ion storm. All energy based weapons have their effects halved. Like dust clouds, ion storms cover huge expanses of space. They are by far the most prevalent phenomenon.

**Pressure Ridges:** This unexplained phenomena has scientists completely baffled. High gravitational fields buildup in the complete emptiness of space. These steep "pressure gradients" can completely destroy a ship. For each point of speed, 1-4HP of damage is done to the vessel.

**Pulsars:** Produce powerful gravity waves. The standing wave is 100HP strong at the epicenter. The wave sweeps outward, losing 1HP of strength per 50,000km. Pulsars emit pulses every 10-40 min.

**Quasars:** Quasars emit powerful radio waves. Vessels that approach within 1,000,000km of a quasar are subject to its effects. Communications capacity is reduced by 02% per 10,000 km of closure.

**Radiation Belts:** Quite deadly. Flux shields are useless. Sensors lock on at a -20 penalty and scanners function at a -30 modifier to detection rolls. Gamma radiation penetrates the hull. Characters must roll SMRs vs radiation at a +30 bonus to dice rolls. Neither transporters nor tractor beams function in a radiation belt. This phenomena is found predominantly around stars, but may be located anywhere.

**Sunspots:** The mixture of slightly cooler materials coming in contact with hotter pools is what causes the phenomena. All communications are knocked out for 2-8 hours. Scanners are rendered inoperable for the entire time that the ship remains within a 1000km of the activity. ECM and ECCM are knocked out for the duration of the exposure.

**Novas:** The collapse of a star that has used up all of its hydrogen and begins to burn helium. The explosion spreads outward, destroying anything in its path. The initial explosion damage does 100,000HP of damage. It loses strength at a rate of 100HP per 100,000 km distance from the epicenter. Deadly radiation and ionstorms can extend much farther than this. It is advised that you be several thousand parsecs away at the very least.

## THE MOTARAN RIFT

In the center of the super star cluster called Ursa Major, there exists the greatest scientific phenomena ever recorded. Scientists have recorded a tear in the fabric of time, a place where alternate universes apparently come together, an object that is not an object. What the Motaran Rift exactly is, no one is quite sure. The mouth of the rift is 10 light years across, but fluctuations have been recorded out to 20 light years and as small as 2 light years. The highest paid mercenaries in the universe are the Rift Runners. These intrepid warriors (foolish idiots) are sent into the rift to make scientific measurements and to explore the reaches of this fascinating anomaly. The Motaran Rift simultaneously exhibits qualities of mass/energy. Occasionally it appears to be alternating between the two. The only conclusive evidence has been drawn about the rift is that it connects space to itself, an astral conduit that links points in space to other points millions of light years away. A perpetual worm hole. Rift Runners have entered the rift in one spot and instantaneously appeared hundreds of light years away in another.

The rift produces still stranger and more bizarre aspects. Often dangerous lifeforms called Entities exist inside this quasi-void and seem to move freely within it. Apparently, many an unfortunate Rift Runner has encountered an Entity, never to be heard from again. Other explorers of the Motaran Rift have recorded solid planet like masses. Still others claim to have found heaven, somewhere deep inside the hole!

The ultimate in adventure is to enter the Motaran Rift. The ultimate success is to survive to tell about it. Orion Rogues line up to get a chance. It figures!!!

## TECH LEVELS

Not everyplace in the galaxy evolves at the same rate. Many places are behind the rest of the galaxy in technological advancements. This brings up the problem of deciding how advanced any particular planet is. Thus we have created tech levels. Tech levels are the Alliance's means of determining how advanced a planet is.

**Level 0:** These planets are below what most people consider civilized. Inhabitants have not reached the Urban Revolution and are mostly hunters and gatherers. (Prehistoric)

**Level 1:** These planets have reached the age at which they can call themselves civilized. Inhabitants generally live in cities. There exist arts and crafts and the people have time for activities that are not pertinent to survival. (Earth from Egyptian Civilization to 1850)

**Level 2:** Planets that have reached Tech Level 2 have become industrialized. Machines are now used regularly to ease the work of the people. (Earth 1850-1969).

**Level 3:** Space Age: These planets are beginning to explore space. They have explored their own solar system and may have contact with the Alliance for trade purposes. (Earth 1969-2049)

**Level 4:** Interstellar Age: These planets have achieved Interstellar travel and move freely about the galaxy. Most races that have achieved this level are engaged in space colonization.

**Level 5:** Intergalactic Age: These planets have made it to the point of being able to travel to other galaxies and thus anywhere in the known galaxy. They are usually annexed or brought into the Alliance.

**Level 6:** Galactic Age: This is the top of the technological ladder to date. Usually only capitals and major planets of the 12 major races have attained this level. Tech Level 6 represents the cutting edge.

**Beyond:** There are rumors that there are planets in our own galaxy that have exceeded the Alliance itself in technology. Experts (idiots who haven't been proven wrong yet) believe it to be highly unlikely that any still exist in our galaxy without our knowledge. Yet, it has been shown that civilizations such as that of Atlantis may have existed in the past. Who knows they may still exist out there in this vast universe.

## THE FINAL FRONTIER

*The thing is absolutely huge. That is all there is to say about it. You can travel seemingly forever in any direction before you run into anything. And when you run into things, they often as not seem to be vicious, and try to obliterate you. So if you are meek of heart, or intend to live out a frightfully long and boring existence, then stay at home, because out here, things and people aren't "Playing".*

Niles Oshaunesse

"Orion Rogue extraordinary", last seen at the Carmal Asteroid Base in Quadrant 2, Sector 7 of the Fornax galaxy December 31, 2261 BC.

The Core worlds are frighteningly boring compared to what's happening on the Frontier. They all have stargates, extensive overhaul facilities, and lots of police. Most young adventuring Battlelords realize that being where the action is probably means being more than a couple hundred thousand light years from the comfort and safety of one's bed. Huge volumes could be set aside just to develop star systems and it is my very intent to do that one day.

The Local Group maps shows a two dimensional display of where the closest galaxies are to our own. It is designed to provide a frame of reference for adventuring. Characters can travel between the various galaxies by utilizing the stargates.

Each galaxy is broken down into 4 quadrants and each quadrant is further divided into 8 sectors. "Hot Spots" are active quadrants of the Frontier. They are where the proverbial "action is".

# Quadrant 1, Sector 3, Fornax

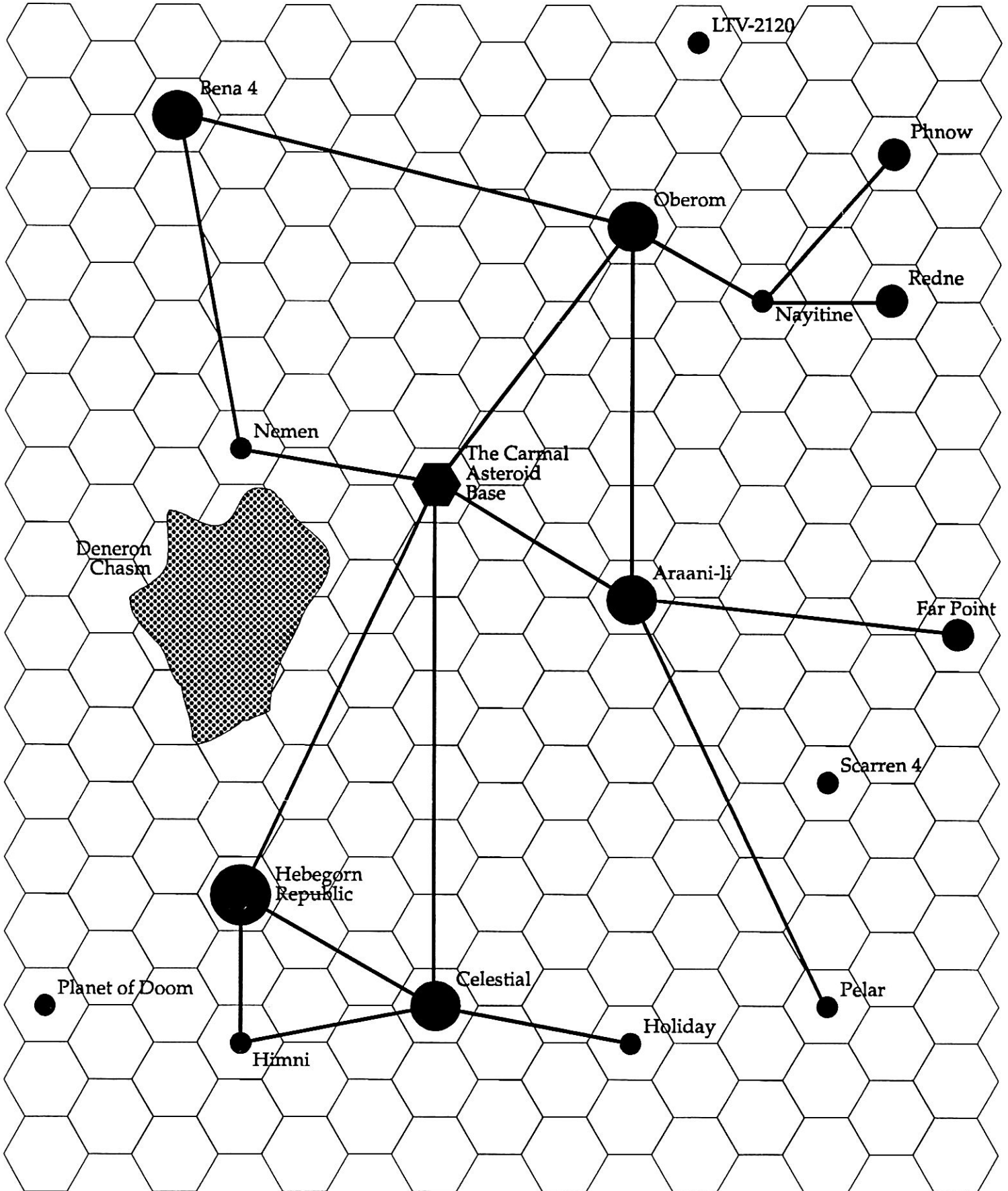

## QUADRANT 1, SECTOR 3, FORNAX

It is called The Barrio by those who live here. The Barrio is tough, and ruthless. It is shrouded in a web of corporate deceit, political intrigue, and mystery. Just remember to always keep one eye looking back or some punk will jump you.

**Oberom:** "If you are looking for action, drop by," said one official. Oberom is an arsenal waiting to go nuclear. The planet is on the verge of a civil war, the scourge of democracy rearing its ugly head. The communist are barely holding control, gaining support from Eridani backed arms companies. The freedom fighters look to the Rebels for materials of war. Furthermore, a cult murder/suicide movement has swept the planet with hundreds slaying each other daily.

Oxygen base, with slightly lighter than earth gravity, Oberom is a world centralized on one continent. A deciduous climate prevails except at the poles.

**Nayitine:** Nothing particularly special about this lump of dirt in the middle of nowhere. Travelers can pick up only crude fuel and basic supplies. Limited refit. No overhaul. Nayitine only has two small dome cities, Nazul and Dimeree. This Alliance planetoid is owned by the Asteroid Mining Consortium. Produces limited Plutonium, Cesium, and Uranium. Mutzachan mentors abide here. No atmosphere. 2/3 Earth gravitational force.

**The Carmal Asteroid Base:** The heart of the frontier, a thriving trading post owned by Carmal Oshaunesse, the great Orion merchant. Carmal is a bustling elegant structure. It is a monumental achievement in luxury, technological sophistication, and social pooling, lending itself to pure hedonism. Carmal is a web of political intrigue, espionage activity, and danger. The space platform caters heavily to its local constituents, maintaining overhaul facilities, high grade fuel, legal services, and runs its own stock market.

The Carmal outpost is essentially the only link between the Alliance and the distant Melkarain Confederacy, an independent Union of star systems fielding a formidable navy and army. Both, the Xarian Wolk and Kraked Syndicracies make their home there.

**Nemen:** Its only redeeming value is that the Balshrom Headquarters for this quadrant is located here. Offers 10-20% discounts on all Balshrom products. There are 4 cities, Millerville, Oakhaven, Mountainview, and New Buffalo. The rest of the planet is a top secret weapons facility and test ground. Security clearance required to land here. Nemen is patrolled by 2 Alliance destroyers and a heavy cruiser.

**Hebergorn Republic:** Capital world to Heberganese, direct decedents from Humanity on the planet Earth. This Atlantian colony has recorded histories predating 5000 B.C. Hebergorn is the largest of the three heavily populated Heberganese worlds. It is an Alliance colony. It produces huge food stores, predominantly agricultural products. Little crime. Restricted movement for Phentari.

**Celestial:** Population 7 billion. Heavy industry. No weapons over Tech level 3 permitted. Diverse culture. This is the industrial Mecca of the Hebergorn Republic. Humans openly invite Cizeracks to join their culture.

**Himni:** The last and least important world of the Hebergorn Republic. Himni is some 4.5 parsecs from Hebergorn. Only 2,000,000 people live here where little science outposts dot the frozen ice cap. Heavy Asteroid Mining Consortium influence.

**Planet of Doom:** Named after two Phentari colonies mysteriously disappeared with no trace of the inhabitants. The planet contains vast quantities of Cesium. Unclaimed.

**Holiday:** Actually, a ruse to try to attract settlers. Holiday is a swamp filled, creature infested planet, not even remotely tamed. Considered non-cost effective for settling. Rebel activity reported near. Code yellow clearance for all ships passing within 5 parsecs.

**Pelar:** A large Zen contingency abides here on this peaceful world. Excellent medical facilities. No weapons permitted. Mentors. High grade fuel. Some refit and overhaul.

**LTV-2120:** Eridi-Corp recently acquired this planet, but due to competing interests from outside sources, has yet to establish its control. No spaceport. Homesteaders have taken up ground here and small feudal territory/kingdoms are rising. Hiring mercenaries. Import weapons.

**Araani-li (Silence):** An exclusive Chatilian resort world, designed to offer peace and quiet to empaths in need of seclusion. Mentor training. Araani-li is the renowned historical and information center, with the Sarands and Chatilians building a huge archives called Armas Latinum. Unfriendly to outsiders. No weapons. Excellent personal and vehicle service.

**Scarren 4:** An unexplored planet inside the Maraden Radiation zone. Code red travel warning. All travel to Scarren 4 is forbidden.

**Bena 4:** A fast growing industrial center. Extensive slave trade. Benase vaguely resemble Humans, but have short hunched bodies and large oblong heads. It is the corporate headquarters for Teledyne in this sector. The capital city Bena is the location of a large quarantined zone called the "Pit." The Pit contains mutants infected by a virus that has flourished for 250 years. Planet Population: 30,000,000,000. The Alliance is currently building another battle station here and it is half way complete. Moig Dua present.

**Phnow:** A Phentari colony planet. Phnow mass exports slaves, mostly Benjari whom they breed. Orion Pirate clans are known to operate out of Phnow, at the rage of Eridani officials. Phnow is at a tenuous cease-fire with the Eridani who inhabit nearby Redne, only 4 parsecs away. Extensive Phentari military presence.

**Redne:** A steady military build up is occurring on Redne, a large Eridani colony currently at war with Phnow. Redne is a methane gas giant. Mercenaries wanted. Eridi-Corp bases its operations for the quadrant out of Redne.

**Far Point:** Was recently claimed by the Space Systems Development Corporation. Exploration teams are currently being deployed to the planet. Untamed world.

**Deneron Chasm:** Is a huge asteroid belt. Hundreds of vessels have entered it, never to be heard from again. Prohibited from travel.

## QUADRANT 3 SECTOR 7, ANDROMEDA

**Fact:** If you are a young, snot nosed, wet behind the ears adventurer, then turn your !\$@!\* around and head right on back to where you came from! This sector is called Kodiak Country and if you aren't wearing Kodiak or better armor, then you had best stay away. Kodiak is a tinderbox ready to explode, with danger lurking behind every skimmer. If that doesn't put fear into your soul, then the fact that Arachnids roost here when they want to knock off a couple million Alliance subjects or so should.

Kodiak Country is right at the edge of Alliance controlled territory and many of the worlds here were recently destroyed during the last Arachnid Incursion. Battle stations are springing up like tulips in May in Kodiak Country, and so are the graves.

# Quadrant 3, Sector 7, Andromeda

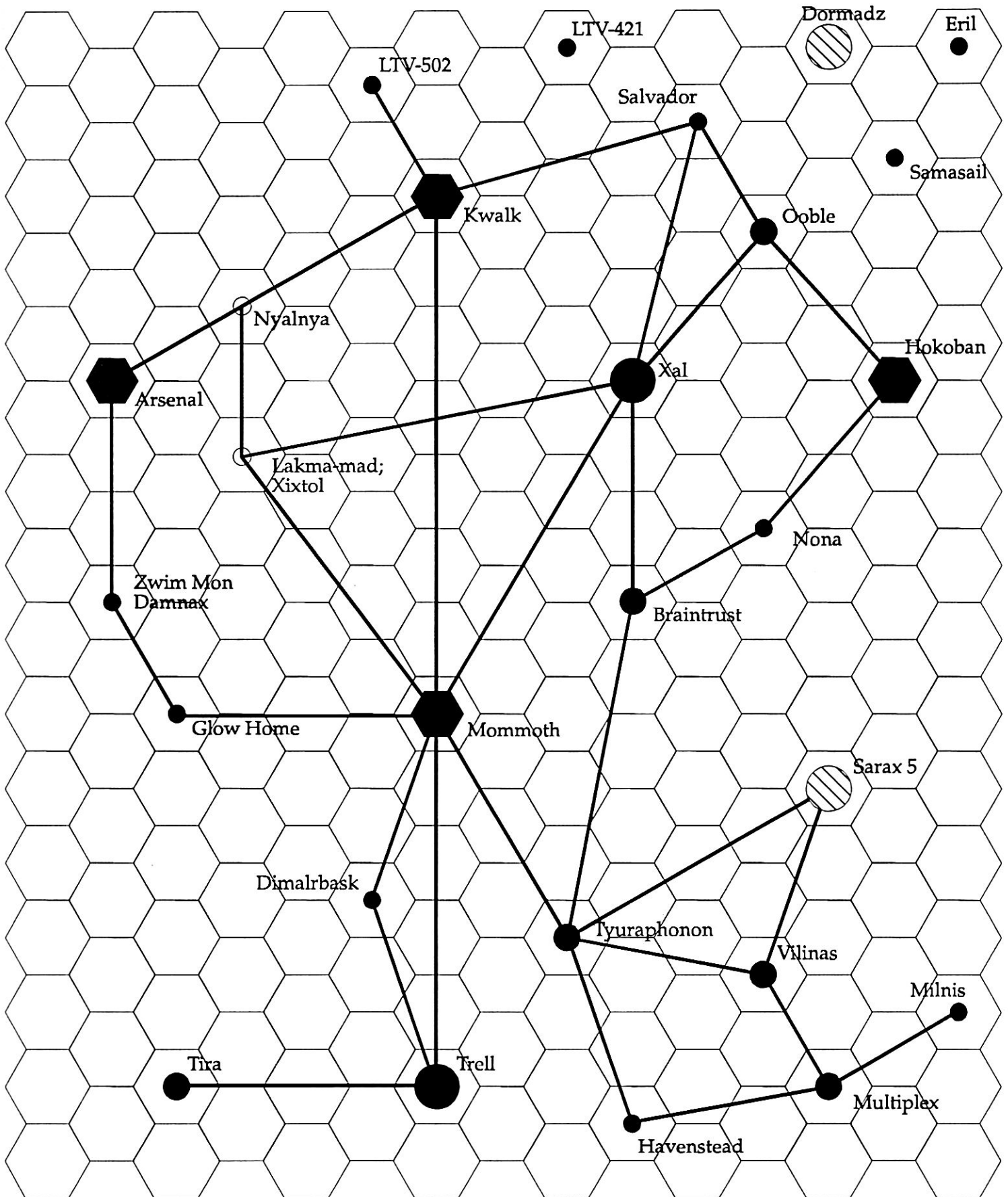

**Dormadz:** Located less than 10 parsecs from LTV-502. The settlers are also under attack by the Arachnids. This corrosive world is owned by Teledyne Syndicates which is currently hiring mercenaries at a 20,000cr combat bonus on top of a negotiated salary. The densely populated colony lives underground or in dome cities.

**LTV-502:** An Eridani colony in the LTV-502 system was flourishing until it was attacked by the Arachnids. Suspected of having gold reserves. Miners needed. Hiring mercenaries at negotiable salaries.

**LTV-421:** LTV-421 is a Gen-Human mining colony. Most of the 2,000,000 inhabitants are infected by a strange plague. The planet is currently quarantined and is off limits to all non-medical personnel.

**Glow Home:** Named so for its plentiful amounts of radioactive resources. Glow Home is a desert world, owned by SSDC. The company has huge strip mines covering thousands of square kilometers of the planet's surface. There is a small Mutzachan rest home on the Equator, otherwise the rest of the planet is dotted with mine support towns. Open to travelers. Mercenaries hired to combat a variety of problems. No gun laws.

**Mommoth:** The hub of commerce for this quadrant. Starbase 124 holds high orbit above the planet, populated by a majority of human types with strong contingencies from the other warlike Alliance nations. The 7th Fleet makes its home at Mommoth. Travelers enter this quadrant through the stargate at Helm, the capital city. Mommoth possesses a variety of resources metals, agricultural, and textiles. It is densely populated with some 6 billion residents. The planet is the jump off point for military vehicles in their continual battle against the Arachnids. Mommoth has garrisons of 4.7 million galactic defense personnel. It is a deciduous planet with much of the same properties as Earth. Democracy.

**Tira:** Desert world that produces large amount of Mesange Nectar. The planet is owned by the Orionus Konglomerates. Tira is populated mostly by migrant workers from all over the galaxy. It imports large amounts of water. Tech Level 2.

**Tyuraphonon:** Destroyed in a biological war with neighboring Trell. Uninhabitable. A chemical and biological wasteland.

**Trell:** Severely damaged in the recent war with both Tyuraphonon and Dimalrbask. The planet is in a state of anarchy, violent factions straining for control over the government. Martial law is in effect, but not adhered to. The people are called Dranits and are reptilian.

The spaceport is in ruins. Low grade fuel available. Mercenaries wanted to stop the bloodshed. Some chemical contamination.

**Dimalrbask:** Once an industrial and prospering planet, Dimalrbask is a mere shadow of its former self. Some overhaul facilities and medium grade fuel available. The spaceport is only partially functional. A Rebel uprising is currently being suppressed by the Alliance, along with mercenary troops.

**Arsenal:** A stock pile planetoid where vast stores of Alliance military equipment are kept. The Magna Battle station is in orbit here, complete with stargate. Off limits to all non-military personnel.

**Ooble:** An industrial powerhouse, settled by Chatilians and Humans. Deciduous environment. Black Market connections.

**Hokoban:** A Zen Rigeln agro-world, providing 75% of the quadrants food supplies. Battle station Nirvana is located here.

**Braintrust:** A strange and mysterious world built by automated robots. Only matrix controllers are allowed to land here. Extensive training in the Black Arts (non-legislated matrix manipulation) is available. Standard training also available. Owned by Nagilack, a 24th level Mutzachan energy controller.

**Zwim Mon Damnax:** Razed by Arachnid forces. A new outpost is currently being built.

**Xal:** A Xarian militocracy suspected of keeping strong Arachnid ties. Unfriendly toward outsiders. Boasts a formidable military. Xal is an independent planet.

**Nona:** Protected from outside intervention, Nona is a Tech Level 1 Alliance experiment. Tech Level 1 weapons only. Chatilian and Zen mentors are present.

**Salvador:** Destroyed by Arachnid forces. Some survivors. Reduced to Tech Level 1. Violent feudal cultures.

**Nyalnya:** No atmosphere. Mines minerals and limited metals. Only 20,000 Gen-Humans and 1000 Mutzachans dwell here. No overhauls, but crude refined fuel available.

**Kwaik:** Top Secret Alliance military outpost. Trespassers will be shot on sight. Battlestation Rascal sits in orbit above the planet. Personnel can stop here for food and short term lodging. The planet is an ice pack.

**Havenstead:** The last planet considered safe for Alliance colonization. Only 150,000 Orions dwell here, making their living from raising Cashou for sale at the slave markets. This desert world imports water.

**Samasail:** Unexplored volcanic world.

**Eiril:** Unexplored, but claimed by the Eridi-Corp.

**Lakma-mad Xixtol:** Untamed jungle world owned by SSDC. The company is currently hiring mercs to "revitalize" the landscape.

**Vilinas:** An emerging Tech level 3 Human planet, similar to Earth in the late 1900's. A large contingency of Hemareans make their homes here.

**Multiplex:** An extravagant resort world geared to provide the ultimate fantasy for its visitors. Run by the legendary Orion Horice Takeln, long time pirate and racketeer. Black Market connections. Pirate services. This independent planet boasts a large navy and is currently under the watchful eye of the Alliance.

**Mulk:** Water world. Large colonies of Python Lizards aid Humans in the exportation of water to surrounding locals.

**Sarax 5:** Two Eridani exploration teams and one Alliance combat team have disappeared while fighting in the maelstrom, corrosive atmosphere of Sarax 5 which is believed to possess large amounts of Tritium. Untamed. Orbiting platform.

## INNER CIRCLE

The Inner Circle represents the core of the Alliance's infrastructure. The names of the systems listed on the Inner Circle map can be cross-referenced with "Planet of Origin" on page 51. Note: Some systems, while not listed, contain small colony worlds that are not important.

**Pythos:** The 4th planet of the Floridian System. The inhabitants are primarily Python Lizards, Ram Pythons, and a small contingent of Gen-Humans. The people of Pythos are generally unfriendly toward outsiders.

**Ashira:** The 5th planet in the Floridian System. The inhabitants are a mixture of Ram Pythons and Python Lizards. Ashira is tolerant of visitors and is currently operating under the military dictatorship of General Motish.

# The Inner Circle

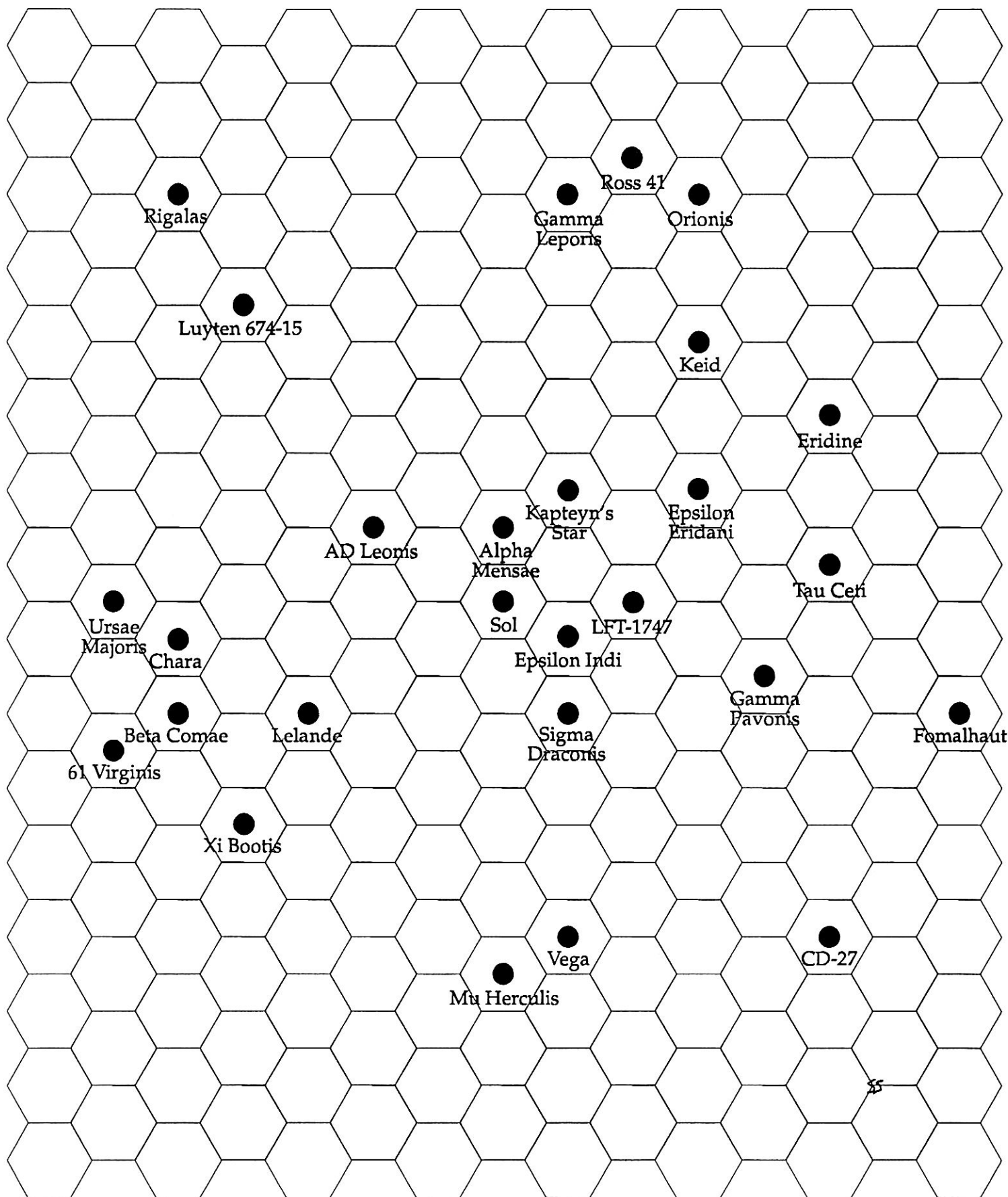



**Cashoulis:** The 9th Planet of the Antares Star System. The society is diverse, predominantly Cizerack, Gen-Humans, and Eridani. The Cizerack are a matriarchal society. Cashoulis has excellent vacationing facilities and welcomes outsiders. The government is a matriarchy.

**Avisham:** A permanent Cizerack mining facility. Cesium is mined in large quantities. Secret military operations are currently being carried out on Avisham and a security clearance is necessary to land.

**Karas:** The Mazian home world. Karas is ruled by King Blodishn the 4th. Outsiders are welcome but seldom travel here. The average surface temperature is 49C/120F. Over 90% of the planet's surface is covered with water.

**Kobul:** A Mazian world. Kobul is currently at war with indigenous, amoeba-like lifeforms. The toxic atmosphere prohibits most outsiders from stopping here. Mercenaries are welcome.

**Zalimar:** A "hot" vacation spot for many Gen-Humans who come to linger in the lavish accommodations of the five star, Rosehan Hotel. Mixed races are present, but the populace is predominantly Mazian. The Mazians generally take on human form when near tourists.

**Chatil:** Is the home world of the Chatilian empathis. Its people are tolerant of outsiders. The inhabitants favor secession from the Alliance. Chatil is mostly a self-sufficient planet that only imports slaves. It is a Galactic hot-spot for vacationers. The climate is similar to that of middle latitudes on the planet Earth.

**Trishmag:** The center of the Mutzachan empire. This barren world has very high levels of radiation. The Mutzachan highlords keep the top secret technology of the stargates here. The inhabitants are tolerant of outsiders. The School of Energy is located on Trishmag. The planet's environment and atmosphere are deadly to all, except the Mutzachans.

**Taos:** The capital world of the Orion Rogues. Taos is the trade capital of the known universe. The planet is run by powerful trade guilds. Plas-Steel is synthesized here.

**Draman:** An Orion separatist colony, seeking secession from the Alliance. It is rumored that Draman is a Rebel Base. A security clearance is necessary to land. Outsiders are seldom allowed.

**XL-4:** Is a Top Secret military operation center for bio-genetic research. Gen-Human and Orion scientists make up the population.

**Phena:** The home world of the Phentari. It is ruled by the tyrant King Moginthinz. Phena is tolerant of outsiders and a small colony of Gen-Humans and Mutzachan live at Clim City on the polar icepack. The inhabitants of Phena are warrior types. Government: Militocracy.

**Werimus:** A separatist Phentari world. The Wermeans view slavery and war as barbaric. They are a disgrace to the rest of the warring Phentari peoples. Wermeans have continuously resisted control from outsiders. The planet is loosely tied to the Alliance and rumored to be a Rebel base.

**Phelinar:** A top secret military colony, located on the fourth planet of the Char System. Security clearance is needed to land. Outsiders are prohibited.

**Eridine:** This ringed world is the homeworld of the Eridani. The capital city Gujag is located 1000km above the planet's surface. Eridine thrives under the matriarchal rule of Regent Housanil. The famed School of Swintash is located here.

**Katrel:** The home world to the entire Zen Rigel nation. All weapons are prohibited. A pacifist group of Gen-Humans co-inhabit the planet with the Zen Rigel. Katrel is a known Rebel stronghold.

**Earth:** The planet is controlled by various mega-corporations. Earthlings are generally friendly toward outsiders, but prohibit Phentari from residing here. Dangerous radiation hot spots exist on the North American continent and Asia. Earth is a big vacation spot for Mutzachans.

**Mars:** Mars is ruled by President Brenda Shier. The government is a republic. Weapons are prohibited.

**Terra:** The capital of the Galactic Alliance is located here. Terra is the home world of the Gen-Humans. A large contingent of Mutzachans live here also. The Council of Timar makes its office here at New Washington. Terra is a major trade center and the populace welcome all types.

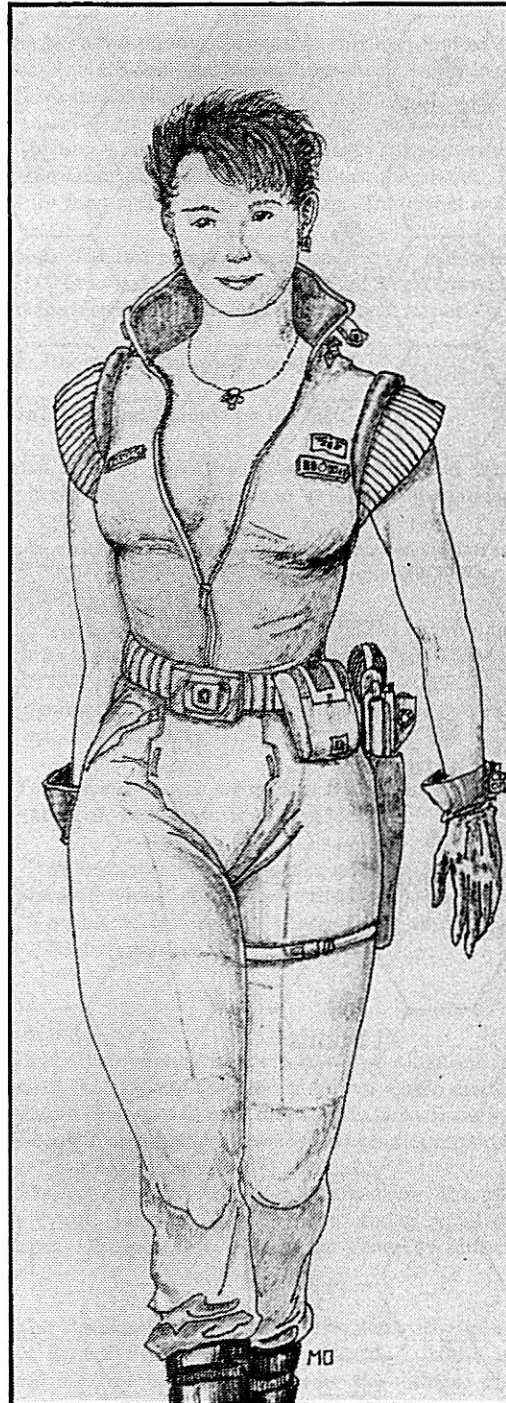



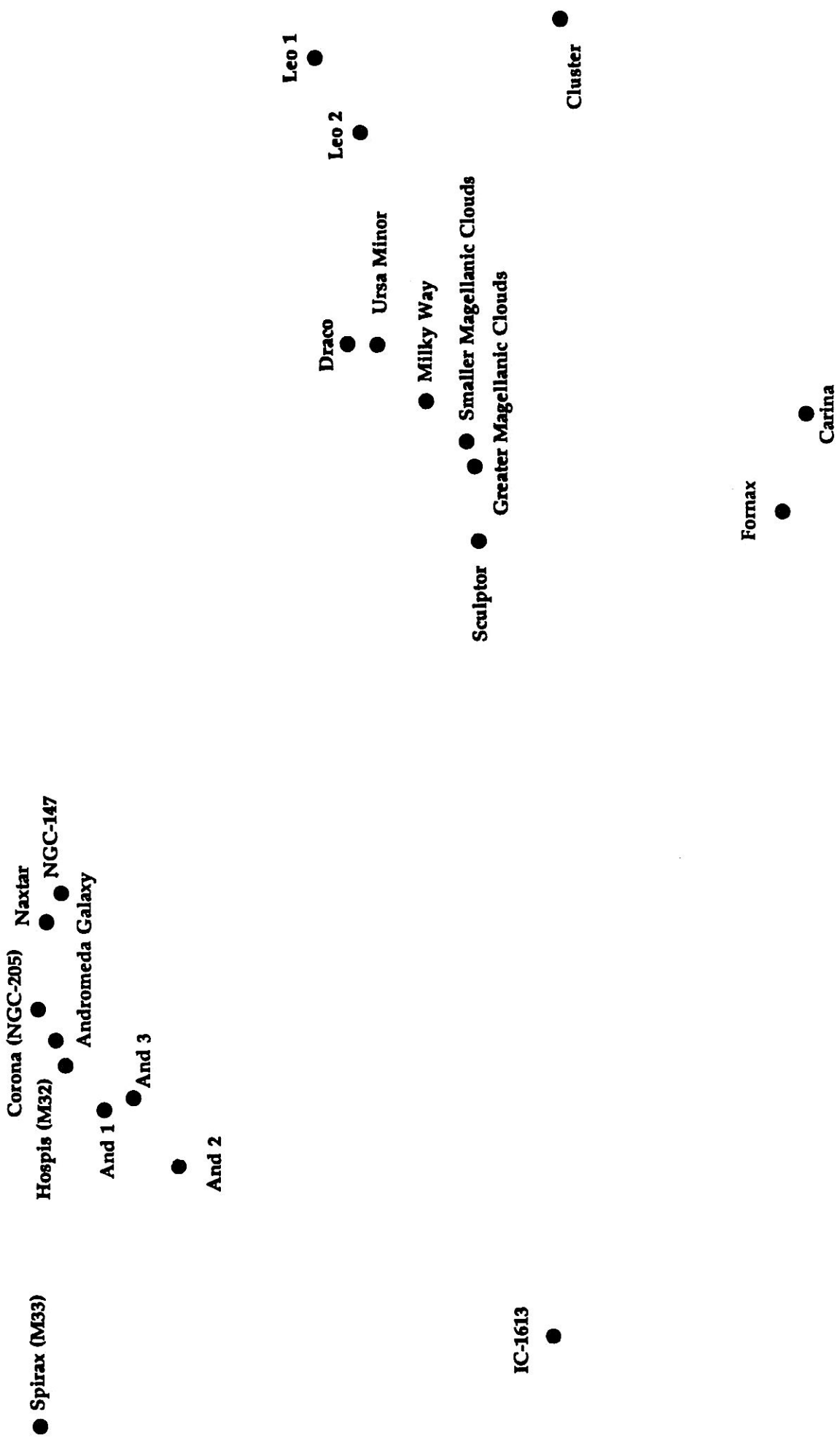







**Oshinthar:** Home to an insectoid race called the Sarands. The Sarands are the Galactic Sages. The Library at Contas holds records of all known Galactic events within the last 15,000 years. Outsiders are tolerated. Some 20,000 Chatilians co-inhabit the planet with the Sarands.

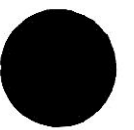

# LOCAL GROUP

# MAP LEGEND

	Population less than 5,000,000.
	Population between 5,000,001 and 50,000,000.
	Population between 50,000,001 and 500,000,000.
	Population between 500,000,001 and 10,000,000,000.
	Population over 10,000,000,000.
	Planet has no atmosphere.
	Planet has a corrosive atmosphere.
	Asteroid Belt.
	Base present in orbit.
	Travel Route.

**QUADRANT MAP DISTANCES:** Each HEX (2.5cm) equals 4 parsecs

**CORE WORLD MAP DISTANCES:** Each Hex (2.5cm) equals 1 parsec

**LOCAL GROUP DISTANCES:** One inch equals 100,000 parsecs

**THE MASSING EFFECT:** Scientists are still quite puzzled about what they call the Massing Effect. For some unexplained reason, the bulk of all life found in the known universe has been discovered within 100 light years of the planet Earth. No real theory has been accepted as to why this phenomena has occurred.

## SPECIAL POWERS

### STARTING POWERS

All Matrix Controllers (MCs) begin the game with the ability to generate certain powers. These represent the powers that the pupil has already been taught by his Mentor. Normally, a character begins the game having learned 2-5 1st energy bracket powers and 1 from the 2nd bracket. To determine the starting powers, the player picks two of his choice. The BM chooses the remainder. The character can generate these matrices any time, as long he has the internal energy to do so. Players may choose any of the stated powers from the appropriate Power Tables. One's starting powers are subject to modification by the Matrix Controller's Fortune Table. Mutzachans always start with the Drain matrix in addition to the normal starting powers.

### ENERGY BRACKETS

There are 9 energy brackets of power. They represent the relative degrees of advancement in matrix manipulation. Brackets of energy are divided into three segmented levels, representing novice, moderate, and expert controller within that category. One may only generate powers within his energy bracket without incurring problems as noted below. All characters begin the game at the first energy bracket. When a MC reaches 4th level of proficiency, he can generate a power from the second bracket. At 7th level he can generate a 3rd energy bracket power. A character may opt to generate a matrix from one energy bracket, above his own. A 5th level MC commands power in the 2nd energy bracket. Fact: He can generate matrices from the 3rd energy bracket, but at double the base cost.

### POWER POINTS

"Power points" denote the amount of psycho-kinetic energy that a character can generate per solar day. Untrained matrix controllers can harness and control only a small portion of their potential powers. The amount that they can control is called their Power Point Capability. Normally, a beginning character has a power point capability (from now on referred to as PPC) of 1. The PPC is modified by high intelligence scores. SEE INTELLIGENCE. A typical starting matrix controller has a modified PPC of 3-4 power points per day. He can channel no more energy because generating is very taxing. The process of channeling matrices is very draining. However, as he works the matrices more and more, learning to finesse rather than force out the power, eventually the matrix controller (MC) can harness and transmit huge amounts of power. Matrix controllers lose constitution temporarily every time they generate. They lose constitution in proportion to the fraction of their power points used. One half the fraction of power points used is lost in Constitution. Thus, if Henry the Mutzachan had 4 power points and used up 2 points, then his constitution would be reduced by 25% of the norm. If he uses all his power points, he loses half his original constitution. Sleep restores lost constitution.

A 1st energy bracket power requires 1 power point to generate. This is simple enough. At any time during any given day, the MC merely calls on the learned power and channels it. So a MC with a PPC of 3 can generate up to 3 different 1st energy bracket powers on any given day. A character can generate powers higher than his skill level. This is very difficult. It drains twice the power necessary to generate the matrix.

**Example:** Henry is a 1st level Mutzachan. He has been taught a power from the second energy bracket. It costs  $2 \times 2 = 4$  power points to generate. Henry is smart and has a PPC of 4. It takes all of Henry's power to generate the matrix and he can generate no other powers for the remainder of the day until he has sufficiently rested.

## EXPERIENCE AND POWER GENERATION

A matrix controller's experience points are divided in half for purposes of advancement. Half of all earned experience goes to learning new occupational skills and the remainder is used for advancement!!! His progression is dictated by the Matrix Controller Advancement Table below. At each new level, the MC accumulates more power points, as listed on the level advancement chart. Upon entering each new energy bracket, he becomes more efficient and thus more dangerous.

### COLORS AND TITLES

All MCs must wear the color symbol of their energy bracket in the form of an ornate robe. This is Galactic Law. Characters caught not wearing appropriate garb are subject to strict punishment.

All MCs must give their title when in the presence of any galactic official or other Alliance military personnel. Again, this is Galactic Law. There can be extreme consequences for those who fail to wear the proper attire and use the proper title.

### GAINING NEW POWERS

Characters gain new powers by seeking out a master to teach them. The master is called a Mentor. The matrix controller must pay money for the teachings and spend long periods of time in the solitude of the Mentor's abode, learning how to master the new matrix. The chance of successfully finding a teacher on a given planet equals 70% plus 05% per proficiency level of the MC. The chance is reduced by 20% per level of energy bracket. This reflects the difficulty in finding a teacher at high levels. Learning the power requires 2-5 weeks per energy bracket. New matrices are not automatically gained when the character gains a level.

### DURATION

Denotes the length of time that the energy matrix remains stable and intact, subsequent to initial generation. Energy emanates from the MC during this time. Normally the MC need not concentrate further, but there are exceptions.

### GENERATION TIME

This represents the amount of time that the MC must concentrate to "generate" the power. He goes into a deep trance like state of concentration during this period. Anything that disturbs his concentration, automatically voids the power. The energy needed to generate it is lost. The time it takes to generate is affected by the initiative roll. There is a minimum 3 second delay between generations.

### BOOSTING

Powers have a specific duration before they run out of energy. An MC can boost the duration or the effect of a particular power by pouring more energy into it. The MC must tell the BM that he intends to do this at the beginning of every new combat segment. Only certain specified powers can be boosted. Otherwise the matrix runs out of energy at the end of its duration.

### SPECIALIZATION

Beginning matrix controllers can specialize in a particular field. A matrix controller can increase his PPC by sacrificing proficiency points at a rate of 5 occupational proficiency points per added power point. One can never gain more than 3 power points in any one 6 month period. Chatilians, Zen Rigel, and Mutzachans can opt to specialize at any time that they choose.

## LATENT EXTRACTION

All individuals possess the power to generate, but for some races this is a difficult matter. Their inherent physiological makeup prohibits natural generation. Only those individuals with an intelligence rating greater than 80 can attempt latent extraction. Latent Extraction is the process of remapping thought patterns through intense meditations called Releasements. The individual learns to "let go of the inner self".

The method for rolling up latent characters follows certain rules and constraints. First, the character begins the game with no power points. He chooses which type of matrix controller he wishes to be and then pays a flat rate of proficiency points for initial extraction. The cost represents the enormous amount of time that is spent meditating in order to tap into the inner self. It costs 15 points to learn Healer, 25 points for Empath, and 35 points for Energy Control. The character then purchases power points as per specialization above. A maximum of 4 power points can initially be purchased. Latent extraction may allow characters to generate, but with complications. Latent characters need twice the experience to gain new power points and never generate matrices from the fifth energy bracket or higher. It takes double time and cost to learn new matrices. Mentors charge more for Unnaturals. PCs start with 1-3 random 1st level powers.

Characters must begin the game as latent controllers. Those who wait until they are established to undergo latent extraction, must pay double the normal proficiency costs for the initial extraction. It is rumored that Twan Kiel, a prominent bio-geneticist has discovered a neural-pathway that allows the natural matrix controllers to learn other powers. The scientist soon disappeared after making his statement known. It has yet to be substantiated.

## SURVIVAL MATRIX ROLLS

Due to the nature of some powers, the targeted individual must make a Survival Matrix Roll to determine the extent to which the power has an affect. A successful SMR can negate or attenuate the effect of the power. Some powers don't permit an SMR. Whether or not an SMR is applicable, is stated within the power description. Unless otherwise stated, SMR's are reduced by 03% per level of skill of the MC above the initial possible learning point of the matrix

## CHATILIAN POWERS

1 POWER POINT	2 POWER POINTS	3 POWER POINTS
1). Clairaudience	Berserk	Distance Illusion
2). Clairvoyance	Confusion	Feign Death
3). Concentration	Disposition	Image Creation
4). Comprehend Lang	Ego Whip	Invisibility
5). Enrage	Image Projection	Mind Blank
6). ESP	Mind Dive	Mind Strangle
7). Fear	Prisoner	Pain
8). Offering	Psychometry	Sonic Immunity
9). Patience	Sleep/Alert	Memory Storage
10). Psycho-Kinesis	Strength	True Sight
11). Stun	Subliminal Implant	
12). Summoning 1	Trust	
13). Telepathy		
14). Telepathy (animal)		
15). Telepathy (plant)		

4 POWER POINTS	5 POWER POINTS	6 POWER POINTS
1). Communique	Chaos	Focus
2). Ego Smash	Crom's Warrior	Haunt
3). Hypnotic Trance	Death Vision	Link
4). Mass Fear	Dimension Travel	Mass Paralysis
5). Mass Friendship	Mind Projection	Resonant Structure
6). Negation	Permanent Illusion	Soul Binder
7). Pass Unnoticed	Summoning 2	Soul Search
8). Psychic Emulsion		Summoning 3
9). Speak With Dead		Vanquish
10). Trade Minds		
11). Triok's Invulnerability		

7 POWER POINTS	8 POWER POINTS	9 POWER POINTS
1). Astral Travel	Future Shock	Supreme Resonance
2). Body Switch	Psychic Force	
3). Disciple	Steal Soul	
4). Scry		
5). Vision Quest		

## MUTZACHAN POWERS

1 POWER POINT	2 POWER POINTS	3 POWER POINTS
1). Chilled Veins	Battery	Activation Energy
2). Darkness	Bypass	Displacement
3). Electrical Dis.	Continuous Light	Fire Blast
4). Finger Laser	Drain	Fly
5). Glue	Ground Sparks	Frequency Scanner
6). KE Barrier	Invisibility	Optical Reduction
7). Light	Jam	Sonic Concussion
8). Metal Detection	Magnetize	Sonic Immunity
9). Pyrotechnics	Polymizer	Transmission Boost
10). Shatter	Short Circuit	Transmission Jam
11). Separation	Ultra-Vision	Transmission
12). Shadow Boxer	Warp Metal	Scrambler
13). Spot Weld		
14). Temperature Manipulation		

4 POWER POINTS	5 POWER POINTS	6 POWER POINTS
1). Cellular Disruption	Combination	Anti-Gravity
2). Cellular Immunity	Dimension Travel	Energy Negation
3). Energy Manipulate	Fire Wall	Kashonas
4). Explosive Lattices	Flux Shield	Life Shield
5). Plasma Reduction	Ice Wall	Solar Sail
6). Plasma Pulse	Kinetic Immunity	Space Walk
7). Power Reservoir	Molecular Disrupt	Time Slow
8). Psionic Immunity	Molecular Dispersion	
9). Shape	Omega Pulse	
10). X-Ray Vision	Power Port	
11).	Radiation Shield	
12).	Teport	

7 POWER POINTS	8 POWER POINTS	9 POWER POINTS
1). Attraction/Repuls.	Bind	Combination
2). Cancellation	Cataclysm	Space Fold
3). Energy Cloud	Gravity Wave	Time Travel
4). Mass Teleport	Nova	
5). Permanency	Worm Hole	

## ZEN RIGELN POWERS

1 POWER POINT	2 POWER POINTS	3 POWER POINTS
1). Awaken	*Achilles Heel	Assizzian Palm
2). Benign	Burns	*Blind
3). Blessing	Cosmetic Surgery	Cure Disease
4). Blood Stoppage	*Cramps	Death's Door.
5). *Calcify	Geiger Counter	*Essence Drain
6). Clarity	Heal Plants	Identify Agent
7). Fear	Internal Bleeding	Mend Bones (skull)
8). Mend Bones (simple)	Methalizer	Mind Healing
9). *Pain	Mend Bone (comp)	*Paralysis
10). Plant Sentience	Need	*Parasitic Infest.
11). Purification	Poison Removal	*Protein Coagulant
12). Ritual of Peace	Probe	Remove Paralysis
13). Slow Poison	*Reverse Peristalsis	Speak With Dead
14). Sterilize	Sterilize Environ.	Sonic Immunity
15). White Count		*Strangulation

4 POWER POINTS	5 POWER POINTS	6 POWER POINTS
1). Age	Alter Visage	Cryogenic Freeze
2). Animate Dead	Calling of Tashim	Enshrinement
3). *Cellular Disruption	*Cancer	Entombment
4). Cellular Immunity	Cure Amnesia	*Famine
5). *Deform	*Disembowel	Mass Healing
6). Divine Assistance	*Essence Transfer	Palthison
7). Embalm	Exorcism	Raise Dead
8). *Ectoplasm	*Heartless	Regenerate limb
9). Heal	Mother's Milk	
10). Heavy Sleep	Touch Subconscious	
11). Insta-medic	Zashmil	
12). *Leprosy		
13). Mind Shield		
14). *Muscular Dystrophy		
15). Radiation (lethal)		
16). Ward of Assizza		

7 POWER POINTS	8 POWER POINTS	9 POWER POINTS
1). Alter Form	Clone	Ra
2). Death's Crossing	*Plague	
3). Disciple	*Power of the Tza	
4). Implant	Reincarnate	
5). Soul Savior		
6). Temple of Healing		

\* Tza Zen ONLY!!!

## EMPATH ADVANCEMENT TABLE

LEV	EXP PTS	CRYSTAL PTS	TITLE	COST
1	001-1000	Tiger's Eye 1	Receiver	1000
2	1001-3000	Tiger's Eye 1	Sender	1000
3	3001-5000	Tiger's Eye 1	Communicator	1000
4	5001-8000	Bloodstone 2	Telepath	2000
5	8001-12,000	Bloodstone 2	Psychic	2000
6	12,001-18,000	Bloodstone 2	Mentalist	2000
7	18,001-28,000	Zircon 3	Visionary	5000
8	28,001-40,000	Zircon 3	Seer	5000
9	40,001-60,000	Zircon 3	Empath	5000
10	60,001-90,000	Amber 4	1st Circle of Power	10000
11	90,001-150,000	Amber 4	2nd Circle of Power	10000
12	150,001-240,000	Amber 4	3rd Circle of Power	10000
13	240,001-420,000	Sapphire 5	1st Tier of Power	25000
14	420,001-700,000	Sapphire 5	2nd Tier of Power	25000
15	0.70M-1.1M	Sapphire 5	3rd Tier of Power	25000
16	1.1-2.0M	Emerald 6	1st Tower of Power	50000
17	2.0M-3.5M	Emerald 6	2nd Tower of Power	50000
18	3.5M-6.0M	Emerald 6	3rd Tower of Power	50000
19	6.0M-8.5M	Ruby 7	Lord of Vision	100000
20	8.5M-11.0M	Ruby 7	Lord Empathy	1000000
21	11.0M-13.5M	Ruby 7	Lord of Power	1000000
22	13.5M-16.0M	Diamond 8	Lord of Might	5000000

## HENRY THE MUTZACHAN WAS HERE!!!!

## ENERGY CONTROLLER ADVANCEMENT

LEV	EXP PTS	COLOR	PTS	TITLE	COST
1	0001-1000	White	1	Electron Controller	1000
2	1001-2500	White	1	Proton Controller	1500
3	2501-5000	White	1	Neutron Controller	2000
4	5001-9000	Yellow	2	Alpha Controller	4000
5	9001-15,000	Yellow	2	Beta Controller	6000
6	15,001-20,000	Yellow	2	Gamma Controller	8000
7	25,001-40,000	Green	3	Meson Controller	10000
8	40,001-62,500	Green	3	Particle Controller	13000
9	62,001-80,000	Green	3	Light Controller	16000
10	80,001-110,000	Blue	4	Magnetic Controller	20000
11	110,001-170,000	Blue	4	Field Controller	25000
12	171,001-300,000	Blue	4	Ion Controller	30000
13	300,000-600,000	Red	5	Radiation Controller	40000
14	600,001-1. 0M	Red	5	Flux Controller	50000
15	100,0001-1.5M	Red	5	Force Controller	60000
16	1.5M-2.5M	Brown	6	Power Controller	80000
17	2.5M-5.0M	Brown	6	Systems Controller	100000
18	5.0M-7.5M	Brown	6	High Controller	120000
19	7.5M-10.0M	Black	7	Sun Mage	140000
20	10.0M-12.5M	Black	7	Stellar Mage	160000
21	12.5M-15.0M	Black	7	Solar Mage	200000
22	15.0M-17.5M	Silver	8	Galactic Mage	220000
23	17.5M-20.0M	Silver	8	Quadrant Mage	240000
24	20.0M-22.5M	Silver	8	High Mage	260000
25	22.5M-25.0M	Gold	9	3rd Seat of Council	280000
26	25.0M-27.5M	Gold	9	2nd Seat of Council	300000
27	27.5M+	Gold	9	1st Seat of Council	500000

## HEALER ADVANCEMENT TABLE

LEV	EXP PTS	COLOR	PTS	TITLE	COST
1	001-750	White	1	Novice	500
2	751-2000	White	1	Feeler	500
3	2001-4000	White	1	Sensor	500
4	4001-7000	Cerulean	2	Follower	1500
5	7001-12,000	Cerulean	2	Believer	1500
6	12,001-20,000	Cerulean	2	Teacher	1500
7	20,001-34,000	Magenta	3	Of the Body	4000
8	34,001-55,000	Magenta	3	Of the Mind	4000
9	55,001-85,000	Magenta	3	Of the Soul	4000
10	85,001-130,000	Turquoise	4	The Shaper	8000
11	130,001-200,000	Turquoise	4	The Mender	8000
12	200,001-310,000	Turquoise	4	Healer	8000
13	310,001-650,000	Beige	5	Bishop	16000
14	650,001-1.2M	Beige	5	Savior	16000
15	1.2M-2.2M	Beige	5	Saint	16000
16	2.2M-4.0M	Maroon	6	His Grace	32000
17	4.0M-7.0M	Maroon	6	His Lordship	32000
18	7.0M-9.5M	Maroon	6	His Majesty	32000
19	9.5M-12.0M	Cyan	7	Hand of Assizza	64000
20	12.0M-14.5M	Cyan	7	Heart of Assizza	64000
21	14.5M-16.0M	Cyan	7	Voice of Assizza	64000
22	16.0M-20.0M	White	8	Soul of Assizza	128000
23	20.0M-25.0M	White	8	Mind of Assizza	128000
24	25.0M-30.0M	White	8	Body of Assizza	128000
25	30.0M+	Transparent	9	Assizza	250000

## EMPATH POWERS

### 1 POWER POINT

#### Clairaudience

Generation Time: 2 sec	Range: 100m
Boost: 1 min/point	Duration: 1 min
SMR: None	Area of Effect: Target

The Chatilian focuses on his hearing sense. He can detect the movement of a man-sized creature out to 100m. It increases hearing checks by +50.

#### Clairvoyance

Generation Time: 2 sec	Range: 1000m
Boost: 1 min/point	Duration: 1 min
SMR: None	Area of Effect: Target

This matrix functions exactly like clairaudience, except the empath focuses his sight sense. It increases sighting checks by +50. It is useful out at spotting size class 4 objects out to 1000m.

#### Concentration

Generation Time: 1 sec	Range: Touch
Boost: None	Duration: 2 min
SMR: None	Area of Effect: None

The empath attempts to block out all extraneous noise and distractions in order to focus more clearly on the task at hand. The base percentage chance to perform any task is increased by 15 percentage points. The Empath gains an additional 02% percent concentration bonus per level of skill above 1st.

#### Comprehend Languages

Generation Time: 1 sec	Range: 5m
Boost: 1 min/point	Duration: 2 min
SMR: None	Area of Effect: Target

The empath is able to understand the spoken language of another person through the use of limited telepathy. Comprehend languages also allows the empath to understand the written word. At no time does using this matrix confer upon the individual the ability to actually write the language.

#### Enrage

Generation Time: 2 sec	Range: Touch
Boost: 10 sec/point	Duration: 10 sec
SMR: None	Area of Effect: Target

The target becomes so angry and aggressive that he or she outwardly seeks combat. Enraged combatants gain 2-8 temporary body points and a +1 to damage dice (archaic hand held weapons only).

#### ESP

Generation Time: 1 sec	Range: 20m.
Boost: 10m/point	Duration: 1 min
SMR: Mental	Area of Effect: Target

E.S.P. stands for extra sensory perception. This matrix enhances the empath's natural ability to read the surface thoughts of another. This power is stopped by 10cm of metal or 0.7m of rock. The target receives an SMR vs mental attacks. Success indicates failure in the attempt to read his mind. He or she may also be AWARE that you tried (50%).

#### Fear

Generation Time: 1 sec	Range: 5m
Boost: 5m/point	Duration: 2-8 min
SMR: Mental	Area of Effect: 5 Targets

The empath attempts to frighten people. He may attempt to frighten up to 5 targets at a cost of 1 power point per creature to be affected. Targeted beings receive a SMR vs mental attack forms. Those who fail their SMRs flee in panic. Those who succeed are unaffected.

#### Offering

Generation Time: 3 sec	Range: 7m.
Boost: 1 min/point	Duration: 2-8 min
SMR: Mental	Area of Effect: Target

At times an empath will wish to make an offering of friendship to someone or something. The Chatilian generates this matrix and the target individual sees the item to be offered as something of high value. The empath may be holding a rock. It might appear to be a precious gem. Target individuals will remain friendly toward the empath until the effects of the matrix wears off. If the target makes his SMR, he sees the gift as it truly is.

#### Patience

Generation Time: 2 sec	Range: Touch
Boost: 30 sec/point	Duration: 1 min
SMR: None	Area of Effect: Target

The empath forces his body to completely relax. The Chatilian is no longer agitated and becomes calm. He can monitor the events around him with an almost aloof detachment. He gains a -2 to initiative rolls.

#### Psycho-Kinesis

Generation Time: 10 sec	Range: 30m.
Boost: 2kg/point	Duration: 2 min
SMR: None	Area of Effect: 10kg

The empath is able to move objects with his mind. He can move an object that weighs 30kg or less a distance up to 30m. The object begins moving slowly and picks up speed.

#### Stun

Generation Time: 1 sec	Range: 3m
Boost: 2m/point	Duration: 1-6 min
SMR: Mental	Area of Effect: Target

The Chatilian attempts to stun an individual and temporarily render him unconscious. The controller need not touch the target, but must be within the range limitations of the matrix. A successful SMR negates the attack, while failure indicates that the target individual has been struck "loopy". Example: Ernie, the Empath, wishes to stun Fredd the Python who is standing 5m away. Ernie must expend 2 power points to attempt the stun.

#### Summoning 1

Generation Time: 10 sec	Range: 0
Boost: None	Duration: Special
SMR: Special	Area of Effect: 100m radius

All creatures with an intelligence of 30 or less in the surrounding area will home in on the empath's thoughts and immediately come to the area (Ram Pythons included)! The disposition of the summoned creatures will not necessarily be of friendly nature. They will however, answer the homing beacon.

#### Telepathy

Generation Time: 1 sec	Range: 10m.
Boost: 5min/point	Duration: 2 min
SMR: None	Area of Effect: 5 Targets

This particular matrix confers upon the empath the ability to communicate via mind link with another "willing" individual. No verbal expression is needed. The controller and the individual are able to have a normal conversation, without the use of words or semantics. The empath cannot read thoughts that are not sent.



E



## Special Powers

### Telepathy (animal)

Generation Time: 1 sec      Range: 10m.  
Boost: 5min/point      Duration: 2 min  
SMR: None      Area of Effect: 5 Targets

This ability allows the empath to communicate with intelligent animals. It functions exactly like telepathy.

### Telepathy (plant)

Generation Time: 1 sec      Range: 10m.  
Boost: 5min/point      Duration: 2 min  
SMR: None      Area of Effect: 1 Targets

This matrix allows the empath to communicate with sentient plants. Otherwise it is identical to telepathy.

## 2 POWER POINTS

### Berserk

Generation Time: 1 sec      Range: Touch  
Boost: None      Duration: 1-4 min  
SMR: Mental      Area of Effect: Target

The target individual becomes dangerously violent and attacks without fear of bodily harm. The empath can focus the berserker's rage toward a specific being. See combat section for the effects of berserk.

### Confusion

Generation Time: 2 sec      Range: 0  
Boost: 1 min/point      Duration: 1-4 min  
SMR: Mental      Area of Effect: 10m radius

The Chatilian disrupts the cognitive thought processes of all targets within the confines of the matrix. All affected persons become completely confused and will act randomly. SMR are decreased by 02% per level of skill above 4th.

### Disposition

Generation Time: 2 sec      Range: 20m.  
Boost: 10m/point      Duration: Instantaneous  
SMR: None      Area of Effect: Target

This matrix confers upon the controller the ability to determine the basic disposition of the target. The MC can only determine the basic alignment.

### Ego Whip

Generation Time: 2 sec      Range: 20m.  
Boost: -03 mod/point      Duration: 1-4 min  
SMR: Mental      Area of Effect: Target

Ego Whip is used to batter the target's ego into submission. Affected persons sink into a state of manic depression and do not fight. This matrix can be increased in strength. Each additional power point of boost creates a -03 to SMRs vs mental attack forms.

### Image Projection

Generation Time: 1 sec      Range: Body centered  
Boost: None      Duration: 15 sec  
SMR: Mental      Area of Effect: 50m radius

The empath attempts to disrupt the visual organs of those around him by projecting multiple images of himself. 1-4 such images can be created. Affected creatures do not know which one is the real empath. Randomly determine if successful attacks hit the MC or one of the images. Creatures who aren't affected, see only a vulnerable empath, just waiting to be taken out. The images last for 15 seconds.

### Mind Dive

Generation Time: 10 sec      Range: Touch  
Boost: None      Duration: Special  
SMR: None      Area of Effect: Target

Generating this matrix bestows the ability to dive into the subconscious mind of another. The empath will be able to read the subconscious thoughts of the target individual.

**Example:** Our friend Ernie the Empath might dive into the mind of George the Gen-Human to extract a message that was implanted there.

### Prisoner

Generation Time: 4 sec      Range: 20m  
Boost: 10m/point      Duration: 2-8 min  
SMR: Mental      Area of Effect: Target

The empath attempts to create an illusion in the mind of the target individual. Those who fail their SMR believe themselves to be imprisoned in a fortress of bars and steel with no hope of escaping. Affected creatures merely sit down in submission.

### Psychometry

Generation Time: 10 sec      Range: Touch  
Boost: None      Duration: Special  
SMR: None      Area of Effect: Target

Psychometry is the ability to determine the nature of past events by touching an object that was used in the events. The Chatilian has a base 40% chance to determine information about the event by touching the object. This chance increases at a rate of 03% per level of skill above the 4th.

### Sleep/Alert

Generation Time: 1 min      Range: Self  
Boost: 1 hr/point      Duration: 2hr  
SMR: None      Area of Effect: Self

This matrix places the empath's conscious mind in deep slumber, while at the same time raising his perception senses. The Chatilian sleeps soundly, yet the slightest disturbance will immediately awaken him. Furthermore, he will react with such speed that he does not suffer initiative penalties in the following combat segment.

### Strength

Generation Time: 2 sec      Range: Touch  
Boost: None      Duration: 1-6 min  
SMR: None      Area of Effect: Target

This matrix raises the strength of the target individual by 25%, to a maximum of 150.

### Subliminal Implant

Generation Time: 4 sec      Range: 20m.  
Boost: None      Duration: Special  
SMR: None      Area of Effect: Target

The empath is able to plant a message in the subconscious mind of the person. The target won't be aware that the message has been implanted at all. The message can be no longer than 15 words. The person merely becomes a storage bank. The message remains lodged in the subconscious until extracted.

### Trust

Generation Time: 2 sec      Range: 20m.  
Boost: 2 min/point      Duration: 1-4 min  
SMR: Mental      Area of Effect: Target

This is a useful matrix which can be employed to gain the trust of another. Anyone who fails his SMR trusts the empath completely.

### 3 POWER POINTS

#### Distance Illusion

Generation Time: 1 sec      Range: 50m.  
 Boost: None                      Duration: Not Applicable  
 SMR: Mental                      Area of Effect: 100m radius

Distance Illusion is one of the first illusionary matrices taught to the empath. When generated, it creates the illusion of the empath retreating at a high rate of speed, when in actuality the empath is advancing. All attempts by those within the area of effect to fire upon the empath automatically fail. Those who make a successful SMR see what is actually happening. On subsequent fire segments, they can warn those around them of the illusion. Warned beings receive a +20 to subsequent SMRs. SMRs are reduced at 04% per level of the empath above 7th.

#### Feign Death

Generation Time: 10 sec      Range: Self  
 Boost: 5 min/point              Duration: 10 min  
 SMR: None                      Area of Effect: Self

Through intense concentration, the matrix controller lowers the rate of his bodily functions. His respiratory and circulatory systems slow to the point of almost stopping. He appears dead, yet is completely aware of events that transpire around him. He can leave this state at any time. The empath may increase the duration of the matrix by adding a point of power per 5 minutes of death.

#### Image Creation (minor)

Generation Time: 30 sec      Range: 10m  
 Boost: None                      Duration: 1 min  
 SMR: Special                    Area of Effect: 20 cubic meters

This matrix is generated to create an illusion. All creatures with an intelligence of less than 30 automatically believe it. All creatures with an intelligence of greater than 30 receive an SMR vs mental attack forms. The illusion has only visual components and does not move. An empath could, for example, create the illusion of a pit. He could not, however, create the illusion of an attacking Space Troll.

#### Invisibility

Generation Time: 2 min      Range: Self  
 Boost: 1min/point              Duration: 5 min  
 SMR: Special                    Area of Effect: 50m radius

The invisibility matrix affects the eyes of all targets within the area of effect. Unwary persons do not see the matrix controller. He is free to move about for five minutes. For every additional minute, the empath must expend one extra power point. Only those who have some reason to suspect the invisible empath's presence receive a mental SMR.

#### Mind Blank

Generation Time: 5 sec      Range: Self  
 Boost: 1 min/point              Duration: 2 min  
 SMR: None                      Area of Effect: Self

When an empath generates this matrix, he is able to block out all mind probe attempts. He creates a mind shield that can't be penetrated by any means. Truth serums are ineffective as well as all other forms of mental attack. The duration can be increased by adding additional power points.

#### Mind Strangle

Generation Time: 5 sec      Range: 10m  
 Boost: 5m/point                  Duration: 1hr  
 SMR: Mental                    Area of Effect: Target

The Chatilian attempts to enter the targeted individual's mind and block all conscious thought. Success indicates that the victim's mind has been temporarily strangled. The affected person lapses into a deep catatonic state and can not move, think, or act at all. Bodily functions continue. The victim has no idea of the events that transpire while he is "blacked out."

#### Pain

Generation Time: 2 sec      Range: 10m  
 Boost: None                      Duration: 1-6 min  
 SMR: Mental                    Area of Effect: Target

The empath makes a mental assault on the sensory nerves of the target individual. The person is instantly racked with body pains and becomes prostrate for the duration of the matrix. He performs actions at a -60 penalty.

#### Sonic Immunity

Generation Time: 5 sec      Range: Touch  
 Boost: 1 min/point              Duration: 5 min  
 SMR: None                      Area of Effect: Target

The person becomes immune to all sonic attack forms for as long as the matrix is employed.

#### Memory Storage

Generation Time: 15 min      Range: Touch  
 Boost: None                      Duration: Special  
 SMR: None                      Area of Effect: Target

Memory Storage can only be generated on dying individuals. When the empath generates this matrix, he absorbs the thoughts of the victim into the subconscious of his mind. The empath isn't able to utilize the information stored, but can retain it indefinitely. Should some means be obtained to return the victim's body to life, the empath can reverse the process and re-implant the memories and cognitive processes. The empath can only store one person's memories at a time.

#### True Sight

Generation Time: 1 sec      Range: Self  
 Boost: 1min/point              Duration: 1 min  
 SMR: None                      Area of Effect: Line of sight

This matrix provides true sight. The MC will know which images are illusions or holographic images.

### 4 POWER POINTS

#### Communique

Generation Time: 3 sec      Range: 0  
 Boost: 1min/point              Duration: 2 min  
 SMR: None                      Area of Effect: 400m radius

Communique allows the MC and all friendly persons to communicate amongst themselves without having to speak. The empath concentrates on the persons that he wishes to join the private line.

#### Ego Smash

Generation Time: 2 sec      Range: 0  
 Boost: None                      Duration: 4-16 min  
 SMR: Mental                    Area of Effect: 10m radius

When generated, all persons within the area immediately fall into the deepest state of self hatred. The matrix controller seeks to batter the ego into utter submission, destroying the victim's self esteem and desire to live. Those who fail their SMR have a base chance to attempt suicide equal to the difference between the roll needed to survive against the matrix and the actual dice roll.

## Special Powers

**Example:** Ernie the Empath generates an Ego Smash against Fred the Python. Fred has an SMR vs mental attack forms of 45. Fred rolls a 55. The percentage chance to commit suicide is 10%. The dice are rolled! Fred gets a 08%! He grabs a couple of frag grenades and pops them into his mouth like candy. Boom! Boom! What will we say to his mother?

Those who make a successful SMR receive a -10 penalty to all attacks and task attempts for the duration of the matrix.

### Hypnotic Trance

Generation Time: 3 sec      Range: 0  
Boost: None                      Duration: 1-6 min  
SMR: Mental                      Area of Effect: 50m radius

This matrix causes all individuals who fail their matrix rolls to be locked in a hypnotic trance. They see a shimmering of beautiful and alluring colors which keeps them bound for the duration of the matrix, unless someone comes along and breaks the trance. A mere slap will not awaken the person. You have to pound on him for a while.

### Mass Fear

Generation Time: 10 sec      Range: 0  
Boost: None                      Duration: 2-8 min  
SMR: Mental                      Area of Effect: 50m rad.

This matrix is designed to inspire fear in the minds of the empath's enemies. Those who fail their SMR vs mental attack forms, automatically flee. Fear struck individuals run for 2-8 minutes.

### Mass Friendship

Generation Time: 10 sec      Range: 0  
Boost: None                      Duration: 1-6 hr  
SMR: Special                      Area of Effect: 50m

The empath emits an aura of friendship. All beings with an intelligence less than 40 automatically succumb to the effects. Persons with I.Q. scores greater than 40 receive an SMR. Those who fail their SMRs are quite friendly toward the empath. Victims will even defend their new buddy. They won't, however, kill themselves.

### Negation

Generation Time: 10 sec      Range: Touch  
Boost: None                      Duration: Permanent  
SMR: None                      Area of Effect: Target

Negation wipes out the effects of any mental attack form. Stricken individuals are returned to their natural state of being. NOTE: Negation doesn't reverse the effects of matrices that do real damage.

### Pass Unnoticed

Generation Time: 5 min      Range: 0  
Boost: 1 min/point              Duration: 5 min  
SMR: Special                      Area of Effect: 10m radius

The matrix controller disrupts the sensory organs of enemy personnel. He and anyone within a 10m radius of his person can pass unnoticed. Only persons who suspect the matrix controller's presence - and none of their senses will detect him - receive an SMR. Note that in order to suspect his presence, enemies must have detected the empath before the matrix took effect.

### Psychic Emulsion

Generation Time: 2 sec      Range: 20m.  
Boost: -02 SMR/point          Duration: Permanent  
SMR: Mental                      Area of Effect: Target

The empath assaults the target's mind. The victim receives an SMR. Those who fail lose 2-8 points of I.Q. permanently.

### Speak With Dead

Generation Time: 5 sec      Range: 5m  
Boost: None                      Duration: 5 min  
SMR: None                      Area of Effect: Target

When an empath utilizes this matrix, he calls out to the soul of someone who is dead. If the soul has remained in the area, it will return and communicate to the empath through telepathic means. It will respond to the empath as it would if it were still alive. The empath cannot force the being to speak nor can he be sure it will not lie to him. There is a 100% chance that the soul will be in the area if the victim has died within 2 days, 75% within 4 days, 50% within 10, and 25% if greater than 10.

### Trade Minds

Generation Time: 10 min      Range: Special  
Boost: 30 min/point              Duration: 4 hr  
SMR: None                      Area of Effect: Special

This matrix confers upon the empath the ability to trade minds with a WILLING individual for the duration of the matrix.

### Triok's Invulnerability

Generation Time: 2 sec      Range: Touch  
Boost: None                      Duration: 2-8 min  
SMR: None                      Area of Effect: Target

Triok was a powerful matrix controller who discovered the invulnerability matrix. When the empath generates this matrix, he sends a powerful subliminal message to the recipient. That individual believes that he is invincible. The body's pain sensors are blocked and so he feels no pain. He gains 4-16 temporary body points. Furthermore, the recipient can fight up until the point where he dies (i.e. -10 body points for most). Wounds will have little effect on his enthusiasm, nor does the sight of his own blood.

## 5 POWER POINTS

### Chaos

Generation Time: 2 min      Range: 0  
Boost: 15 sec/point              Duration: 10 min  
SMR: Mental                      Area of Effect: 500m squared

Total chaos is created in all individuals who fail their respective matrix rolls. They move randomly and attack each other. The duration of the matrix can be increased by adding 1 additional power point of power per 15 seconds of effect.

### Crom's Warrior

Generation Time: 5 sec      Range: 200m  
Boost: None                      Duration: 5 min  
SMR: None                      Area of Effect: Special

Crom was a powerful Illuminary during the Totalitarian Inquisition. The Illuminaries had sought refuge from the hunters in the Caves of the Dark. While in exile, Crom sought to contact an "external force" to aid his people when the time came for the final battle. In his search he contacted an entity now known as Crom's Warrior. The entity takes corporeal form as a 4 meter tall skeleton, clad in plate mail armor. The skeleton has red, fiery eyes. It wields a great battle axe that does 4-16 points of damage per attack. The warrior has 200 body points and attacks with skill equal to 1/2 of the empath's level. The warrior will only obey the commands of the empath who has summoned him into service. Base chance to hit: 80%.

### Death Vision

Generation Time: 1 sec      Range: 100m  
Boost: None                      Duration: Special  
SMR: Mental                      Area of Effect: Target

Death Vision is a powerful Chatilian matrix. The empath creates a nightmarish image of horrific proportions. The victim sees his own death in the most violent and feared fashion of his dreams. He has a massive coronary and dies on the spot. The matrix is so strong that victims save at a -10 to SMRs. Those who save are shaken, but realize that the vision isn't real. They do, however, function at a -40 when performing any type of task for the next 4-40 minutes. SMRs are further reduced by 04% per level of the MC above 13th.

#### Dimension Travel

Generation Time: 1 min	Range: Special
Boost: 5 min/point	Duration: 1 hr
SMR: None	Area of Effect: Special

When an empath generates this matrix, he or she is able to travel to the fourth dimension and speak with entities there. The empath temporarily leaves his body behind. The type of spirits encountered depends on the location of the out of body experience.

#### Mind Projection

Generation Time: 1 min	Range: 2000m
Boost: 5 min/point	Duration: 1 hour
SMR: None	Area of Effect: None

This requires an enormous amount of inner strength. The empath temporarily leaves his body and travels to some desired place. The empath's mind exists as energy, yet he is capable of hearing, smelling, etc. The empath is able to view events, while in this out of body state, but can not interact. Walls and solid barriers have no effect on his movement, since he exists merely as energy. The duration of the matrix can be increased by expending 1 power point per additional 5 minutes of the out of body experience.

#### Permanent Illusion

Generation Time: 10 min	Range: 100m
Boost: None	Duration: Permanent
SMR: Special	Area of Effect: 100m cubed

A powerful empath is able to create an illusion that is permanent. The illusion will only have visual form, but remains forever, unless it is dispelled. Individuals encountering the illusion believe it to be real, unless the illusion is grossly out of place, in which case they receive an SMR vs mental attack forms. Those who are immune to the effects of illusions automatically see things as they truly are.

#### Summoning 2

Generation Time: 3 sec	Range: 0
Boost: None	Duration: 5 min
SMR: Special	Area of Effect: 400m radius

Same as the basic summoning 1 ability, but creatures under 50 intelligence automatically answer the summoning. 5-30 creatures are affected.

## 6 POWER POINTS

#### Focus

Generation Time: 1 min	Range: Special
Boost: 10 min/point	Duration: 1 hr
SMR: None	Area of Effect: Target

Focus blocks out all extraneous noise and distractions. Individuals gain a +100 to all skill tasks, +35 for weapons tasks while the matrix lasts.

#### Haunt

Generation Time: 30 min	Range: Special
Boost: None	Duration: 7 day
SMR: None	Area of Effect: Special

This matrix is utilized to summon an evil, minor entity from the fourth dimension. The spirit responds to the summoning and does the bidding of the empath. The entity will haunt the intended victim for 7 days and nights. It will torture the dreams of the victim. During the day, the victim will believe that he is constantly being watched, and will become more and more convinced that he is going to die at the hands of the spirit. The victim's physical condition will deteriorate over time. There is 10% cumulative chance per night that the victim will suffer a coronary and die. The haunt can be slain by normal means (40 body points). It is visible in the ultraviolet spectrum.

#### Link

Generation Time: 2 min	Range: Touch
Boost: None	Duration: Special
SMR: None	Area of Effect: Special

The empath creates a mind link with any other matrix controller. The mind link boosts the power of the other's matrix, conferring upon him triple strength to all his powers. There is some danger associated with this matrix. If the other MC generates a matrix of higher level than he can normally generate, there is a 05% chance per level of difference between the two that the matrices will overload and backfire. The other MC takes 4-24 points of damage, and the empath's head detonates splattering goop everywhere!!!

#### Mass Paralysis

Generation Time: 2 sec	Range: 1000m
Boost: None	Duration: Permanent
SMR: Mental	Area of Effect: 100m

One of the most useful and deadly matrices. The empath permanently disrupts the sensory neurons of all targets within the area of effect. Those who fail their SMRs are paralyzed for life, unless the condition is dispelled. (The paralysis is from fear, and is not complete. It is only from the eyeballs down).

#### Resonant Structure

Generation Time: 5 sec	Range: 200m
Boost: None	Duration: 10 sec
SMR: Special	Area of Effect: 10m radius

The empath creates a resonant wave inside the skull of all creatures within the targeted area. The wave resonates up to the harmonic frequency of the skull. The skulls explode. There is no normal SMR, but those targets wearing full face helmets have a 50% chance to negate the matrix. Sonic protection is also effective against this attack. Add any SMR bonus vs sonics to the roll.

#### Soul Binder

Generation Time: 10 sec	Range: Touch
Boost: 30 min/point	Duration: 4 hr
SMR: None	Area of Effect: Target

This matrix temporarily keeps a victim's dying soul in his body. If medical treatment can be offered within 4 hours, the victim will live. The empath can increase the duration of the matrix by adding 1 power point per additional 30 minutes needed.

#### Soul Search

Generation Time: 10 min	Range: Special
Boost: 1 hr/point	Duration: 1 day
SMR: Mental	Area of Effect: Self

The empath's mind enters and moves about in the 4th dimension. While in the 4th dimension, the MC acts as a homing beacon for the soul that he is seeking out. The soul must make an SMR vs Mental attacks or answer the beacon. The MC may move freely for the duration of the matrix.

## Special Powers

### Summoning 3

Generation Time: 1 hr      Range: Special  
Boost: None                      Duration: Instantaneous  
SMR: None                        Area of Effect: One being

This matrix allows the empath to summon minor entities from the 4th dimension. The type of being that responds to the summoning is random. (*Editors' Note: If you ever get this power, tell your BM that he has to make these up. It's in the rules.*)

01-30 Masug  
31-50 Demon Morg  
51-70 Bashik  
71-80 Death Dragon  
81-100 Tabak

### Vanquish

Generation Time: 15 sec      Range: Special  
Boost: None                      Duration: Instantaneous  
SMR: Special                    Area of Effect: Target

The Chatilian generates this matrix to send an entity back to the fourth dimension. The base chance of success is 85% for a minor entity and 50% for a major entity. This increases 04% per level of experience above 16th.

## 7 POWER POINTS

### Astral Travel

Generation Time: 1 sec      Range: 10 parsecs  
Boost: 1 parsec/3 points      Duration: Instantaneous  
SMR: None                        Area of Effect: Self

When an empath reaches the 7th bracket of energy control, he becomes vastly more powerful. In dire situations, he may have need to transport himself to safety with little notice. The astral travel matrix allows the MC to cross over into a parallel universe and travel instantly to a place, then cross back into his own universe. He can cross 20 parsecs of space instantly. This matrix drains 5 constitution points permanently.

### Body Switch

Generation Time: 30 sec      Range: Special.  
Boost: None                      Duration: 2 days  
SMR: None                        Area of Effect: Special

The empath is able to hold an individual's dying soul until the soul can be placed into another body. The empath links with the soul and then must set out to find another body. If the empath can find a body within 2 days, he can save the soul by creating a mental conduit for the soul to cross into the body. There is a mental SMR for pushing the soul out.

### Disciple

Generation Time: 1 hr      Range: Touch  
Boost: None                      Duration: Special  
SMR: None                        Area of Effect: Target

A powerful empath may wish to empower a disciple to take his place, in the event of his untimely death. He can implant any or all of his known powers into the subconscious mind of his student and can then set a biological clock or some other mechanism to trigger the knowledge. Once triggered, the young MC has complete control over the matrices.

### Scry

Generation Time: 1 min      Range: 10 parsecs  
Boost: 2 parsec/point      Duration: 5 min  
SMR: Special                    Area of Effect: Special

This matrix allows the empath to observe another from a great distance. The chance for success, depends on how well the empath knows the one he seeks to observe.

Unknown: 05%  
Acquainted: 20%  
Familiar: 50%  
Close: 75%  
Intimate: 90%

The chance for success is also increased by 04% per level of the controller above 19th.

### Vision Quest

Generation Time: 5 sec      Range: Special  
Boost: None                      Duration: Special  
SMR: None                        Area of Effect: Special

The empath is empowered to look back through time and observe events. He may not participate or affect them in any way. The empath must be familiar with the location and time of the occurrence. The chance for success equals:

Unknown: 00%  
Unfamiliar: 10%  
Familiar: 25%  
Well Informed: 40%  
Expert: 50%

The chance for success is also increased by 04% per level of the controller above 19th.

## 8 POWER POINTS

### Future Shock

Generation Time: 1 min      Range: Special  
Boost: None                      Duration: 10 min  
SMR: None                        Area of Effect: Special

This matrix allows the MC to get a glimpse of a possible future. The base chance for success equals 100%. For every week into the future, the chance is reduced by 01%. That which is observed is 25% likely to be correct. The empath is able to observe the events of a possible future, but he can in no way affect it during the viewing.

### Psychic Force

Generation Time: 1 min      Range: 100km  
Boost: None                      Duration: Instantaneous  
SMR: None                        Area of Effect: Target

The empath can create a psychic blast of incredible proportions. It does 100-400HP of damage. A high level empath on the bridge of a spaceship can thus wreck an enemy vessel. The matrix has an accuracy of 80%.

### Steal Soul

Generation Time: 1 sec      Range: Special  
Boost: None                      Duration: Permanent  
SMR: Special                    Area of Effect: Target

Steal Soul enables the empath to absorb the soul of another into his own being. The soul is absorbed into the subconscious. The empath has access to all of the soul's memories and mental abilities. The soul can escape capture only if it is more intelligent and/or of higher level. For every point of intelligence above that of the empath, the soul has a 5% chance of escape. For every power level above that of the empath, the soul gains a 10% chance to escape. The captured soul will undoubtedly attempt to gain control of the empath's mind. There is a 03% chance per week that this will indeed occur.

## 9 POWER POINTS

### Supreme Resonance

Generation Time: 1 min      Range: 1 parsec  
 Boost: None                      Duration: Instantaneous  
 SMR: Special                    Area of Effect: Target

The most powerful of all empathic matrices. Supreme resonance turns the empath into a huge sonic receptor/gun. All vibrational energy is absorbed by the empath during the generation time. The resonance increases until it reaches uncontrollable levels. The power released is sufficient to destroy a planet. There is a 25% chance that the release of such tremendous amounts of energy will kill the empath. Oh, by the way....Destroying planets is highly illegal! (*Editors' Note: We find this to be much fun for PCs.*)

## ENERGY CONTROLLER MATRICES

### 1 POWER POINT

#### Chilled Veins

Generation Time: 1 sec      Range: Touch  
 Boost: 2 min/point          Duration: 2 min  
 SMR: None                      Area of Effect: Target

The Mutzachan lowers the body temperature of the target individual, draining the ambient heat energy. Body temperature is lowered by 10 degrees celsius. The targeted individual is racked with chills and can not function for 2 minutes per point of power expended.

#### Darkness

Generation Time: 1 sec      Range: 0  
 Boost: 1 min/point          Duration: 1 min  
 SMR: None                      Area of Effect: 20m

The power of darkness acts as an invisible mirror, refracting all incoming light entering within a 20m radius of the Mutzachan. When generated, the area around the controller is immediately cast into darkness. Normal sources of light will not function while the matrix is active. It can be counteracted by a light matrix. This power does not stop high intensity lasers. The darkness does not inhibit the sight of the MC generating the matrix.

#### Electrical Discharge

Generation Time: 2 sec      Range: 50m  
 Boost: 2 damage/point      Duration: Instantaneous  
 SMR: Electrical              Area of Effect: Target

The controller acts like a huge capacitor by storing up the static electricity in the surrounding area which he then discharges through his fingers. The target takes 1-4 points of body damage from electrical shock. Individuals who are electrically grounded take no damage from this power. For every extra point of power expended, the damage done by the discharge increases by 2 points. The charge has an 80% chance to hit at range bracket 1. This decreases 15% per range bracket. Any attack that does more damage than the threshold of a suit of armor, forces a critical check to determine whether or not the suit's systems are affected.

#### Finger Laser

Generation Time: 2 sec      Range: 100m  
 Boost: 1 damage/point      Duration: Instantaneous  
 SMR: None                      Area of Effect: Target

The energy controller generates and fires a laser beam. The beam has a 80% chance to hit at range bracket 1 and does 2 points of damage. Accuracy is reduced by 15 points beyond the 1st bracket. Each point of boost increases damage by 1 point.

#### Glue

Generation Time: 1 sec      Range: 20m  
 Boost: 1 min/point          Duration: 1 min  
 SMR: None                      Area of Effect: 10m radius

Glue instantly increases the coefficient of friction between objects, causing them to stick together. The matrix has a 30% base chance to cause objects to stick together, plus 03% chance per level of the MC above 1st .

#### Kinetic Energy Barrier

Generation Time: 1 sec      Range: Touch  
 Boost: 2 min/1 point        Duration: 2 min  
 SMR: None                      Area of Effect: Target

A kinetic energy barrier is a small, bluish-green force field that surrounds the target. The force field reduces the effects of kinetic weapons entering the barrier, draining them of inertia. The barrier reduces damage by 6 + 2 points per additional power point expended.

#### Light

Generation Time: 1 sec      Range: 0  
 Boost: 1 min/point          Duration: 1 min  
 SMR: None                      Area of Effect: 20m radius

This matrix functions exactly the opposite of the darkness matrix. When generated, the controller acts as a collection dish, attracting light particles. He radiates light at a range of up to 20m. The intensity of the light is similar to that of a lantern.

#### Metal Detection

Generation Time: 2 sec      Range: Self  
 Boost: 1 min/point          Duration: 5 min  
 SMR: None                      Area of Effect: 20m radius

Generating this matrix allows the Mutzachan to scan an area for metals. He can sense metallic bonding and can find any metal within 20m.

#### Pyrotechnics

Generation Time: 1 sec      Range: 2m  
 Boost: None                    Duration: Instantaneous  
 SMR: None                      Area of Effect: Target

This power is used to start fires on paper objects or the equivalent. The controller excites the kinetic energy in the particles of a substance so much that the temperature is raised to spontaneous combustion levels. This power affects a tiny area and can't be effectively used against enemy personnel.

#### Shatter

Generation Time: 1 sec      Range: 5m  
 Boost: None                    Duration: Instantaneous  
 SMR: None                      Area of Effect: 1 cubic meter

The controller acts as a harmonic tuning fork. By focusing upon an object such as glass, he resonates the object to the proper harmonic frequency. The molecular agitation causes the object to shatter.

#### Separation

Generation Time: 1 min      Range: Touch  
 Boost: None                    Duration: Instantaneous  
 SMR: None                      Area of Effect: 10 cubic meters

The separation matrix is used to quickly separate mixtures. (Example: The matrix can be used to extract sugar from water.)

#### Shadow Boxer

Generation Time: 1 sec      Range: 50m  
 Boost: 1m/point              Duration: Instantaneous  
 SMR: None                      Area of Effect: Target

## Special Powers

The shadow boxer matrix allows the energy controller to create a forcefield which he can cause to move quickly in any direction, doing one point of damage. This is pure kinetic energy and the threshold of a targets armor is ignored. The controller has a base 50 to hit plus 04% per level of hand to hand skill. Any intuition bonuses he might have are also added in.

### Spot Weld

Generation Time: 1 sec      Range: 5m  
Boost: None                      Duration: Instantaneous  
SMR: None                        Area of Effect: Target

The spot weld matrix allows the energy controller to fix armor integrity on a point for point basis. There must be a source of metal available. The matrix controller melts the metal into place and uses the matrix to bind it to the armor. The Mutzachan has a base 40% chance plus 5% per level over first to perform the procedure correctly.

### Temperature Manipulation

Generation Time: 1 sec      Range: 5m  
Boost: None                      Duration: Instantaneous  
SMR: None                        Area of Effect: Target

The Temperature Manipulation matrix causes an endothermic or exothermic reaction to occur. The controller may lower or raise the temperature in the surrounding area by 10-40 degrees celsius.

## 2 POWER POINTS

### Battery

Generation Time: 5 sec      Range: Self  
Boost: 10 hr/point              Duration: 30 hr  
SMR: None                        Area of Effect: Target

The energy controller can store energy inside his body. He can store up to 1000 units of power. Example: 10 charges of 100 volts equals 1000 units of power. The controller can not alter the form of the energy. That is, he can't turn electricity into plasma energy. The Mutzachan can increase the duration of the matrix by using more power points.

### Bypass

Generation Time: 3 sec      Range: Touch  
Boost: None                      Duration: Instantaneous  
SMR: None                        Area of Effect: Target

Allows the matrix user to circumvent protective measures built into a security system. The chance for success equals the level of the MC times 10. Penalty modifiers are still applied.

### Continuous Light

Generation Time: 1 min      Range: Touch  
Boost: None                      Duration: Permanent  
SMR: None                        Area of Effect: Target

The controller generates a form of a light matrix on an object. The object holds the light charge forever, or until its matrix is disrupted.

### Drain

Generation Time: 1 sec      Range: Touch  
Boost: 5 charges/point        Duration: Instantaneous  
SMR: None                        Area of Effect: Target

This matrix gives an energy controller the power to drain energy packs or other energy sources. The controller acts as a ground, draining up to 100 charge units into his body where the energy dissipates quickly. Each 50 units of power provide the Melon Head with 1 new power point. This matrix can never cause the Melon Head to have more power points than his PPC.

### Ground Sparks

Generation Time: 1 sec      Range: 20m  
Boost: None                      Duration: 10 sec  
SMR: None                        Area of Effect: Target

By agitating molecules in the ground, the controller is able to create ground sparks. These sparks are bright and do no damage, but they can distract individuals. They really mess with a Ram Python's head!

### Invisibility

Generation Time: 1 sec      Range: Touch  
Boost: 2 min/point              Duration: 10 min  
SMR: None                        Area of Effect: Target

The Mutzachan makes himself and everything on his person invisible when he generates this matrix. He can not be seen, but he is detectable by infrared and other energy detection capabilities.

### Jam

Generation Time: 1 sec      Range: 100m  
Boost: None                      Duration: Special  
SMR: Special                      Area of Effect: 1 Weapon

The energy controller can causes a weapon to malfunction. The owner of the weapon must clear the malfunction before resuming fire with the weapon. The chance for success equals 40% plus 03% per level.

### Magnetize

Generation Time: 2 sec      Range: 20m  
Boost: 1 min/point              Duration: 1 min  
SMR: None                        Area of Effect: 10m squared

This matrix magnetizes or demagnetizes the surface of objects. It covers a 10 square meter surface area. Magnetization requires a 100+ strength to break the force.

### Polymerizer

Generation Time: 2 sec      Range: Touch  
Boost: 2/1 point                Duration: 1-4 hours  
SMR: None                        Area of Effect: Target

Polymerizer is one of the most useful low level energy controller matrices. The controller pours energy into the polymer lining of armor. The effect is to repair two points of absorption per power point expended. However, there must be at least one point of absorption left in the liner. The absorption cannot be increased beyond original specifications. The polymers last for the duration of the matrix.

### Short Circuit

Generation Time: 2 sec      Range: Touch  
Boost: None                      Duration: Instantaneous  
SMR: None                        Area of Effect: Target

The controller's body act as a conductor to short out circuits. However, there is some danger involved. The controller must know how much current is flowing through the circuitry. He can absorb up to 10 amperes without being injured. Melon Heads can handle an additional 2 amps per level of experience above 4th.

### Ultra-Vision

Generation Time: 1 sec      Range: Self  
Boost: 1 min/point              Duration: 2 min  
SMR: None                        Area of Effect: Line of sight

This matrix allows the Mutzachan to see into the ultra-violet portion of the spectrum. He can detect the presence of flux shields when employing this power.

**Warp Metal**

Generation Time: 2 sec      Range: Touch  
 Boost: 1 damage/point      Duration: Permanent  
 SMR: None                      Area of Effect: Target

The Mutzachan attempts to warp the metal of an object. His chance for success equals 70% plus 05% for each level above the 4th.

**3 POWER POINTS****Activation Energy**

Generation Time: 5 sec      Range: Touch  
 Boost: None                      Duration: Instantaneous  
 SMR: None                      Area of Effect: Target

Certain devices require an activation energy in order to function. The activation matrix allows the Mutzachan to activate the device without having any previous knowledge of the code. It is also useful in causing mines which are frequency activated to detonate or to start robots.

**Displacement**

Generation Time: 1 sec      Range: 20m  
 Boost: None                      Duration: Instantaneous  
 SMR: None                      Area of Effect: Self

When this matrix is generated, the Mutzachan displaces himself up to 20m from his current location. He has a base chance of 50% to end up where he desires. This increases 05% per level of the 7th. Failure indicates that the MC has made an errant jump. To determine where he ends up, roll a d12. The result equals to the clockwise direction that he is transported. A d100 is then rolled to determine the distance. The matrix is designed to prevent the controller from ending up in a solid object.

**Fire Blast**

Generation Time: 1 sec      Range: 50m.  
 Boost: 1/2 points              Duration: Instantaneous  
 SMR: Special                      Area of Effect: 10m radius

A fire blast does 2-12 points of damage. The Mutzachan can generate the matrix up to 50m from himself. All personnel standing within a 10m blast radius are effected, yet receive an SMR vs fire based attacks. Success halves the damage. The MC can increase the damage yield by adding 2 points of power for every additional point of damage.

**Fly**

Generation Time: 5 sec      Range: Self  
 Boost: 5 min/point              Duration: 10 min  
 SMR: None                      Area of Effect: Special

This matrix provides the Mutzachan with the ability to fly. He can fly for 10 minutes, plus 5 minutes per additional point of boost. The matrix controller can transport no more than his weight plus an additional 200 kg.

**Frequency Scanner**

Generation Time: 10 sec      Range: Self  
 Boost: 500m/point              Duration: 10 min  
 SMR: None                      Area of Effect: 10km radius

The Mutzachan acts as a frequency scanner, automatically detecting any radio signals that pass within 10km of his person. He knows the frequency and the general direction of the wave propagation. He doesn't necessarily understand what he hears.

**Optical Reduction**

Generation Time: 1 sec      Range: Self  
 Boost: 1 damage/point      Duration: 5 min  
 SMR: None                      Area of Effect: Self

The Mutzachan's body diffracts laser beams. The matrix initially diffuses 5 points of high intensity light energy. Further reduction is on a point for point basis.

**Sonic Concussion**

Generation Time: 1 sec      Range: 0  
 Boost: 2/1 points              Duration: Instantaneous  
 SMR: Special                      Area of Effect: 10m radius

The matrix controller creates a sonic concussion wave that propagates outward from his body. The wave does 3-12 points of damage, plus 2 additional point per 1 point of boost. All individuals wearing body armor gain an SMR vs sonic attack forms. Success negates the attack.

**Sonic Immunity**

Generation Time: 3 sec      Range: Touch  
 Boost: 2 min/point              Duration: 5 min  
 SMR: None                      Area of Effect: Target

This matrix protects the Mutzachan from the effects of all sonic based attack forms for the duration of the power.

**Transmission Boost**

Generation Time: 2 sec      Range: Special  
 Boost: 2 min/point              Duration: 5 min  
 SMR: None                      Area of Effect: Special

This is a useful power. The matrix is designed to boost the output range of a communications device by 25%. The duration of can be extended by adding 2 points of power per additional minute.

**Transmission Jammer**

Generation Time: 1 sec      Range: Self  
 Boost: 2 min/point              Duration: 5 min  
 SMR: None                      Area of Effect: 10km radius

Another useful matrix. When this matrix is generated, the controller transmits a powerful interference pulse. All transmissions that pass through the area of effect are jammed at a 50% rating, plus 05% per level of the MC above 7th.

**Transmission Scrambler**

Generation Time: 1 min      Range: Self  
 Boost: +05% /point              Duration: 5 min  
 SMR: None                      Area of Effect: Target

The scrambler matrix allows the matrix controller to encode a message so it is scrambled across the wave bands. The controller is also capable of decoding messages. He has an encode rating of 110%. He has a 50% chance to decode. This increases at a rate of 04% per level of the MC above 7th, in addition to point boost.

**4 POWER POINTS****Cellular Disruption**

Generation Time: 1 sec      Range: 50m.  
 Boost: 5m/point                  Duration: Instantaneous  
 SMR: Biological                  Area of Effect: Target

This nasty matrix can trash the enemy in short order. The cellular disruption does 4-16 points of damage to the target. Targets receive an SMR vs biological attack forms. This matrix doesn't penetrate armor.



## Special Powers

### Cellular Immunity

Generation Time: 1 sec	Range: Touch
Boost: None	Duration: 5 min
SMR: None	Area of Effect: Self

Protects the Mutzachan from the harmful effects of cellular disruption.

### Energy Manipulation

Generation Time: 30 sec	Range: Touch
Boost: None	Duration: Instantaneous
SMR: None	Area of Effect: Target

A powerful Mutzachan is able to redefine the matrices of various energy forms. For example, he can change plasma energy into electrical energy or vice versa. He can change up to 5000 energy units.

### Explosive Lattices

Generation Time: 5 sec	Range: 50m
Boost: None	Duration: Instantaneous
SMR: None	Area of Effect: Target

Certain rocks and crystals have lattice structures, that is their molecules are arranged in a specific pattern throughout the object. The matrix controller acts as a harmonic tuning fork which causes the lattices to explode. Exploding rocks do 2-8 points of concussion damage and strike the target with 8 fragments. Each fragment does 2-8 points of damage (treat as a grenade).

### Plasma Reduction

Generation Time: 2 sec	Range: 2m wide plane
Boost: 1 min/point	Duration: 5 min
SMR: None	Area of Effect: Target

Plasma reduction disrupts that magnetic envelope that the plasma is encased in. All damage is halved. It has the same effect on Omega weapons, and all other weapons employing magnetic bottle technology.

### Plasma Pulse

Generation Time: 5 sec	Range: 50m
Boost: 2m/point	Duration: Instantaneous
SMR: None	Area of Effect: Target

The plasma pulse matrix does 4-24 points of damage at a specific target. The Mutzachan has a 75% chance to hit at range bracket 1. Accuracy drops off 15% per range bracket beyond the 1st. Accuracy, however, is increased 04% per level of the controller above 10th.

### Power Reservoir

Generation Time: 10 min	Range: Self
Boost: None	Duration: Special
SMR: None	Area of Effect: Target

This matrix confers upon the energy controller the ability to store large quantities of energy. The Mutzachan meditates and drops off into a state of semi-consciousness. He can't, under any circumstances, be distracted during the generation of this matrix. and is quite vulnerable during the process. Any distraction has a 10% chance to disrupt the Mutzachan neural signal synapses, resulting in brain damage (lose 4-24 point of IQ permanently). Once the matrix is generated, the energy controller can store up to 10,000 units of energy. He is free to convert the energy from one form to another and can store it for up to 5 days.

### Psionic Immunity

Generation Time: 10 sec	Range: Touch
Boost: 2 min/point	Duration: 20min
SMR: None	Area of Effect: Self

The Mutzachan creates an energy field that surrounds his mind and protects him from any and all mental attack forms.

### Shape

Generation Time: 5 min	Range: Touch
Boost: 30 sec/point	Duration: 5 min
SMR: None	Area of Effect: Target

The energy controller is able to manipulate the intermolecular bonding between atoms. One application is changing the shape of an object. The amount of time that it takes to change the appearance depends on the item and is determined by the BM.

### X-ray Vision

Generation Time: 2 sec	Range: 20m
Boost: 30 sec/point	Duration: 2 min
SMR: None	Area of Effect: Special

Enables the Mutzachan to see through 500cm of rock, 10cm of steel, and 2.5cm of lead.

## 5 POWER POINTS

### Combination (minor)

Generation Time: 1 min	Range: Self
Boost: None	Duration: special
SMR: None	Area of Effect: self

Combination matrix allows Melon Heads to combine the effects of any two lower energy bracket powers.

### Dimension Travel

Generation Time: 2 hours	Range: Special
Boost: None	Duration: 6 hours
SMR: None	Area of Effect: Target

The dimension travel matrix bestows upon the Mutzachan the ability to travel and operate in the fourth dimension.

### Fire Wall

Generation Time: 2 sec	Range: 100m
Boost: None	Duration: 2 min
SMR: None	Area of Effect: 25m x 10m x 2m

This matrix creates a curtain of fire, 25m long, 10m wide, and 2m thick. Anyone who crosses the curtain takes 4-24 points of fire damage, 2-8 points if they are wearing body armor.

### Flux Shield

Generation Time: 10 min	Range: Self
Boost: 10 min/point	Duration: 1hr
SMR: None	Area of Effect: 1m radius

This powerful matrix produces a 2 Heavy Point flux shield that surrounds the Mutzachan and spreads out 1m from his body. All kinetic based weapons do no damage to the shield. Lasers do half damage while pulse, particle, and Omega weapons do full damage to field integrity. The side effect of generating the matrix is that the Mutzachan becomes extremely hungry and must eat 10 units of food.

### Ice Wall

Generation Time: 10 sec	Range: 100m
Boost: None	Duration: 5 min
SMR: None	Area of Effect: 25m x 10m x 2m

Creates a 25m long, 2m thick, and 10m high solid wall of ice. The Mutzachan can generate the wall up to 100m from his person.

**Kinetic Immunity**

Generation Time: 10 min	Range: Self
Boost: 10 min/point	Duration: 1hr
SMR: None	Area of Effect: 10m radius

Produces a powerful kinetic barrier that surrounds the controller. The effects of all non HP kinetic based attacks against the field are nullified.

**Molecular Disruption**

Generation Time: 2 sec	Range: 50m
Boost: None	Duration: Instantaneous
SMR: Chemical	Area of Effect: Target

The molecular disruption matrix disrupts the bonding of all molecular structures. It affects body tissue as well as body armor. It reduces armor integrity on a point for point basis. The matrix does 6-36 points of damage. Skin and body armor both receive a SMR vs chemical attack forms. A success indicates that the damage has been halved.

**Molecular Dispersion**

Generation Time: 1 min	Range: Touch
Boost: 2 min/point	Duration: 30 min
SMR: None	Area of Effect: 5m cubed

The Mutzachan can temporarily open a hole through a solid object by dispersing the molecules in the object. The controller can disperse up to 50 cubic meters of matter.

**Omega Pulse**

Generation Time: 2 sec	Range: 20m
Boost: 2m/point	Duration: Instantaneous
SMR: None	Area of Effect: Target

This powerful matrix allows the matrix controller to create and fire an omega pulse from inside his body. The pulse has limited range. The pulse has a 95% chance to hit at range bracket 1 and is reduced 20% per range bracket. Damage is 6-36.

**Power Port**

Generation Time: 3 sec	Range: Special
Boost: None	Duration: Instantaneous
SMR: None	Area of Effect: 1 Weapon

The matrix controller acts as a boost mechanism for an object. The output power of any weapon is quadrupled. There is a chance that the matrix controller passes out after the matrix is generated. The chance to pass out equals 01% per point of damage that the weapon does. (If the weapon is a Devastator then the Melon Head usually says "Wake me when it is over"). The chance to pass out is reduced by 05% per level over 16th.

**Radiation Shield**

Generation Time: 3 sec	Range: Self
Boost: 20min/point	Duration: 1 hr
SMR: None	Area of Effect: 5m radius

The Mutzachan is taught to create an energy field that blocks out all harmful radiation. Any person within the field is protected from the effects of radiation.

**Teleport**

Generation Time: 3 sec	Range: 2000m
Boost: None	Duration: Instantaneous
SMR: None	Area of Effect: Self

Teleport allows the matrix controller to instantaneously transport himself up to 2000m from his position. The matrix has been carefully designed to avoid personnel being teleported inside objects.

**6 POWER POINTS****Anti-Gravity**

Generation Time: 1 sec	Range: Self
Boost: 1 min/point	Duration: 2 min
SMR: None	Area of Effect: 5m radius

This matrix creates an anti-gravity field around the matrix controller. Any object that happens to be contained within the field is subject to the effects of anti-gravity.

**Energy Negation**

Generation Time: 1 sec	Range: 100m
Boost: 1 min/point	Duration: 2 min
SMR: None	Area of Effect: Target

Negates the effects of any force field for the duration of the matrix.

**Kashonas**

Generation Time: 2 sec	Range: 5 parsecs
Boost: None	Duration 2 min
SMR: None	Area of Effect: N/A

This matrix is designed to rescue a stranded Mutzachan. The Mutzachan can send a subspace frequency message up to 5 parsecs. Once the matrix is completed, the energy controller must sleep undisturbed for 20 hours. (This power is a little strange. You have to send a dire message, then afterwards, you take a nap).

**Life Shield**

Generation Time: 1 sec	Range: Self
Boost: 1 min/point	Duration: 1 hr
SMR: None	Area of Effect: Target

This powerful matrix creates a field that surrounds the energy controller. No external forces can act against him, while he is inside. He can breathe normally and is able to drop the shield at any time.

**Solar Sail**

Generation Time: 10 min	Range: Special
Boost: None	Duration: Special
SMR: None	Area of Effect: Special

In a desperate situation, a Mutzachan may need to power a vessel that has lost the means to power itself. The Mutzachan acts as a solar sail, collecting the energy of the universe, then transferring the power to the ship's engines. The matrix controller retreats into the deepest of trances when this matrix is employed. The vessel can travel at 400,000km per day. For each day that the Mutzachan pushes the ship, there is a 05% chance that he will never awaken.

**Space Walk**

Generation Time: 1 min	Range: Self
Boost: 20 min/point	Duration: 1 hr
SMR: None	Area of Effect: Self

Allows the matrix controller to spacewalk. He is encapsulated in a sealed energy sphere that travels 500m per minute in any direction that the Mutzachan wishes.

**Time Slow**

Generation Time: 1 sec	Range: Self
Boost: 10 sec/point	Duration: 30 sec
SMR: None	Area of Effect: 10m radius

All persons within the area of effect are slowed and actions require twice the normal time to perform. Only the controller's actions occur at normal speed.

## 7 POWER POINTS

### Attraction/Repulsion

Generation Time: 1 sec	Range: 100,000km
Boost: 10,000km/point	Duration: Instantaneous
SMR: Special	Area of Effect: Target

The Mutzachan creates a powerful alternating attraction/repulsion beam that acts against the target. The target suffers 10-100HP points of damage.

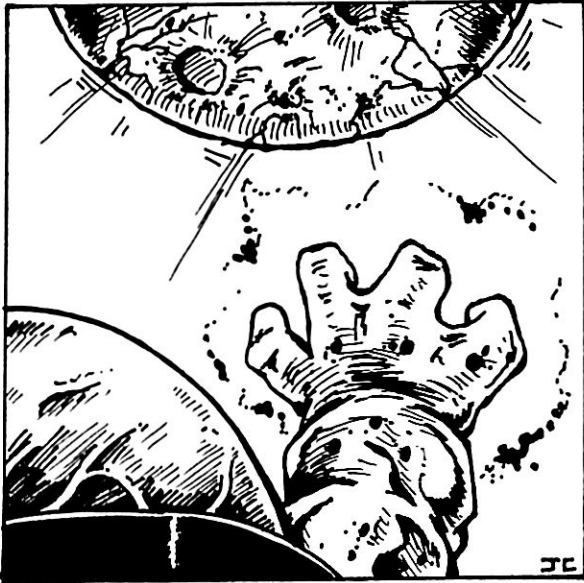

### Cancellation

Generation Time: 10 sec	Range: Special
Boost: None	Duration: Special
SMR: None	Area of Effect: Special

The cancellation matrix voids a permanency matrix.

### Energy Cloud

Generation Time: 2 sec	Range: Self
Boost: 1 HP/2 points	Duration: Special
SMR: None	Area of Effect: 1000m radius

The Mutzachan unleashes a potent energy cloud. All objects within the area of effect (not the MC) receive 4-24HP of damage. The cloud moves at 50m/sec outward from the energy controller's body.

### Mass Teleport

Generation Time: 10 min	Range: 100km
Boost: Special	Duration: Instantaneous
SMR: None	Area of Effect: Special

The energy controller is able to transport himself and a maximum of 10 persons up to 100km from his current position. For each 10 points of additional energy that he spends, the MC can transport 1 other person.

### Permanency

Generation Time: 1 hr	Range: Special
Boost: None	Duration: Permanent
SMR: None	Area of Effect: Special

The energy controller is able to make the effects of another matrix permanent. **Example:** Henry the Mutzachan could create a permanent hole by generating a worm hole matrix, then generate a permanency matrix on the worm hole matrix.

## 8 POWER POINTS

### Bind

Generation Time: 1 hr	Range: Special
Boost: None	Duration: Special
SMR: None	Area of Effect: Special

The energy controller brings together cosmic matter. The binding matrix forms planetary bodies. The matrix ages the Mutzachan by 100yrs.

### Cataclysm

Generation Time: 10min	Range: 10 km
Boost: None	Duration: Instantaneous
SMR: Biological (-10%)	Area Effect: 1 km rad

The cataclysm matrix randomly distributes large groups of molecules within the confines of the matrix. The effect is complete random and utter destruction. Personnel may wind up with metal sticking out of their bodies and have limbs transported as far as two miles away. A successful SMR vs Biological attacks saves the person. (equipment on the other hand might not be quite so fortunate...)

### Gravity Wave

Generation Time: 10min	Range: 1 Million km
Boost: None	Duration: Special
SMR: None	Area Effect: Special

The high level energy controller is capable of wrecking havoc on a large scale. The gravity wave allows the MC to create a powerful standing gravity pulse that does 1000HP of damage at the epicenter. The wave loses a HP of damage per 1000km of travel.

### Nova

Generation Time: 2 hrs	Range: 50 parsecs
Boost: None	Duration: Special
SMR: None	Area of Effect: Special

The Mutzachan can cause a sun to go super nova. Any celestial body within 1 parsec of the blast is automatically destroyed. Invoking this matrix drains the Mutzachan and ages him 200 years.

### Worm Hole

Generation Time: 10hr	Range: Special
Boost: 1 day/5 points	Duration: 30 day
SMR: None	Area of Effect: Special

This matrix opens a hole in the fabric of space. The worm hole connects two points, up to 100 parsecs from each other. The worm hole is stable for the duration of the matrix. Ships can traverse great distances in minutes by entering the matrix.

## 9 POWER POINTS

### Combination (major)

Generation Time: 1 min      Range: Self  
 Boost: None                      Duration: special  
 SMR: None                        Area of Effect: self

Combination matrix allows the Melon Head to combine the effects of any lower energy bracket powers.

### Space Fold

Generation Time: 10hr      Range: 100 parsecs  
 Boost: None                      Duration: Permanent  
 SMR: None                        Area of Effect: 100 cubic parsecs

This is the most destructive matrix known. No Mutzachan outwardly admits to knowing this power. The Council of Timar forbids its teaching. It is not clear whether any controller knows the matrix at all. It is a legendary power of frightening parameters. Anyone found to have invoked it will be punished worse than death. Space Fold allows the MC to connect two distinct points by folding space. The matrix automatically destroys anything in between! The MC ages 200 years.

### Time Travel

Generation Time: 10hr      Range: Special  
 Boost: None                      Duration: Permanent  
 SMR: None                        Area of Effect: Special

The most powerful matrix ever created. The time travel matrix allows individuals to be transported forward in time. There exists a barrier that prevents time travel into the past (or at least that is what they say).

## HEALER SPECIAL POWERS

### 1 POWER POINT

#### Awaken

Generation Time: 5 sec      Range: Touch  
 Boost: None                      Duration: Permanent  
 SMR: None                        Area of Effect: Target

This matrix will restore consciousness to any living individual, regardless of his present condition, except for those who are dead. The individual will awaken and be coherent.

#### Benign

Generation Time: 1 sec      Range: Touch  
 Boost: None                      Duration: 1-6 min  
 SMR: Mental

This matrix confers upon the individual the power to appear harmless and innocuous. The enemy must make a successful SMR or leave the controller alone, seeing him as benign and harmless.

#### Blessing

Generation Time: 1 sec      Range: Touch  
 Boost: None                      Duration: 1-8 minutes  
 SMR: None                        Area of Effect: Target

When the Zen places a Blessing on an individual, the person's morale, courage, and self esteem are increased. The recipient of a Blessing fights better in combat. He receives +20% modifiers to all combat and survival matrix rolls. The Tza-Zen can reverse this ability, causing individuals to fight at -20%.

#### Blood Stoppage

Generation Time: 5 sec      Range: Touch  
 Boost: None                      Duration: Instantaneous  
 SMR: None                        Area of Effect: Target

This basic ability is one of the first that all healers learn. The healer touches the area that is bleeding and stops the blood flow. Scientists only explain this as a psycho-kinetic function that the healer employs. The healer can restore 1-4 points of blood loss.

#### Calcify

Generation Time: 2 sec      Range: Touch  
 Boost: None                      Duration: Permanent  
 SMR: Biological                Area of Effect: Target

Calcify instantaneously calcifies the cartilage in the joints of the target. Affected individuals lose 1-4 points of agility permanently. It works really well against Phentari because they are mostly cartilage. Thus, squids take double normal damage.

#### Clarity

Generation Time: 1 sec      Range: Touch  
 Boost: None                      Duration: 1 sec  
 SMR: None                        Area of Effect: Target

The healer uses this matrix to know the immediate extent of the individual's injuries and understands which injuries are most life threatening. He can then take immediate corrective actions to aid the victim.

#### Fear

Generation Time: 1 sec      Range: 0  
 Boost: 1 min/point              Duration: 2 min  
 SMR: Mental                      Area of Effect: 50m radius

Any being that enters the area of effect is assaulted by a mental attack form, designed to cause fear. They must make a successful SMR vs Mental attack forms or flee. The SMR is reduced by 02% per each level that the healer is above 1st.

#### Mend Bones (simple)

Generation Time: 2 min      Range: Touch  
 Boost: None                      Duration: 1-4 min  
 SMR: None                        Area of Effect: Target

By touching the broken bone, a healer is able to mend it. This matrix allows the Zen to heal simple fractures. A simple fracture is any bone damage done, resulting in the loss of less than 20% of the person's body points. It takes 1-4 minutes to heal the bone.

#### Pain

Generation Time: 1 sec      Range: 50m  
 Boost: 1 min/point              Duration: 2 min  
 SMR: Biological                Area of Effect: Target

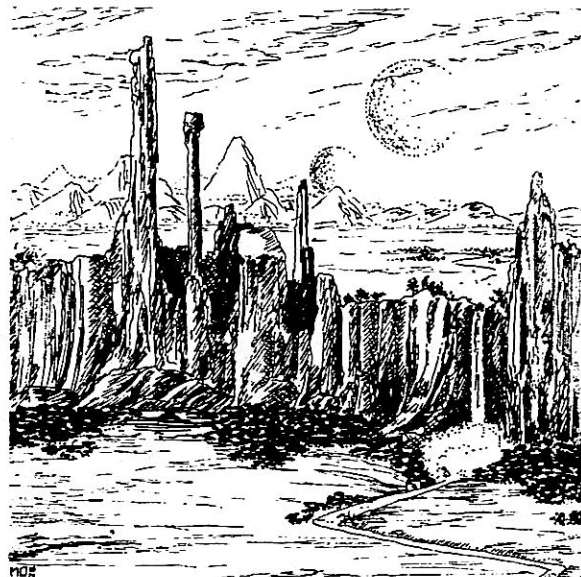

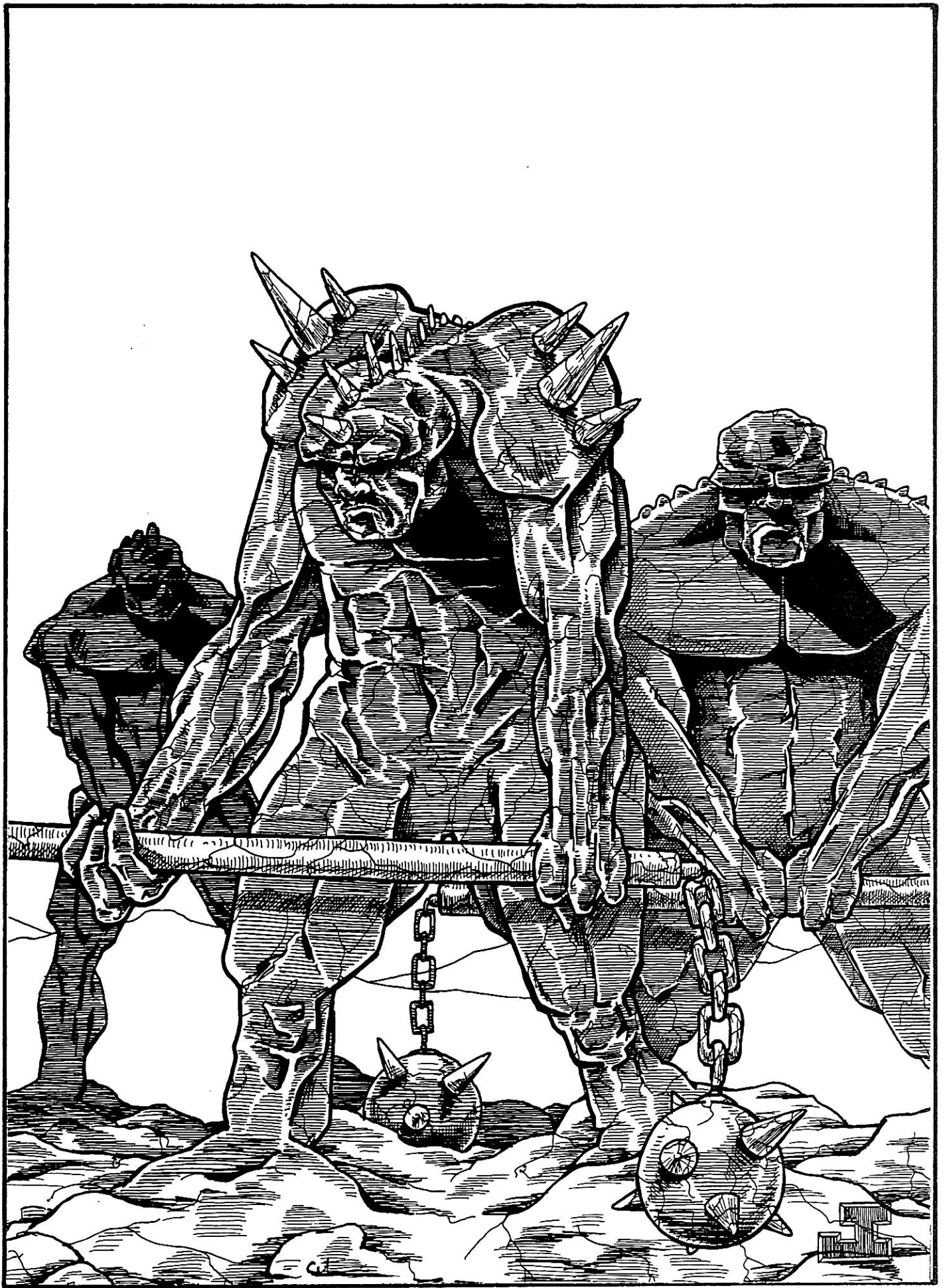

The matrix causes great discomfort to the target. His body becomes racked with pain. He fights at a -30 to all attacks and can not generate. He performs all tasks at a -50 modifier. Individuals who make a successful SMR vs biological attack forms are not affected by this matrix.

#### Plant Sentience

Generation Time: 2 sec	Range: Touch
Boost: 1 min/point	Duration: 5 min
SMR: None	Area of Effect: Target

This matrix allows the Zen to communicate with sentient plants. The Zen tunes himself to the plant and senses the leaf vibrations, understanding the meaning of their pattern. He responds by sending vibrations through his fingers to the plant.

#### Purification

Generation Time: 2 sec	Range: Touch
Boost: Special	Duration: Permanent
SMR: None	Area of Effect: Special

Characters undoubtedly run into situations where they are in dire need of food and water and the only sustenance available is considered dangerous for personal consumption. This matrix allows the Zen to purify up to 10kg of food and 20 liters of water per power point expended.

#### Ritual of Peace

Generation Time: 10 min	Range: 0
Boost: None	Duration: 6 hr
SMR: Mental	Area of Effect: 15m radius

In dangerous situations this matrix can be used to protect the recipients from attack. The Zen cuts his finger and walks in a circle, chanting quietly to himself, while dripping blood onto the ground. All intelligent creatures who fail their SMRs will not assault anyone within the area of the circle, seeing it as a sacred ground. Anyone who ventures outside the circle voids their protection.

#### Slow Poison

Generation Time: 2 sec	Range: Touch
Boost: 1min/point	Duration: Permanent
SMR: None	Area of Effect: Target

When generated, this matrix allows the Zen to trace the flow of poison within the victim's body. The healer is able to slow the rate of infection into the system. This takes time (1-4 min) and is quite draining. The poison is not neutralized; it is merely slowed.

#### Sterilization

Generation Time: 5 min	Range: Touch
Boost: None	Duration: Permanent
SMR: None	Area of Effect: Target

Often characters will sustain wounds which, due to their nature are dirty and unclean. The Zen sterilizes the affected area. All foreign bacteria are instantly destroyed. The matrix restores 1 body point of damage to one person only and covers an area of 500cm x 500cm. This matrix can also be used to sterilize equipment.

#### White Count

Generation Time: 2 sec	Range: 10m
Boost: None	Duration: 2-8 day
SMR: None	Area of Effect: Target

This matrix raises the body defenses against disease by 60%. It can be reversed to lower the body's immunity system by the equivalent amount.

## 2 POWER POINTS

#### Achilles Heel

Generation Time: 2 sec	Range: 20m
Boost: None	Duration: Special
SMR: Biological	Area of Effect: Target

The Zen can determine the most susceptible area of a individual's body to attack. The healer locates the vital area and the type of attack that will yield the greatest damage. The Zen, in effect, has found the individuals Achilles Heel. He can determine the location of the Achilles Heel even through armor. The MC has a 40% chance of successfully finding the weak point, plus 05% per level of the Zen above 4th.

#### Burns

Generation Time: 10 sec	Range: Touch
Boost: Special	Duration: Permanent
SMR: None	Area of Effect: Target

The Healer uses this matrix to facilitate the healing of burned victims. It is 100% effective against all burns except 3rd and 4th degree. A third degree burn is one in which the skin has been charred and little remains. 4th degree burns are those where the bones themselves have been burned and no skin remains. The base chance to cure a 3rd degree burn is 75% and 4th degree burns, 30%. The chance to heal increases 05% per additional point of power expended and 03% per level of the Zen above 4th. Healed wounds have little or no residual scars.

#### Cosmetic Surgery

Generation Time: 5 min	Range: Touch
Boost: 03%/point	Duration: Permanent
SMR: Biological	Area of Effect: Target

Cosmetic Surgery allows the healer to touch the recipient and change the external physical structure. The healer can remove or add scars, change appearance, etc. There is only a 25% chance to effectively do facial or other advanced cosmetic surgeries. This chance increases 05% per level of the matrix controller above 1st.

#### Cramps

Generation Time: 1 sec	Range: 50m
Boost: None	Duration: 2-8 min
SMR: Biological	Area of Effect: Target

The Tza Zen causes stomach cramps. The victims doubles up and remains prostrate for the duration of the matrix.

#### Geiger Counter

Generation Time: 1 sec	Range: 400m
Boost: None	Duration: 10 min
SMR: None	Area of Effect: Target

Has the same effects as the Mutzachan power.

#### Heal Plants

Generation Time: 30 sec	Range: Touch
Boost: None	Duration: Permanent
SMR: None	Area of Effect: Target

This matrix enables the Zen to heal wounded plants. Through intense concentration, the Zen locates the wounded area and is able to heal by touch. The power heals from 2-12 points of tissue damage. The Zen must employ the matrix plant sentience first, in order to use this power.

#### Internal Bleeding

Generation Time: 6 sec	Range: Touch
Boost: None	Duration: Permanent
SMR: None	Area of Effect: Target

## Special Powers

Once this matrix is generated, the Zen is capable of stopping the internal bleeding of wounded personal. This is caused by the body to producing mass amounts of blood clotting agents, stopping the flow of blood in seconds. The matrix can be used to stop the bleeding of organs. The matrix heals 1-6 points of internal damage.

### Methalizer

Generation Time: 1 sec	Range: Touch
Boost: None	Duration: Permanent
SMR: None	Area of Effect: Target

Methalizer changes oxygen into methane by repositioning the subatomic particles. This matrix cannot be reversed nor can it be used on any non-methane breathing race.

### Mend Bones (compound)

Generation Time: 5 sec	Range: Touch
Boost: None	Duration: Permanent
SMR: None	Area of Effect: Target

Broken bones are not always simple fractures. Some are compounds. The Zen can heal a compound fracture. Any broken bone that is suffered from a critical hit is considered a compound fracture. The healer can heal one fracture per matrix employed, requiring 2-8 minutes.

### Need

Generation Time: 5 sec	Range: 0
Boost: None	Duration: 10 sec
SMR: None	Area of Effect: 15m radius

Need is a very useful matrix which enables the Zen to scan an area covered with wounded personnel and determine who is the most injured and the extent of the injury.

### Poison Removal

Generation Time: 5 sec	Range: Touch
Boost: None	Duration: 5 sec
SMR: None	Area of Effect: Target

The Zen can extract poison from the victim's body. All toxic agents are removed when this power is employed.

### Probe

Generation Time: 2 sec	Range: Touch
Boost: None	Duration: 5 sec
SMR: None	Area of Effect: Target

Combat personnel are subject to many different types of attacks that do damage to the mind. This power probes the mind for damaged areas and determines the nature and extent of the damage.

### Reverse Peristalsis

Generation Time: 1 sec	Range: 50m
Boost: None	Duration: 2-8 min
SMR: Biological	Area of Effect: Target

Affected victims blow chunks!

### Sterilize Environment

Generation Time: 1 sec	Range: 0
Boost: None	Duration: Permanent
SMR: None	Area of Effect: 25m cubed

This matrix is a more powerful version of the basic sterilization matrix. When used, all harmful bacteria within a 25-meter radius are instantly killed. This matrix is normally employed when an operation is to be performed.

## 3 POWER POINTS

### Assizzian Palm

Generation Time: 5 sec	Range: Touch
Boost: None	Duration: Instantaneous
SMR: None	Area of Effect: Target

Grand Tour Assizza was the greatest Healer in Zen history. Assizza developed the Assizzian Palm which he used to instantly heal the wounds of a victim by pain transfer techniques, absorbing all the damage that the individual suffered into his own body. The technique has been passed down through Rigel's history. The Zen can heal up to 4 points of damage for every 1 point of body points he himself has. For every 2 points of damage he restores, the Zen temporarily loses 1 body point. This is due to the fact that the healer is absorbing the damage into his own body. All body points that the healer loses are on a temporary basis. They are restored at a rate of 5 points a day.

Generating this power can be very dangerous. There is a 02% chance that the healer will collapse during the transfer. Fallen healers slip into a deep coma, lasting 1-4 days, and have a 05% chance of irreversible death.

### Blind

Generation Time: 2 sec	Range: Touch
Boost: None	Duration: 10 min
SMR: None	Area of Effect: Target

Blind allows the Tza to cause all the blood vessels in the target's retinas to burst, blinding the target for life. The target is allowed an SMR vs. Biological attacks at a +20 bonus. However, his chances are reduced by 02% per level of the Tza above 7th.

### Cure Disease

Generation Time: 2 sec	Range: Touch
Boost: None	Duration: Permanent
SMR: None	Area of Effect: Target

This power allows the healer to cure diseased victims. The Zen has a 90% base chance to cure simple diseases, 50% for complex diseases, 20% for very complex diseases, and 10% for diseases of extremely a rare or very complex nature. The Zen may opt to increase his chances by unleashing more power. The success rate increases by 05% per extra point of power expended and 05% per level of the Zen above 7th.

### Death's Door

Generation Time: 5 sec	Range: Touch
Boost: None	Duration: 1hr
SMR: None	Area of Effect: Target

This matrix allows the Zen to lower the point at which someone dies. A typical person dies when they reach -10 body points. The Zen is able to reduce the point of death by 1-4 points.

### Essence Drain

Generation Time: 3 sec	Range: 20m
Boost: 2m/point	Duration: Permanent
SMR: Biological	Area of Effect: Target

The Tza Zen uses this to drain the life force of his victims. He drains 2-8 points of strength and constitution permanently. Potential victims receive an SMR vs biological attack forms. Success negates the attack.

### Identify Agent

Generation Time: 1 sec	Range: 0
Boost: None	Duration: 2 min
SMR: None	Area of Effect: 20m radius

This power enables the Zen to detect the presence of a biological or chemical agent. The agent is seen as a bright red spot to the eyes of the Healer.

**Mend Bones (skull)**

Generation Time: 1 min      Range: Touch  
 Boost: None                      Duration: 5 min  
 SMR: None                        Area of Effect: Target

The power necessary to control the healing process of skull bones is greater than for normal bones, due to the complex and delicate nature of the manipulation. A powerful Zen Rigeln can heal the damage done to bones by generating this power.

**Mind Healing**

Generation Time: 8 sec      Range: Touch  
 Boost: Special                 Duration: Permanent  
 SMR: None                      Area of Effect: Target

The Healer places his hands on the victim's skull and heals any damage done to the mind itself. The percentage chance of successfully healing a damaged mind depends on the nature of the wound. Simple damage 80%, moderate 50%, heavy 25%, and critical 15%. The Zen may summon more power, and raise his chance for success by 5% per point expended.

**Paralysis**

Generation Time: 2 sec      Range: 100m  
 Boost: None                      Duration: 1-4 day  
 SMR: Biological                Area of Effect: Target

The Tza attempts to paralyze his victim when generating this matrix. Potential victims receive a SMR vs Biological attack forms.

**Parasitic Infestation**

Generation Time: 2 sec      Range: 25m  
 Boost: None                      Duration: Special  
 SMR: Biological                Area of Effect: Target

The Tza infests the body of his opponent with parasitic worms. The infected individual must secure medical aid or die in 2-8 days.

**Protein Coagulant**

Generation Time: 5 sec      Range: 20m  
 Boost: None                      Duration: Permanent  
 SMR: Biological                Area of Effect: Target

Protein Coagulant causes protein molecules to break down and recombine in new and interesting ways. The target must make a SMR vs. Biological attack forms or suffer 2-12 points of damage. This matrix also breaks down absorption polymers and affects them first before body tissue.

**Remove Paralysis**

Generation Time: 10 sec      Range: Touch  
 Boost: None                      Duration: Permanent  
 SMR: None                        Area of Effect: Target

Reverses the effects of a paralysis matrix. It can also cure the effects of paralysis due to disease, poison, and biological attack forms. It cannot reverse damage to nerves.

**Speak With Dead**

Generation Time: 5 min      Range: 0  
 Boost: None                      Duration: 1 min  
 SMR: Mental                     Area of Effect: 100m radius

A powerful Zen is able to sense the presence of souls. By generating this power, the Zen calls the soul of a dead individual to him. The soul communicates via telepathic link. The Zen can ask questions and the soul will answer. However, the Zen must first locate the body of the soul to be summoned. Souls generally have tendency to stay near the area where they were killed. The chance of summoning a soul depends on the amount of time that the individual has been dead, 100% within one day, 50% within two, and 25% within three days. The souls gain the benefit of an SMR vs mental attack forms to determine if they wish to answer the summoning. This power is different from the empath equivalent.





## Special Powers

### Sonic Immunity

Generation Time: 2 sec      Range: Touch  
Boost: 2 min/point      Duration: 2 min  
SMR: None      Area of Effect: Self

The Zen summons this power to defend against forms of sonic attacks. The affects of all sonic attack are completely negated, and no damage is taken by the healer. The duration can be increased at a rate of 2 minutes, per additional power point expended.

### Strangulation

Generation Time: 10 sec      Range: 50m  
Boost: 2m/point      Duration: Special  
SMR: Mental      Area of Effect: Target

This matrix confers upon the Tza Zen the ability to strangle an enemy at a distance of up to 50m. Any person who fails his SMR vs mental attack forms dies in 1-6 min.

## 4 POWER POINTS

### Age

Generation Time: 2 sec      Range: Touch  
Boost: None      Duration: Permanent  
SMR: None      Area of Effect: Target

The Zen causes the bodily aging process to speed up or reverse when this power is used. The individual will age 10-40 years in seconds.

### Animate Dead

Generation Time: 3 sec      Range: 0  
Boost: 5 min/point      Duration: 10 min  
SMR: None      Area of Effect: 20m radius

The Zen generates this power to manipulate dead bodies. He can animate or make them perform any mechanical task. The healer can control the body for up to 10 minutes. He can control the zombie for an additional 5 minutes per extra point of power that the poured into the matrix. The body is slow and clumsy, controlled much like a puppet. The zombie is totally unintelligent and will collapse if left uncontrolled.

### Cellular Disruption

Generation Time: 1 sec      Range: 50m  
Boost: 5m/point      Duration: Instantaneous  
SMR: Biological      Area of Effect: Target

Produces the same effects as its Mutzachan equivalent. This power is used only by the Tza Zen.

### Cellular Immunity

Generation Time: 1 sec      Range: Touch  
Boost: 2 pts/min      Duration: 5 min  
SMR: None      Area of Effect: Target

Has the same effects as the Mutzachan equivalent.

### Deform

Generation Time: 2 min      Range: 100m  
Boost: Special      Duration: Permanent  
SMR: Biological      Area of Effect: Target

Deformity causes nasty transformations which reduce all vital statistics by a total of 100 points, not including IQ or Intuition. For each additional point of power, the Tza Zen can further deform the body. The Tza dictates what type of deformities and this determines which vital statistics are affected.

The additional power points added are poured into the matrix over a period of time. Each power point takes 10 seconds to input and

further deforms the body by 5 vital statistic points.

### Divine Assistance

Generation Time: 10 min      Range: Special  
Boost: None      Duration: 2 min  
SMR: None      Area of Effect: Special

Zen Mythology speaks of great spirits who protect the Good and Righteous. The spirits are called the Grue. Scientists have proven the existence of these entities, having documented their manifestation. The Grue manifests itself as a huge, two headed lion-like beast, with red eyes and a deep, silver coat. When in dire need, the Zen can call on the spirit for assistance. Often, it will answer the call. The chance of a Grue answering a summons is 25% per try. Only five such tries can be made, without incurring the wrath of the mighty Grue. The Grue has 200 body points and attacks with a 80% chance to hit. 3 times per hand to hand melee segment for 2-8/2-8/3-18.

### Embalm

Generation Time: 30 min      Range: Touch  
Boost: None      Duration: Permanent  
SMR: None      Area of Effect: Target

At times, it is necessary to preserve the remains of an individual. The Zen uses this power to place the victim's body in stasis. The body will not deteriorate or decompose. It takes a long time to complete this procedure and afterward the Zen must rest for 1-4 hours. The person can not be revived.

### Ectoplasm

Generation Time: 10 sec      Range: 5m  
Boost: None      Duration: Permanent  
SMR: Biological      Area of Effect: Target

Ectoplasm is a lovely matrix that yields wonderful results. The target must make a successful SMR vs Bio or be reduced to a quivering gelatinous mass. (i.e. DEAD!) They gain a +20 to their SMR. Ectoplasm is quite useless against Mazians.

### Heal

Generation Time: 1 min      Range: Touch  
Boost: 1/point      Duration: Permanent  
SMR: None      Area of Effect: Target

This powerful matrix heals 2-12 points of body damage. Each additional point added, heals another point of damage.

### Heavy Sleep

Generation Time: 1 min      Range: Touch  
Boost: None      Duration: 60 hr  
SMR: None      Area of Effect: Target

The Zen can place a willing individual in a sleep by utilizing this power. While in deep sleep, the person regains body points at three times the norm. An individual in heavy sleep can only be awakened by the Zen who performed the matrix. After 60hrs, the effects wear off and the person automatically awakens.

### Insta-Medic

Generation Time: 2 min      Range: Touch  
Boost: None      Duration: 30 hr  
SMR: None      Area of Effect: Target

When the Zen utilizes this energy matrix, he is able to lend some of his power to another for a short period of time. The Zen transfers his knowledge to the individual by implanting the pertinent information in the other's subconscious mind. The individual has 4 power points worth of energy. The recipient is able to generate any of the 1st bracket powers that have been lent to him. The Zen can only transfer knowledge that he already knows. The matrix lasts for 30 hours.

**Leprosy**

Generation Time: 2 sec	Range: 0
Boost: None	Duration: Permanent
SMR: None	Area of Effect: 100m radius

The Tza Zen inflicts anyone within the area of effect with leprosy. The effects are permanent and the victims lose 10-60 points of charisma, 10-40 points of constitution, and 20-80 points of manual dexterity. Leprosy occurs over 2-8 days. The disease is dry leprosy and cannot be passed on to another person. Cure Disease cancels any further deterioration of bodily functions, but can not heal any damage already incurred.

**Mind Shield**

Generation Time: 2 sec	Range: Touch
Boost: 1 min/point	Duration: 5 min
SMR: None	Area of Effect: Self

When this power is generated, the Zen closes himself off to any forms of mental and sonic attacks. The healer submerges his consciousness and is completely aware of the events around him and can perform any normal task. He can not, however, use any other matrix while the mind shield is up. He can boost the shield by adding extra power.

**Muscular Dystrophy**

Generation Time: 5 sec	Range: 100m
Boost: None	Duration: Permanent
SMR: Biological	Area of Effect: Target

This matrix causes the victim's muscles to atrophy. He loses 10-40 points of strength and agility in 10-40 days. This power is only used by the Tza Zen.

**Radiation (lethal)**

Generation Time: 2 min	Range: Touch
Boost: None	Duration: Permanent
SMR: None	Area of Effect: Target

The Zen can cure individuals who have been exposed to lethal doses of radiation.

**Ward of Assizza**

Generation Time: 10 sec	Range: 0
Boost: 10 min/point	Duration: 1 hr
SMR: None	Area of Effect: 20m radius

The great Assizza understood the principles of creating divine peace. He passed this knowledge to his descendants. When a Zen Rigeln utilizes the energy matrix necessary to create a Ward of Assizza, he brings into being a place of temporary sanctuary. He sits down and chants the invocation of power. A tranquil peace abides as long as he has the energy to keep up the field. No intelligent individual or creature will attempt to harm anyone within the field of the circle. They will feel a serene peace and tranquility emanating from within. The field lasts only as long as the Zen chants.

**5 POWER POINTS****Alter Visage**

Generation Time: 7 sec	Range: Touch
Boost: None	Duration: Permanent
SMR: None	Area of Effect: Target

This power allows the Zen to permanently alter the physical appearance of an individual. The change is only superficial and doesn't involve size or genetic structure. Interrupting the matrix during the alteration can produce ghastly results.

**Calling of Tashim**

Generation Time: 2 sec	Range: 0
Boost: 20m/point	Duration: 1 min
SMR: Special	Area of Effect: 400m radius

In times of great need, the Zen can send a powerful telepathic message, designed to bring assistance. All friendly, intelligent, non evil creatures within 100m will answer the summons. Each creature receives a SMR vs mental attack forms to determine if they heard the message.

**Cancer**

Generation Time: 10 sec	Range: Touch
Boost: None	Duration: Permanent
SMR: Biological	Area of Effect: Target

This matrix causes a malignant cancer to form within the victim's body. The afflicted individual will expire within 1-12 months.

**Cure Amnesia**

Generation Time: 1 min	Range: Touch
Boost: Special	Duration: Permanent
SMR: None	Area of Effect: Target

A powerful healer is often trained in the skill of repairing the mind. Many are taught this matrix to cure amnesia. The Zen places his hands on the victim's head and speaks the invocation of power. The memory of the victim is restored. This matrix can be used by the Tza to cause amnesia, but the victims are entitled to an SMR vs mental attack forms.

**Disembowel**

Generation Time: 1 sec	Range: Touch
Boost: None	Duration: Permanent
SMR: Biological	Area of Effect: Target

An evil Tza Zen invokes this matrix by placing his hands on the target and speaking the proper words. He sucks the victim's internal organ's from the body into his hands. Targets are allowed an SMR vs Biological attack forms.

**Essence Transfer**

Generation Time: 1 sec	Range: Touch
Boost: None	Duration: Permanent
SMR: Biological	Area of Effect: Target

The Tza sucks the life force out of his victim. The anti-healer gains 2-20 points of strength and constitution, along with 1-3 body points, while the target loses the same. However, if the target makes his SMR the Tza must make a SMR vs Bio or bite the big one. The effects are permanent.

## Special Powers

### Exorcism

Generation Time: 3 sec      Range: 10m  
Boost: None                      Duration: Instantaneous  
SMR: Special                      Area of Effect: 1000m cubic

Once a Zen reaches the Order of the Red Robe, he can exorcise entities and souls. A successful exorcism indicates that any entity within the area of effect has fled and will not come near the Zen for 30 hours, if it returns at all. All entities with an intelligence lower than that of the Zen do not receive a survival matrix roll. Those entities with intelligences higher than the Zen gain a survival matrix roll equal to the difference between the two intelligence scores.

### Heartless

Generation Time: 6 sec      Range: 50m  
Boost: None                      Duration: Permanent  
SMR: Biological                  Area of Effect: Target

The Tza Zen can tear the heart out of a person from up to 50m. The heart is sucked out of the chest and toward the hand of the Tza at 5m per second. Targets receive an SMR vs Biological attack forms. There is a 02% chance that the Zen will screw the whole thing up and suck out his own heart as well!! Wouldn't that look cool!!!

### Mother's Milk

Generation Time: 1 sec      Range: Special  
Boost: None                      Duration: Permanent  
SMR: None                        Area of Effect: Target

The Zen quest for the gem Casestone, a rare and beautiful rock found only on the planet Katre (although it is sold in some fancy/shmancy jewelry stores for 5000 credits per 1/2 carat stone). Casestone has phenomenal properties associated with it. One such property is that with the proper matrix code, the stone can be placed in water and the water and stone metamorphose to form Asgillia Fatinan, "Life's Blood". The strange, blue liquid restores up to 50 body points when consumed. The body is replenished, all diseases are cured, and the individual feels vibrant and alive. The stone can only be used once.

### Touch Subconscious

Generation Time: 15 sec      Range: Touch  
Boost: 10 sec/point              Duration: 1 min  
SMR: None                        Area of Effect: Target

When using this power, the Zen reaches into the subconscious of any individual. The Zen can remove or implant knowledge or search the subconscious for information. Searches for information have a 50% success rate per minute.

### Zashmil

Generation Time: 1 sec      Range: body  
Boost: 20 sec/point              Duration: 2 min  
SMR: None                        Area of Effect: Target

Zashmil was a legendary Zen Rigeln warrior during the Second Age of Prosperity. Lore has it that Zashmil ventured far and wide, seeking adventure and combat, something forbidden to the Zen race. He never lost a duel, having learned to tap into his inner life force and temporarily raise his body points. When a Zen utilizes this energy matrix, his body points are raised by 4-16 points. The duration of the matrix can be extended by adding 3 power points per additional minute.

## 6 POWER POINTS

### Cryogenic Freeze

Generation Time: 10 sec      Range: Touch  
Boost: 2 day/point              Duration: 1week  
SMR: None                        Area of Effect: Target

The high level Zen Rigeln is capable of staving off the death of the wounded or fatally diseased by placing an individual in suspended animation. The Zen touches the individual and uses his power to slow the vital processes to a minimal level. The person doesn't age and his condition remains suspended for up to one week. The duration of the condition may be extended by expending more power.

### Enshrinement

Generation Time: 6 hr      Range: Special  
Boost: None                      Duration: Permanent  
SMR: None                        Area of Effect: 10m cubed

The Zen can create a peaceful ambience at high levels of power to enshrine a building, hollow, or cave. The Zen begins to meditate and affixes the matrix codes to the walls of the abode. No individual of evil intention is able to cross into the enshrinement and any attempt to do so, results in the individual suffering 4-24 points of body damage from an energy discharge. The Zen can't be blamed for directly injuring the individual.

### Entombment

Generation Time: 2 sec      Range: Special  
Boost: None                      Duration: Permanent  
SMR: Special                      Area of Effect: Target

The Zen sometimes detains malicious beings by creating a representation of the matrix codes on the walls of the area and luring the individual into it. He then completes the code through a verbal message and entombs the victim. The victim receives no survival matrix roll and is stuck in the tomb for eternity or until released by another Zen.

### Famine

Generation Time: 1 hr      Range: 0  
Boost: None                      Duration: Permanent  
SMR: None                        Area of Effect: 20km radius

The anti-healer brings famine and pestilence to everything that exists within the area of effect. All vegetation automatically withers, from the effects of this matrix.

### Mass Healing

Generation Time: 4 sec      Range: 0  
Boost: None                      Duration: Instantaneous  
SMR: None                        Area of Effect: 50m radius

When this ability is generated, the Healer can, with the slow sweeping motion of his hand, heal any individual within 10m of his person. He restores up 500 body points in 4 seconds as the situation warrants.

### Palthison

Generation Time: 1 hr      Range: Touch  
Boost: None                      Duration: Permanent  
SMR: None                        Area of Effect: Target

Palthison is the power to raise one's body points permanently. Its use is very dangerous because the Zen actually attempts to change the genetic makeup of the person. The process takes one hour. If at any time, the Zen's concentration is broken, the individual automatically dies. The process is 95% successful and a roll of 96 or higher indicates that the matrix change has failed and the individual has croaked. Furthermore, any attempt at resurrection will be futile since the chromosomes have been randomly transposed onto different DNA molecules. Palthison ages the Zen by 5 years. The matrix permanently raises the recipient's body points by 2-8 points.

### Raise Dead

Generation Time: 5 sec      Range: Touch  
Boost: None                      Duration: Permanent  
SMR: Special                      Area of Effect: Target

A Zen has the ability to reattach a soul to its proper body if he can do so in a short period of time. He has 1 minute from the time of death to reach the victim and summon the soul back to the body. Restored individuals are 1 body point above death's door and must be attended to immediately or they will expire again. The energy used to restore an individual is very taxing, draining 20 years off the Zen's life. After restoring someone, the healer must sleep undisturbed for a minimum of 12 hours.

#### Regenerate Limb

Generation Time: 5 min	Range: Touch
Boost: None	Duration: Permanent
SMR: None	Area of Effect: Target

Highly trained Zen are taught how to facilitate the regeneration of body limbs. The Healer must be immersed in the deepest state of concentration to perform this feat, meditating intensely for 1 hour while the body replicates the cells necessary to restore the limb. Using this power drains 5 years off a Zen's life. After the regeneration is complete, the Zen must rest for a period of no less than 30 hours.

### 7 POWER POINTS

#### Alter Form

Generation Time: 10 sec	Range: Touch
Boost: None	Duration: Permanent
SMR: None	Area of Effect: Target

When utilizing this power, the Zen can completely alter the form of an individual by changing the genetic structure. Again, an interruption while the Zen is transforming the body can be disastrous.

#### Death's Crossing

Generation Time: 10 min	Range: Special
Boost: 1 min/2 points	Duration: 10 min
SMR: None	Area of Effect: Special

This powerful ability is taught to only the most promising of the Red Robes. The Zen can die temporarily, leaving his body, and move in the 4th dimension. The Zen will be able to communicate with entities there. The Zen's soul must return to his body within 10 minutes if he is to revive himself. He can extend the time of his out of body condition by adding more power. Damage done to the Zen's soul while he is out of body is real.

#### Disciple

Generation Time: 10 sec	Range: Touch
Boost: None	Duration: Permanent
SMR: None	Area of Effect: Target

When an aging Zen dies, he often wishes to pass along part or all of his knowledge to some deserving student. The knowledge passed is stored in the subconscious and slowly surfaces as the individual comes of power.

#### Implant

Generation Time: 2 hr	Range: Touch
Boost: None	Duration: Permanent
SMR: None	Area of Effect: Target

The trained Zen can interface electronics with body tissue, and therefore implant devices into the body. Implantation takes about 2 hours.

#### Soul Savior

Generation Time: 1 hour	Range: Special
Boost: None	Duration: Permanent
SMR: None	Area of Effect: Target

The Zen are allied with many friendly entities. Powerful Zen can link a soul or entity to physical life by melding it with a dead body. The body must be fresh, no more than 2 days dead. The soul or entity must learn to manipulate the body and this takes time.

#### Temple of Healing

Generation Time: 4 hr	Range: Special
Boost: None	Duration: 1 day
SMR: None	Area of Effect: 400m cubed

The most powerful Zen can heal wounded persons on a large scale. The Healer must find an unoccupied cave. He begins his chant which continues for 30 hours. He may heal up to 5000 body points worth of damage. At the powers culmination, the Zen is cast into a coma-like sleep for 4-16 days.

### 8 POWER POINTS

#### Clone

Generation Time: 2 hrs	Range: Special
Boost: None	Duration: Permanent
SMR: None	Area of Effect: Special

One of the most powerful Zen matrices. The trained Zen can clone an individual in a very short time. The Zen need only have a DNA sample of the individual to be cloned. Using this power ages the Healer by 20 years.

#### Plague

Generation Time: 5 min	Range: 0
Boost: None	Duration: Permanent
SMR: Biological -10%	Area of Effect: 100km square

The Tza Zen can infect a huge area with the deadly Virean Plague. All persons die within 100 days from the aerial infusion. Only a Zen of level 24 or higher can cure the disease.

#### The Power of the Tza

Generation Time: 1 sec	Range: 0
Boost: None	Duration: Instantaneous
SMR: Biological	Area of Effect: 50 meter radius

The Tza merely invokes this matrix and everything within 50 meters dies instantly.

#### Reincarnate

Generation Time: 10hr	Range: Special
Boost: None	Duration: Permanent
SMR: None	Area of Effect: One individual

The Zen can bring back an individual's soul in a new body. The Zen must have control of the soul and the reincarnation takes 10 hours.

### 9 POWER POINTS

#### Ra

Generation Time: 4 day	Range: Special
Boost: None	Duration: Permanent
SMR: None	Area of Effect: Special

This most wonderful and horrific of the Zen powers. The Zen is capable of creating life on a planetary basis. The Zen performs Genesis, the creation of life. The matrix alters the planet's makeup to create the new life. This matrix ages the Zen by 50 years.

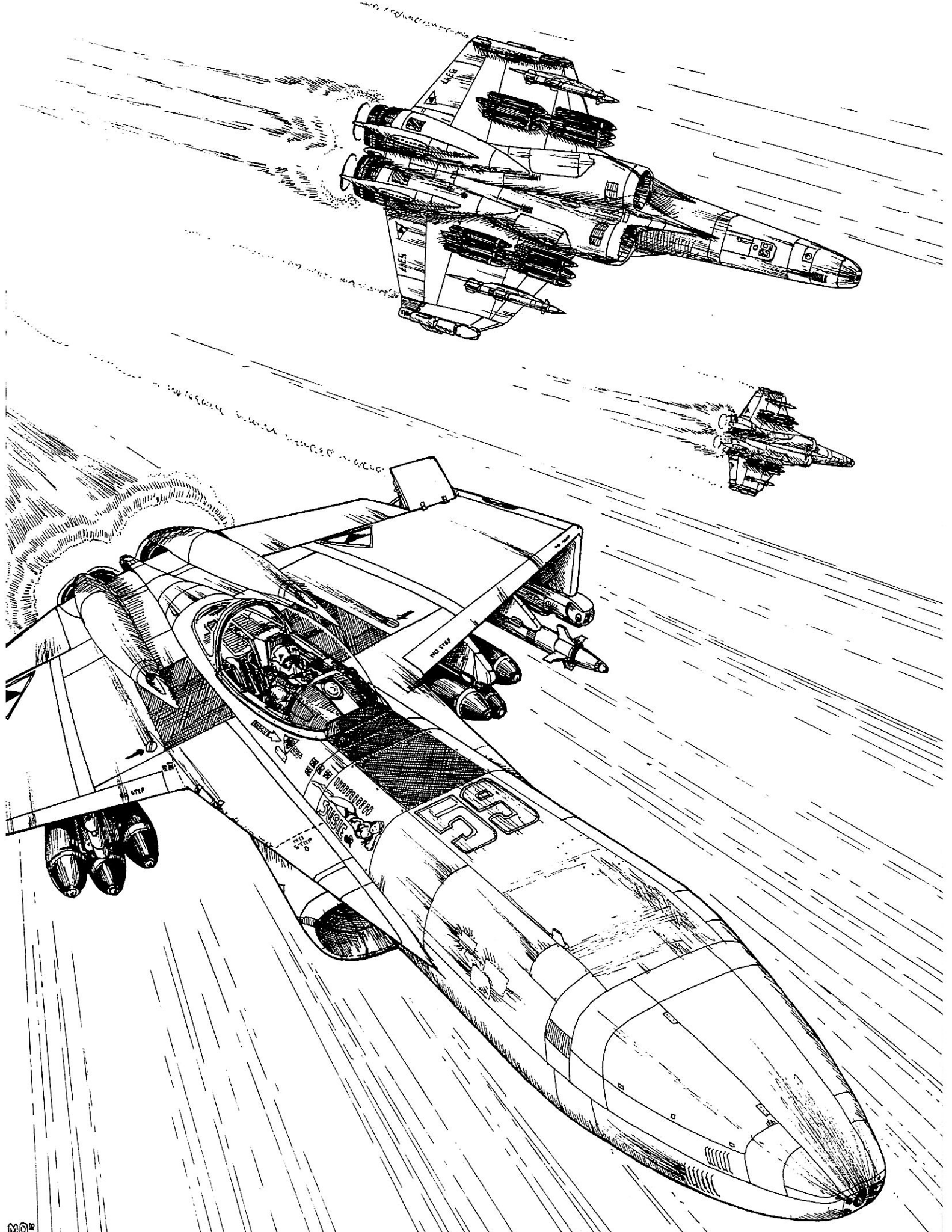

## THE BATTLE MASTER

It's a brutal job, but someone has to do it. This section deals with being the Battle Master. He alone controls the entire universe. Being a Battle Master (BM) isn't easy. Unlike the players, you are responsible for a vast body of knowledge and must stay on the "ball" all the time. You play all the non-player aspects of the game. You are the killer attack robot. You are the tiny paramecium. You are, in fact, everything that isn't a player character. Now the good thing about being the Battle Master is that you get to set up everything that happens. You get to place the traps that the party stumbles into. The party has to kill the monsters that you just happen to want to play.

I personally prefer being in charge and I was a game master for the better part of 8 years. Sometimes I created excellent scenarios, other times I bored my players out their minds. It's all part of the job. Whatever the case, the Battle Master is the single most important aspect of the game. If he is good, then the game will be good. It all depends on how he runs the show. A terrible system can be great, if the right person is behind the scenes. A good system can be made even better, if the BM sets up the right scenario. I am not going to give you an entire discourse on how to run the game. You don't need it. I'll provide all the basics and highlight the fine points of running a good system.

## TYPES OF BATTLE MASTERS

There are several types of Battle Masters. Each has his own style of handling things. Every BM does things his own way. The crucial point is that there is no absolute right way to run any system. There are some definite wrong ways though. The net result must be that the players enjoy playing and come back again. Players must be challenged. That's it, nothing more. Below are listed some of the typical types of game masters, good and bad.

**The Funneller:** This guy only sets up a few different possible scenarios. He takes away all the party's options and makes them follow a specified path. The players have little choice in the determination of their own fate. It is already predestined for them. They are merely funneled into acting it out. The Funneller must be stopped at all costs. This guy gets the worst rating as a BM. He is terrible and should be relieved of his duties immediately.

**Monty Haul:** This dude is almost as bad as the Funneller. Maybe they are cousins. Who knows? Now don't get me wrong, Monty Haul means well. He is a nice guy. That's the big problem. He is too nice! You kill 2 Arterian swamp rats and he rewards you with 5 M-80 pulse rifles, 7 M-16L lasers, 200,000cr, and 20,000 experience points. Monty Haul gives you just too much stuff! After about two months of play you own four powerful mega-corporations and your own battle fleet. When you spot a Monty Haul, put a stop to him.

**The Ad-Libber:** He can be either a great BM, or a terrible one. It's that simple. An Ad-libber merely outlines the particular scenario to be played. Most of the information, he keeps in his head. He generally sets up the parameters to be followed and reacts to events as they occur. To be a good ad-libber, you must be able to react continuously to a stream of events as they unfold. You must be able to function within the basic guidelines that you've set up. The key to running this type of game is to be able to keep track of events and decisions after they occur. If you fail to do this, your players will be screaming at you, "I wasn't there when that happened. I wasn't even born when Freddy dropped that grenade in the middle of the party!" You have to be careful, that's all.

**Strict Battle Master:** My favorite! He is just like me, but being strict isn't always a good thing. Strict Battle Masters generally have the scenarios extensively planned. You tend to keep heaping mounds of maps and other useful information. The problem is that you generally aren't able to react well when players characters do things that are totally "off the wall." You become obstinate when the players don't do

what you planned for them to do. That is because you just spent 4 hours setting up the whole "deal" and they didn't do one thing that they were supposed to. On the other hand, being strict also gives you better overall control of events. Players can argue, but as long as things are written then there will be few problems.

**Axe Murderers:** The toughest and meanest of all Battle Masters is the Axe Murderer. His game has the highest attrition rate imaginable, somewhere between 98 and 99 percent casualties. He gets a thrill out of killing player characters. He sets up the toughest scenarios and the most lethal traps. He justifies the blind execution by saying that the clues were there for the party to find. If there is one bright spot in his running, it is that things will never be dull. But the problem is that players never become attached to their characters. They figure that they are going to lose them anyway and become quickly disenchanted and bored with the campaign.

What's the right answer then? Create intense, yet fun situations where your players are challenged and enjoy playing the game. Try to keep them alive. But don't make it so that they can't get killed either. The answer is balance. A little bit of everything. There should be a chance to get "offed," but it should not be a 90% chance. Balance is the key to running a good campaign.

## HANDLING PLAYER CHARACTERS

First of all, there are 3 basic types of gamers.

The first type is the Hack and Slasher. These guys love combat. As a matter of fact, that is all they want to do. Nothing makes them happier than trashing monsters. They get bored if there aren't enough things to kill. Hack and Slashers also prefer weapons and armor for their treasure. To make sure that Hack and Slashers are happy, you have to create intense combat situations.

The next type of player is the non-combat type. These guys are more cerebral in their approach to gaming. They tend to favor thought-orientated approaches to roleplaying as opposed to direct combat. Cerebral players enjoy the roleplaying aspect of gaming. They are generally interested in problem solving and subtleness appeals to them the most. To make a cerebral player happy, you have to give him mental problems to solve. You have to finesse him. This isn't easy and takes a while to get good at, but once you get used to it, there shouldn't be too many problems.

The final type of player is the power monger. My old housemate was one of these guys. Power mongers seek to obtain the best weapons, the most expensive armor, and the highest salary. Power mongers will stretch your game to its limits. They always seek to become invincible. They are notorious for using NPCs (Non Player Characters) as cannon fodder. You must control the monger. Every once in a while you will probably have to knock him down a notch or two.

## RUNNING YOUR OWN CAMPAIGN

A good topic to explore. If you aren't into running modules, then you probably will enjoy setting up and running your own campaign. Some Battle Masters enjoy running modules. Others can't stand it. But whatever, running your own campaign takes a little skill. There are certain fundamental approaches that must be employed if one is going to set up a good adventure.

First, you have to be organized. As the Battle Master, you have to get things straight in your own head before you unleash them on everyone else. Normally, I try to come up with a skeleton outline before I do anything else. I first determine what type of adventure I want to run and the basic goal to be obtained. I establish all the planned encounters and add in the optional encounters. Make sure to add hints that they can employ to solve their quest. Finally throw in a smattering of treasure that will line the path to their undaunted success.

There are 3 basic types of campaigns that a BM can run, one nighters, modules, and campaigns. One nighters can be a lot of fun.

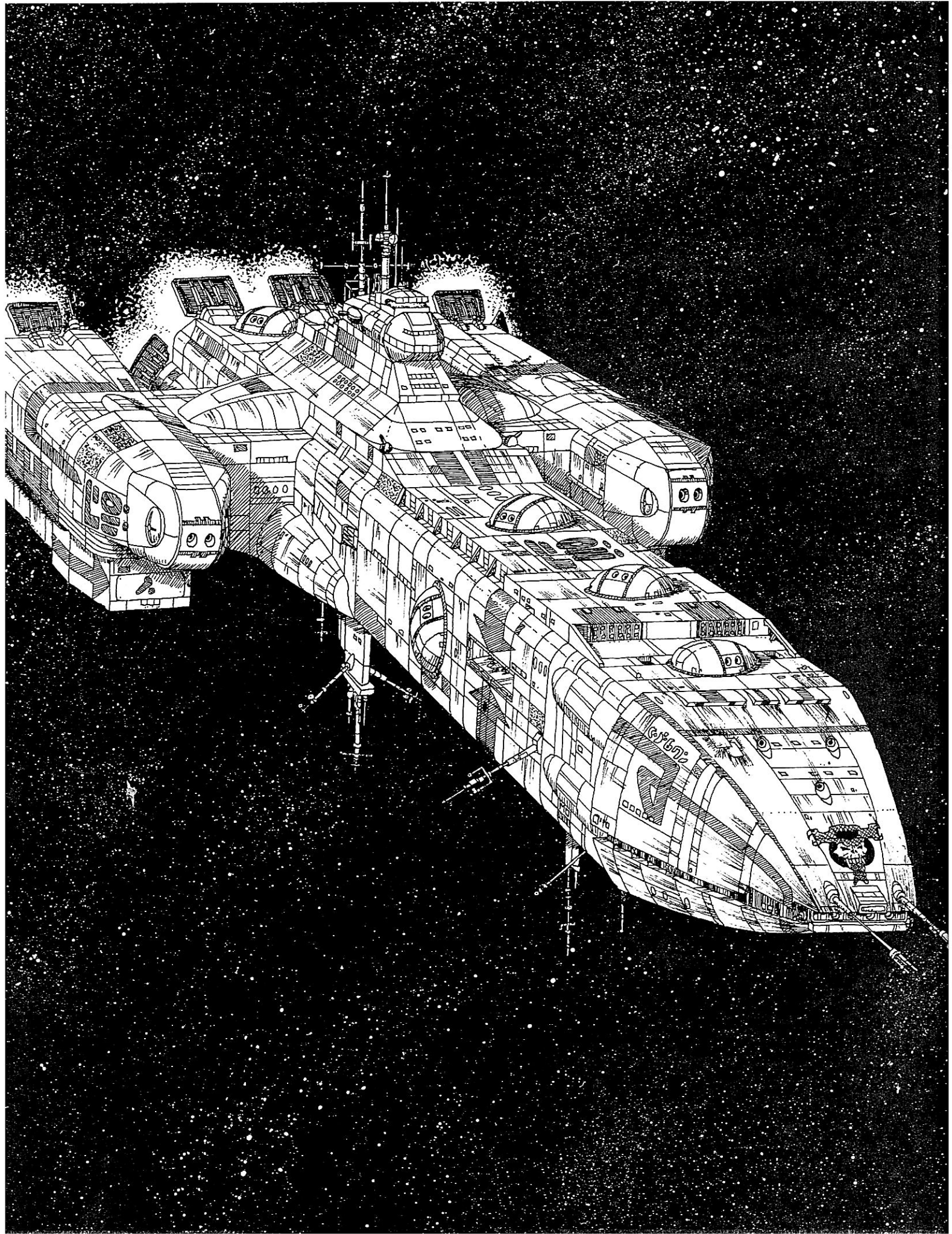

You basically want to start and finish the module in one game session. My typical one nighter has 4 encounters: 1 thought, 2 combat, and 1 problem solving. I hide 2 small caches of treasure or 1 big one. Modules are different. These take lots of planning. You should employ NPCs, if you are going to run this type of game. Most modules take 3-6 sessions to complete. For a good module, you should set up 6-12 encounters of various types, create several problems, and set out a couple caches of treasure or other valuable commodities. Campaigns are just ongoing modules that run together. They can go on for years. There is no set limit to the length of a campaign.

Maps! Maps! My kingdom for more maps!! They are great to design! A good map can make your game much more appealing. Players like to travel in labyrinthine passages. It's great when your down in some god forsaken place without a clue where to go next. Another thing about maps is that they help the BM to control the game. The creme de la creme is that when you make a good map you get to place all those nasty traps!

There are three types of maps: general maps, local maps, and building priority maps. General maps give the basic layout of a large area such as a country or continent. They display mountainous regions, coastal areas, etc. Localized maps are generally somewhere between 50 and 100 square kilometers in size. Localized maps show the disposition of towns, buildings, fields, forests, etc. These are good if you are designing a module. The last type of map is the building priority map. These maps are intricate in their design, showing the exact position of rooms, staircases, traps, and the like. This map is the most often used in any roleplaying system. To design a good building priority map, I suggest that you first draw the general layout, and then focus on putting in the secret doors, passageways, monsters, and traps afterward. Make sure to take into consideration building design when laying out the blueprints. Also: **DON'T PUT MONSTERS AND TRAPS IN EVERY ROOM. PLEASE!!! THIS MAKES THE GAME BORING, IT ALSO MAKES NO SENSE.**

## EXPERIENCE POINTS

Battlelords of the 23rd Century is designed with a natural progression of power. Most games give out more and more experience points as you advance in levels of power. The same is true of this game. Be careful not to give out too many experience points. If player characters become too powerful too soon, things get out of hand. I generally give more experience points for coming up with innovative strategies and roleplaying than I do for killing things. Why? Because it takes more thinking. This is my view. Again, just use discretion when handing out XPs.

Most players prefer to receive experience points at the end of every session. This allows them to monitor their character's progression. I suggest that you do this. Some BMs prefer to give them out at the end of every adventure. My players always wanted them at the end of the night though. Experience points should be given out for the following reasons, excellent roleplaying, task performance, for killing monsters, and for well thought out strategies.

**Task Performance:** Each skill task is assigned a difficulty rating. If the character performs the task he is rewarded as such: Multiply the Difficulty rating by 10. The result obtained is how many experience points that the character earns.

**Roleplaying:** Whenever the player acts in character, above and "beyond the call of duty", award him extra experience points. Assign a roleplaying rating from 1-25, just as you would assign a task difficulty rating. If he plays out a scenario that is difficult to do, assign a roleplaying rating of 10, for super difficult roleplaying, maybe assign a rating of 15-18, and so on. Figure out the roleplaying rating at the end of every game session. Multiply the rating by 100 and that is how much experience the player should receive.

**Killing Monsters:** This area is very subjective. You must figure out how difficult it is to slay the enemy, based on the technology employed by the party. If it is relatively easy to wax the monster, assign a kill

rating of 1-3, difficult: 10-13, suicidal: 18-25, etc. Multiply the rating by 50 and the result obtained is the amount of experience that the party receives as a group.

**Efficiency:** Every time the group plays well together, award them bonus experience points. Assign them an Efficiency rating, based on how well they performed together. Poor group play would rate a 1 whereas an exceptional group would earn a 15+ rating. Multiply the rating by 50 and award this much experience to each character.

**Good ideas:** When a player's intelligent actions help the group, award 50-500 experience.

## EXPERIENCE VS PROFICIENCY POINTS

Adventuring characters accrue experience points. Players receive these points as stated above. For every 1000 experience points accumulated, the character receives a skill proficiency point. Proficiency points enhance the character's ability to perform tasks related to his or her occupation. A player may opt to use up some or all of his proficiency points to train in a skill. However, the player must have the money required to attend the school and the time necessary to complete the training. Upon completion of training, a character gains the related percentage increases, designated by the particular skill.

**Matrix Controllers gain proficiency slots at half normal rate of other classes.** They gain an additional proficiency point for every 2000 accrued points of experience. This is due to the fact that as they gain experience points, they also receive power points. One half of all accumulated experience points count toward the character's advancement as a matrix controller, the other half are put into obtaining new proficiency points.

## VITAL STATISTICS CHECKS

These are very important. Many gamers have approached me on the issue of vital statistic checks. Apparently, many roleplaying games have stats that the character never uses. This is total garbage! Every stat should be important. It is the stats that help to make up the character's "body," if you will. I have taken great pains to create a system where all the vital statistics are used. In many systems, the most important stats are strength and agility. That is completely ridiculous! The most important stats in Battlelords of the 23rd Century are I.Q. and Intuition. Now this is not to say that strength doesn't play an important part in a character's survival. Just not as much as most games claim. Here is how to handle the different vital statistic checks.

**Strength:** Strength checks are made every time a character tries to lift or move a large object, attempt to batter a down door, bend metal, etc. A strength check is not necessary to pick up a normal backpack, but if you wanted to try to flip Fredd the Python head over heels, you would need to make a strength check at a large penalty.

**Manual Dexterity:** A very important stat. All tasks utilizing intricate work with one's hands require a manual dexterity check. Tying one's shoes is considered to be a level 1 difficulty while close quarters circuit board soldering might be a level 12 check.

**I.Q.:** Intelligence applies to the majority of skill tasks. I.Q. is the most important vital statistic in Battlelords of the 23rd Century. Check the occupational skills table for more information. If a particular player's character is supposed to be dumb as a rock, then don't let him play as if he were Albert Einstein. Simply penalize the player who chooses to ignore the fact that his character is a total moron.

**Agility:** This stat measures how fleet of foot one is. A player character should make an Agility check whenever he performs a task requiring balance, such as dodging or performing an acrobatic maneuver. Agility is applied most often to hand weapon and hand-to-hand combat.



**Constitution:** The constitution statistic gives us an idea of how hardy a character is. It represents his relative toughness and durability. Constitution checks are made for disease, system shock, etc. **WHENEVER a character is critically wounded, a system shock roll is made to determine if the individual has lost consciousness. SEE CRITICAL TABLE.**

**Aggression:** It tells us just how mean Fredd really is. Whenever a character gets himself in sticky combat situations, this stat is utilized. It tells you how likely that person is to run away or go berserk. But just because one is aggressive, doesn't mean that he is stupid enough to charge blindly into combat. It just tells you that he is thinking hard about it (if *thinking* is the right word to use). Ram Pythons don't count!!! Normally, if a character is down to 2 body points or less, he is on the verge of passing out. He is afraid and panicky. A character with a low aggression rating, tends to throw down his weapon and flee when he reaches 2 or 1 body points.

**Intuition:** A must! Make PCs roll an Intuition check every time that they don't know what to do next. Take the party's highest intuition score and make the check secretly. Don't let characters see the roll. Apply situational modifiers as you see fit. If the party fails an intuition check by only a few percentage points, then tell them that they aren't sure of what the best move is. If they fail by 20 points or so, give them false information. But if player characters fail miserably, tell them that they don't have a clue what to do next. Don't just give the players the answers. This roll is just to see if they can find clues that are available. What they do with the clues is up to them.

**Charisma:** This is different from what people think it is. It just gives an indication of how the Galactic masses will generally react to the individual. Within his own species, a PC gains a modifier to Charisma checks. Use this check a lot, especially when player characters come into direct contact with UNFAMILIAR faces. Whenever characters are in crowded places such as bars, stores, etc., charisma becomes an important stat.

**NOTE!!! WHENEVER CHARACTERS PERFORM A TASK THAT IS NOT COVERED AS A SKILL, HAVE THEM MAKE A CHECK BASED ON THE PRIMARY VITAL STATISTIC THAT IS APPROPRIATE FOR THE TASK. ASSIGN THE CHECK A DIFFICULTY RATING FROM 1-25 LIKE ANY OTHER TASK.**

## SECONDARY SKILLS CHECKS

Secondary stats are derivatives of the primary stats. They are used to perform specific tasks.

**Terrestrial Knowledge:** Checks are made whenever a PC may or may not know a particular important piece of information about the galaxy.

**Military Leadership:** It represents the ability to lead troops. It is important in that it tells us how hirelings and NPCs are going to react when they are given orders by the PC. Troops often "break and run." This stat check is most often used to determine the morale of friendly troops.

**Persuasion:** Powerful!! Checks are made EVERY TIME that a player character tries to gain information from NPCs. How the NPC reacts depends on the persuasiveness of the character.

**Bargaining:** This isn't the same as persuasiveness, although they are similar. Bargaining is one's persuasiveness under a specific situation, namely that of trying to persuade someone to sell something at a good price. **WHENEVER a character attempts to purchase goods on the Black Market or sell used weapons, he or she must make a Bargaining Check.**

## OCCUPATIONAL SKILLS CHECKS

This topic covers all skill related tasks. Whenever player characters have to perform a task, they must roll to determine if they are successful. The Battle Master must determine the difficulty level of the given task to be performed. How do you do this? Simple enough. A level 1 task is one that can be done with even the smallest amount of training. There is no limit to the difficulty level of a task. **Example:** A level 1 task in operate computers would be performing something like gaining access to the computer's files. A level 10 task might be using the computer to access secret programs. A level 25 task is doing the impossible, like using a ship's bio-computer to run the weapons console. As the Battle Master, you alone determine the difficulty rating and apply the modifier to the dice rolls. The difficulty rating breaks down into six relative groupings.

**Level 1: Easy.** Requires little effort to perform the task and deals only with the fundamentals.

**Level 5: Intermediate.** Requires some knowledge of more advanced applications of the skill. Execution entails planning and forethought.

**Level 10: Complex.** Requires extensive knowledge of the subject matter to perform the task. There are multiple steps, requiring much thinking and pre-planning.

**Level 15: Very Difficult.** Extensive modifications to the basics must be applied to perform a 15 level difficulty task. The individual must make precise calculations in order to execute the fundamentals. Even with proper planning, there is a fair degree of error involved.

**Level 20: Extremely Difficult.** An extremely difficult task is one that can only be carried out by the masters in their respective field of endeavor. A level 20 task is one that entails dealing with concepts that have seldom, if ever, been employed. Performing a level 20 task entails delving into the area of research and theory.

**Level 25: Impossible.** Those individuals who perform level 25 degree difficulty tasks are effectively doing the "impossible". They are breaking fresh ground with an unorthodox approach that has never been successfully recorded or tested. Doing the impossible requires parametric thought, copious notes, calculations, and lots of luck.

## COMBAT

I'm going to make this section short. You have to be able to handle this part of the game or everything is "Over." Combat in Battl Lords of the 23rd Century takes place in seconds. As the Battle Master you must retain control of the situation as it unfolds. Don't let the PCs start telling you what they are doing all at once, because someone is going to claim that they didn't do what YOU thought they did! The player character gets himself killed, but it is because you made a mistake. If you keep things in order, most problems will be alleviated.

Discharge combat is combat that results from the discharge of weapons. Discharge combat usually occurs before any other type of combat. Initiative for discharge combat is expressed in tenths of a second.

There are three one second segments, equaling one discharge round. A hand to hand combat segment is also 3 seconds long. During this segment, all blocks, parries, and feints are carried out. Player characters roll for initiative then secretly decide what they are going to do, whether they intend to parry, dodge, attack, etc. If both sides block or parry at the same time, then no decisive action has taken place. **ONLY** when one or both sides attack is combat carried out.

Special Powers combat takes place in accordance with the time that it takes to generate. There are three types, Powers vs Powers, Powers vs Hand, and Powers vs Discharge. Under Powers to Powers combat, initiative is determined by rolling a d10 and then adding to it the number of seconds that it takes to generate the power.

**Example:** Henry the Mutzachan is generating a power that takes 2 seconds to generate. A 4 is rolled when initiative is determined. (2 + 0.4 = 2.4). It takes 2.4 seconds to generate the matrix. The individual with the lowest overall initiative number always strikes first.

Powers vs Hand to Hand combat is determined as follows. The matrix controller designates which matrix he intends to generate. Initiative is rolled. The overall time to generate is determined by adding the generation time to the initiative die roll. Then Hand to Hand combat initiative is rolled normally. The lower number strikes first. Should the Hand to Hand combatant strike first and roll a hit against the matrix controller, then the matrix is voided along with the power points that were used to generate it.

**Example:** Fredd the Python and Henry the Mutzachan are involved in the final show down. No guts. No glory! Henry attempts to generate a Fire Blast matrix. This power takes 2 seconds to manipulate. Fredd rolls a 1 on a d10. Fredd has initiative. Fredd strikes with his two handed sword. He scores a hit. Henry takes damage to his armor. Henry can't generate the Fire Blast because his concentration has just been broken. Fredd reaches out and cuts Henry's throat.

**Powers vs Discharge:** Simple! Discharge goes first.

*A warrior smiles, eyes bulging  
He sees nothing,  
For he is dead.  
Body broken,  
Body broken,  
He smiles,  
The smile of clear vision.  
Clear and empty eyes stare outward,  
As if asking the question  
Why?  
Swollen tongue hangs out,  
Still holding the scream of,  
  
Body Broken.  
  
Rebel*

## CRITICAL HITS

Whenever a character takes more than 25% of his body points as damage, then he has been wounded severely and the Battle Master should consult the Critical Hits table. The Critical Hits Table is also used to determine where hits strike armor, even though the hit doesn't do damage. Modern body armor provides formidable protection, and most of the time a character wearing battle armor is safe from injury. Occasionally, the armor's absorption polymers break down completely, leaving the wearer vulnerable. He, aware of his precarious predicament, scrambles for cover. Too late..... Someone already has his number!

The following tables are designed to accurately portray the lethal aspect of combat in the 23rd Century. Battle Masters may use them or not as they see fit. NOTE!!! Lasers and pulse cannons cauterize the wound when they hit and there is no further blood loss. Disruptors and Disintegrators double the amount of blood loss that occurs. This is due to the massive hemorrhaging that Neutron Effect Weapons cause when they hit. In the case of laser damage to the bone. It is assumed that the beam burns through the bone and the overall effects are the same. Often combat personnel suffer stomach or intestinal damage as a result of being hit. In the event of internal poisoning, characters lose 1 body point per minute from poisoning. If you receive any critical effect which says to make a system shock roll, you must make a system shock roll every minute until you fall unconscious, or are treated by trained medical personnel.

Cumulative damage is accrued to an area and causes a critical. Personnel who have taken a critical hit automatically lose 1 point of blood per minute, and they must roll a System Shock or fall unconscious.

**Note!!!** Ignore any critical hit rolled against an Eridani that is considered fatal. The Eridani is entitled to roll a System Shock at a -20 penalty to see whether or not he actually dies. If and only if he fails the roll is he dead. Head removed criticals do however kill a Swordsaint.

01	Left foot shattered (-35 agility)
02-03	Left calf, clean (-15 agility)
04-05	Left shin bone shattered (-45 agility)
06	Left knee shattered (-60 agility, -10 permanent)
07	Left calf, artery (-25 agility, Bleeds 2 BP/min)
08-10	Left thigh, clean (-25 agility)
11-13	Left thigh bone shattered (-60 agility)
14-15	Left thigh, artery struck (-25 agility, Bleeds 2 BP/min)
16-17	Left hip bone chipped (-30 agility)
18	Left hip bone shattered (-60 agility)
19	Right foot shattered (-35 agility)
20-21	Right calf, clean (-15 agility)
22-23	Right shin bone shattered (-45 agility)
24	Right knee shattered (-60 agility, -10 permanent)
25	Right calf, artery (-25 agility, -2 BP/min)
26-28	Right thigh, clean (-25 agility)
29-31	Right thigh bone shattered (-60 agility)
32-33	Right thigh, artery struck (-25 agility, -2 BP/min)
34-35	Right hip bone chipped (-30 agility)
36	Right hip bone shattered (-60 agility)
37	Groin, clean (-70 agility, -20 system shock, -3 BP/min)
38	Groin, removed (-100 agility, -60 system shock, -4 BP/min)
39-44	Lower abdomen, clean (-35 agility, -10 system shock)
45-46	Stomach ruptured (-35 agility, -25 system shock, SMR vs poisoning or die in 2-8 minutes, -3 BP/min)
47	Stomach ruptured (-35 agility, -25 system shock, SMR vs poisoning or die in 1-4 minutes)
48-49	Liver (-4 BP/min)
50-51	Liver. You are spilling blood everywhere and making quite a puddle (-6 BP/min)
52	Intestines (-35 agility, SMR vs poisoning, -4 BP/min)
53	Multiple organs (-80 agility, -80 system shock, die in 1-4 min)
54	Lower spine. Forget walking or doing the "Wild Thing". (-120 Agility, -50 system shock, 50% paralysis)
55-59	Lung punctured (-50 agility, -65 system shock, 4 BP/min) Asphyxiation from drowning in blood in 1-4 minutes
60-61	Struck spinal cord, (-120 agility, -50 system shock, 50% chance of paralysis)
62	Spinal cord is now in two distinct sections (instant death)
63	Heart (unconscious, -10 BP/min)
64	Blows heart apart (instant death)
65	Multiple organs struck. Internals reduced to a jelly-like mixture. (instant death)
66-68	Ribs (-40 agility). You got lucky!
69-71	Ribs shattered (-50 agility, -30 system shock). Move and the chips have a 50% chance of puncturing a lung or two.
72	Collar bone broken (-30 agility)
73	Left hand shattered (-10 agility, -60 manual dexterity, -10 permanently)
74-76	Left arm (-10 agility, -40 manual dexterity)
77-78	Left arm, messy (-30 agility, -45 manual dexterity, -2 BP/min)
79	Left elbow shatters (-20 agility, -60 man dex, -20 permanently)
80	Left shoulder, clean (-30 agility, -40 manual dexterity)
81	Left shoulder broken (-40 agility, -60 manual dexterity)
82	Right hand shattered (-10 agility, -60 man dex, -10 perm)
83-85	Right arm (-10 agility, -40 manual dexterity)
86-87	Right arm, messy (-30 agility, -45 manual dexterity, -2 BP/min)
88	Right elbow shattered (-20 agility, -60 man dex, -20 permanently)
89	Right shoulder, clean (-30 agility, -40 manual dexterity)
90	Right shoulder broken (-40 agility, -60 manual dexterity)
91	Larynx (-25 agility, -30 system shock, can't speak for 2 weeks)
92	Neck (-25 agility, -60 system shock, -3 BP/min)

- 93 Mouth (-1 BP per min, -10 charisma permanent)
- 94 Face partially removed, (unconscious, -3 BP/min, -20 charisma permanently)
- 95 Jaw shattered (-20 agility, -40 system shock, -3 BP/min)
- 96 Enters eyes and exits back of skull. (instant death)
- 97 Forehead (unconscious, -5 BP/min, -10 points of I.Q. and intuition permanently).
- 98 Temple (concussion, -80 system shock, disoriented 2 days)
- 99 Top of head blown off (You're history pal!). There is all kinds of neat stuff oozing everywhere.
- 100 Head removed from the shoulders and you don't walk around like a chicken with its head cut off. (roll up new character)

## WOUND RECOVERY TABLE

The wound recovery table is designed to depict the effects of wounds on combat personnel. The recovery period is expressed in days and the associated problems are listed. The associated problems are given as a guideline to the BM. The rest period lists the number of body points received per number of days rested. For example: Fredd stabs Henry in the throat. If Henry receives prompt medical attention, he will not suffocate. However, he will only get back 1 body point per 8 full days of rest. Henry is out of action for awhile, unless he has some BRI's. This table is optional and you can use it as you see fit.

TYPE	ASSOCIATED PROBLEMS	MEDICAL TREATMENT	REST PERIOD
Surface	none	suture	1/2
Puncture(clean)	infection	suture	1/4
Fracture(simple)	none	cast	1/6
Fracture(compound)	none	cast	1/10
2nd Degree Burns	none	ointment	1/2
3rd Degree Burns	infection	hospital	1/10
Genitals	blood loss	hospital	1/10
Spleen	blood loss	surgery	1/10
Kidneys	internal poisoning	surgery	1/15
Intestines(large)	internal poisoning	surgery	1/10
Intestines(small)	internal poisoning	surgery	1/12
Lungs	drowning in blood	surgery	1/20
Heart	extreme blood loss	surgery	1/30
Stomach	peritonitis	surgery	1/15
Liver	blood loss, infection	surgery	1/15
Throat	suffocation	tracheotomy	1/8
Skull	brain damage	surgery	1/30

## HEALING

Undoubtedly, characters suffer body damage during combat. It is inevitable. They need emergency medical treatment. Afterward, they may spend long periods of time convalescing before returning to combat. Sometimes they just "croak". Wounds heal according to the severity and type of wound. Healing can be expedited by obtaining immediate medical care. Critically wounded individuals shouldn't be moved. Moving a critically injured person often results in the demise of many a good warrior. Characters should take immediate measures to help speed up the recovery process, such as splinting fractures and stopping the loss of blood. NOTE! Blood transfusions restore 2 body point each (blood loss only). Body Rehabilitation Injections speed up the recovery process at an incredible rate! Characters should purchase BRI's in large quantities. The Zen Rigeln possess special powers that can also be used to heal wounded individuals. Adventuring PCs are strongly advised to bring a Healer along for the ride.

## TRAPS

While adventuring, player characters will undoubtedly run into traps set to cause injury or worse. Players may opt to take proficiency in Detect Concealment or Set Traps in order to spot traps before it is

too late. Players who have proficiency in Set Traps may devise their own traps, as well as spot those laid by others.

There are three basic types of traps. The first is designed to injure or maim an individual. It usually uses blades, spikes, or the like to puncture and dismember.

The second type of trap is one which, when triggered, incapacitates or captures the victim, but does not cause harm. Nets, pits, snares, or gasses are employed to render the victim helpless.

Finally, there are those traps that are designed to kill. These are the most common type of traps. There are a wide variety of methods to slay characters who haven't taken adequate precautions. Most use some kind of toxic or explosive device, though primitive cultures use pits, spikes, etc. to kill their victims.

## LEARNING NEW POWERS

Matrix controllers have to travel across the galaxies to learn new powers. Unless they are near their home planet, they have to seek out a Mentor to teach them new matrices. This isn't always easy. To control the advancement of matrix controllers, simply make it difficult for them to find a teacher. Or maybe just charge them an arm or a leg. Matrix controllers become very powerful at high levels. By limiting the powers that they can be taught, you can keep the game balanced. The base chance to find a teacher is 70%. For every level of the controller, this is increased by 05%. The chance is decreased however, by 20% per level of the energy bracket above 1st. Example: The base chance to find a teacher for a 3rd energy bracket power, is 70-40=30%. A 4th level MC would gain a +20 to his chance to find a teacher. He would have a 50% chance.

Players are also going to try to stretch powers to their limits, seeking to pervert the intended meaning. Sometimes this is a good thing. Other times, it is bad. If the player has come up with a genuinely innovative way to use the power, then let him. But if he comes up with something bizarre and ridiculous, let him try it. But if the matrix is manipulated incorrectly, well... Players who come up with good methods, should be awarded extra experience points. Players who employ bad methods should receive a special surprise...

## NON PLAYER CHARACTERS

Non-player characters, or NPCs, are an essential part of any roleplaying system. To the Ad-Libber, they are his bread and butter. NPCs are those characters who interact with the party. They have their own personalities. As the Battle Master, it is your responsibility to roleplay the NPCs. YOU HAVE TO BE THE NPCs!! Give them their own distinct personalities. That is all that needs to be said about it. You live or die by your NPCs!!!

The type of NPCs that the party encounters depends on the situation. The table below lists the types of NPCs generally encountered. To determine the response of a NPC to a PC, take the character's charisma score and subtract the reaction modifiers as applicable. The Reaction Modifier (RM) denotes how the NPC type generally responds to information probes. The chance for the NPC to possess any vital information is denoted by (SK).

INDIVIDUAL TYPES	RM	SK
01-30 Sedentary Male	-05	10
31-50 Sedentary Female	+05	05
51-55 Military (enlisted)	-50	50
56-60 Military (officer)	-70	90
61-70 Club Employee	-20	25
71-75 Combat Type	-30	15
76-80 Police	-80	95
81-85 Bounty Hunter	-60	95
86-90 Slave	+10	05
91-100 Merchant	-15	10

**SITUATIONAL MODIFIERS**

Minor Information Probe	-10
Major Information Probe	-25
Specific Information Probe	-60
Slightly Intoxicated	+15
Drunk	+30
Bribe (per 200cr)	+10
Drugged	+40
Captured	+90
Tortured	+125
Afraid	+50
Poor Roleplaying	-20
Fair Roleplaying	00
Good Roleplaying	+10
Excellent Roleplaying	+25

All modifiers are cumulative and are immediately applied to the persuasion checks.

**LEVEL OF INFORMATION**

01-30	No Information
31-50	False Information
51-75	Minor Information (Wilderness)
76-95	Minor Information (City)
96-100	Major Information

**RANDOM ENCOUNTERS**

There are a variety of people that adventuring parties can run into at the spaceport or local city. Of course, what type of person you run into also depends on the planet you are on. Below is given a table for a typical planet, where all sorts of Alliance subjects would be present.

01	<b>Agitator:</b> SEE MONSTERS	31	<b>Government Official:</b> Most encounters will be with a minor official (70%), 30% with a high official. Major officials always have 2-8 guards in their company.
02-05	<b>Arms Dealer:</b> He will be escorted by 2-8 guards wearing anything from Bear to Mesh armor and toting a variety of weapons. 40% are Eridani, 30% Phentari, and 30% other.	32-40	<b>Laborer:</b> 1-12 encountered going to and from work. There is a 15% chance that they will be drunk or mischievous. 30% of all laborers encountered will be miners, salvage personnel, etc. who have rough personalities; 2-8 levels of Hand to Hand combat skill.
06-08	<b>Assassin:</b> Encounters are locale dependent. Assassins are almost never encountered inside a government controlled area spaceport, etc. (10%). They typically carry laser pistols or archaic powder weapons with silencers.	41-42	<b>Matrix Controller:</b> 1-4 encountered. 95% chance to be wearing proper attire. 50% base chance to offer services if paid. The controller will be from 3-8 level in mastery.
09-14	<b>Beggar:</b> Bums are just as common today as they were 200 years ago on Earth. 1-2 will be encountered. There is a 1-10% chance that the beggar will possess some useful information about the city. Forget getting anything out of a beggar unless you are prepared to part with some cash. There is a 20% chance that a beggar will have pick pocket skill, 1-4 levels.	43	<b>Mentor:</b> 2-8 students will be in his favor when encountered. He will possess powers from 3-6 powers per energy bracket. The Mentor will be of 9th or greater level in mastery.
15-17	<b>Black Marketeer:</b> Poses as a businessman or commoner. 1 typically encountered. 1-4000cr on person. Extensive knowledge of outfitting stores. Purchase weapons for 10-20% on the spot; 50% likely to be of other help.	44-50	<b>Mercenary:</b> Completely depends on the circumstances. 1-4 encountered 70% of the time, 2-12 27% of the time, and 03% of the time 10-40 will be encountered. Mercenaries will have 3-8 levels of skill. If 8 or more are encountered, there will be a leader with 10-20 levels of skill in his preferred weapon.
18-20	<b>Concubine:</b> Cash and carry!	51-57	<b>Merchant:</b> 80% likely to have 1-4 guards. 2000-12,000cr on hand 85% of the time.
21-25	<b>Drunk:</b> 1-6 bombed, wrecked, hosed, or hammered persons will be encountered of various types and mixture.	58	<b>Moig Dua:</b> 2-12 will be encountered. Tech Level 4 weaponry.
26-30	<b>Guard:</b> 1-8 encountered, double inside spaceport. 90% chance carrying a comm device. Each will have 5-9 levels of skill in his preferred weapon. If 5 or more are encountered, there will be a leader with 10-15 levels of skill in his favorite weapon.	59-60	<b>Noble:</b> Dignitaries will be in the presence of 4-16 suitors, 2-8 guards, and 2-8 assistants. 20,000 to 120,000cr on person.
		61-67	<b>Policeman:</b> One encountered, 25% of the time, 2 cops 70% and 3-12 cops 05% of the time. 5-8 levels of weapon skill.
		68-70	<b>Pirate:</b> Unless you have connections you will never know who he is. 95% of the time armed with sophisticated weaponry.
		71-72	<b>Rebel:</b> 30% of the time there will be guards out of sight nearby. 90% of all rebels carry a cyanide tablet. Rebels are 85% likely to have extensive knowledge of the area. 50% will have Tech Level 4 or lower weaponry.
		73	<b>Sage:</b> 95% likely to have extensive information about the area. 70% likely to assist friendly party members. 1-4 assistants will carry large quantities of papers, documents, and other valuable information.
		74	<b>Shadow:</b> SEE MONSTERS
		75-85	<b>Slave:</b> Most slaves are unescorted, wearing Collars Of Force 65%. 35% of the time there will be 1-4 guards, 20% with a master. Slaves are 95% likely to be loyal to anyone who helps them escape.
		86	<b>Spy:</b> He has 60-80 points worth of espionage skill. 25% chance a spy has a minor in weapons or demolition.
		87-92	<b>Traveler:</b> 1-6 will be present, 50% likely to be families. Each will carry 200-2000cr of cash on person.
		93-96	<b>Thief:</b> 1 present 60% of the time. 40% 2-8 encountered with 4-8 levels of skill. If more than 4 are encountered there will be a leader. He will have a Tech level 3 or

higher weapon and 8-16 levels of skill. Thieves are 80% likely to have useful information.

97-100 **Tradesman:** Possess 5-10 levels of skill in their field of endeavor. 65% likely to contract themselves out for a fee. 50% cash up front.

## TIME

Every Game Master has run into the problem of how to keep track of sleep, time, food, and use of non salvageable equipment. It is incredibly tedious and time consuming. It slows down the flow of the game. So how do you do it? Guesstimate. That is the normal solution to the problem. The Game Master merely takes a stab in the dark at the amount of used up stuff. In campaigns, this is almost always the case. Players always try to pull one over on the BM. He generally ends up agreeing with the self righteous player who is stamping around, foaming at the mouth, about an arbitrary ruling on the BMs part. He has kept track. He has only eaten two meals in 18 days, and drunk one glass of water. It doesn't work like that. So I've come up with an incredibly easy way to handle the problem. It takes very little time to keep track of supplies and at the same time keep the flow of the game moving. A supply sheet functions rather nicely. Here is how to use one.

A solar day isn't 24 hours long everywhere in the Galaxy. It just so happens to be the case with Earth. That's all. Chronologists of the future measure time in 30 hour increments. Each day is an arbitrary 30 hours long. A standard month is 35 days long and a year 350 days. (Why then is the Galactic Time table expressed in normal earth standards?) So it is easily understood from a human frame of reference.

Each box in the time section of the supply sheet, represents a six hour block of time. There are thus 5 blocks in a day. As the Battle Master, you make periodic time checks to determine random encounters, etc. This is done every 3 hours. A line is then drawn diagonally across the face of the box. The lines alternate direction. After six hours, two lines have been drawn in different directions. The result is an X in the center of the box. After 10 checks have been made, a standard day has passed.

## FOOD

Individuals must eat to stay alive. Food is expressed in units as an arbitrary frame of reference. Pythons and Cizerack required 6 units of food a day, Phentari 5, all other Humanoid types 3. Eridani and Mazian need only consume 1 unit per day. Failure to eat the required amount, may result in quick fatigue, malnutrition and death. Assume that characters must stop to eat every 10 hours. Each box in the food section represents 3 units of food. In most cases, each time a day passes, a box is checked off the initial amount of food boxes. Pythons can go 10 days without food, yet suffer no adverse effects. Cizerack, on the other hand, must eat every day. Any Cizerack who doesn't eat, must double all penalties that are applied to vital statistics.

Characters may ration food. This means eating less than one's normal eating allowance. Humanoid types must then eat a minimum of 2 units per day, Pythons and Cizerack 5, Phentari 4, and Eridani/Mazian 1. Characters who ration food subtract 10% from all vital statistics as long as they are rationing, except I.Q. and Charisma.

Some times characters won't be able to eat anything and will be forced to go long periods of time without food. This is dangerous and can result in the party rolling up new characters. An individual must make a successful check against his constitution after he has gone three days without meeting the minimal daily food requirements. A successful roll indicates that he remains healthy. Failure indicates that the person has become malnourished. All vital statistics are immediately reduced by 10 points (except I.Q. and Charisma). The effects of not eating are cumulative. Vital statistics continue to drop at a rate of 03% per day until he is fed. Whenever a PC loses more than 2/3 of his total constitution, he collapses and can't move. When constitution reaches zero, the person expires.

## WATER

All living things in the universe need the life giving touch of water to survive. Nothing can live without it. Like food, water is expressed in units. All Humanoid types must consume 3 units of water a day. Pythons and Mazian must consume 12. Water may be rationed like food. When rationing, humanoids must drink 2 units, Pythons and Mazian must ingest 8. At any time that a character doesn't drink the minimum requirements for rationing, he or she must make a constitution check. Failure indicates that the character has become dehydrated. Dehydrated individuals immediately reduce all vital statistics by 10 points. Each day that an individual goes without drinking, his vital statistics are reduced by another 05 points. The effects are cumulative and treated exactly as with food requirements above.

## SLEEP

Make them sleep. And a lot too. "I can go 3 days on four hours sleep" is total garbage! All humanoid types require a minimum of 6 hours of "good" sleep per solar day. Pythons, Phentari, Eridani, and Mutzachan races need only 4 hours. Good sleep is defined as uninterrupted sleep in some comfortable position. An additional 2 hours is added to the required time if the individual is wearing any type of armor, or has his sleep continually interrupted. If an individual doesn't get "good sleep," he adds +1 to die rolls when determining initiative and reaction time. Each day that an individual doesn't get good sleep, another +1 is added to the rolls. In order to recover from lack of sleep, a character must sleep for an uninterrupted 10 hours.

A character may attempt to stay awake indefinitely. The only problem is that it won't work. Humanoids can go 40 hours without sleep under normal conditions, Python and Phentari 60 hours. Eridani are just too stubborn and can go 72 hours without rest. For every hour past the allowed limits, there is a 5% cumulative chance of the "stressed out" individual passing out.

## MONSTERS

There are millions and millions of things in the universe, malevolent and dangerous. The Biological Catalog Agency has recorded over 2,000,000 life forms considered hazardous to Alliance personnel. Probably none is more evil and threatening to the existence of life as we know it, than Uncle Ernie Freiberg.

Uncle Ernie is the richest man in the universe, valued at over 30,000,000,000,000cr. He is also the greatest Bio-genetic cybernetic scientist that has ever lived. His breakthrough in the field of artificial intelligence mapping, revolutionized science as we know it. He devised brilliant ways to interface artificial intelligence with the brain and thus wrought his fortunes. In 2256, in a major dispute with the government over licensing, Uncle Ernie went sour and he quit his post as Chairman of Universal Field of Science Research at Berkeley California. In a verbal tirade, he accused the government of duplicity and fraud. He screamed of secret experiments going on to produce perfect Cyborgs, to replace most Alliance personnel. He was arrested for Treason and thrown in jail for life.

In 2267, Uncle Ernie escaped from the maximum security prison on New Leavenworth. Six months later the Alliance felt his wrath as Uncle Ernie unleashed a bio-genetically engineered creature on New Washington. It came to be known as a Blood Warlock which slaughtered two and a half million people before the military could finally destroy it. Next, he killed another 350,000 with a biological attack on the planet Malnax 7. Uncle Ernie claims that he will bring the Alliance to its knees by destroying the universe that it lives in.

He formed the Anarchist Rebellion Movement (ARM), drawing thousands of disillusioned and disgruntled people to take up his bidding. The ARM swung and the Alliance cringed with fear. The ARM builds, discovers, hunts, trades, and researches dangerous lifeforms. It methodically runs its finger through all the galaxies, randomly distributing "Death" to the corners of the universe, selling monsters wholesale to the highest bidder. It has raised a powerful

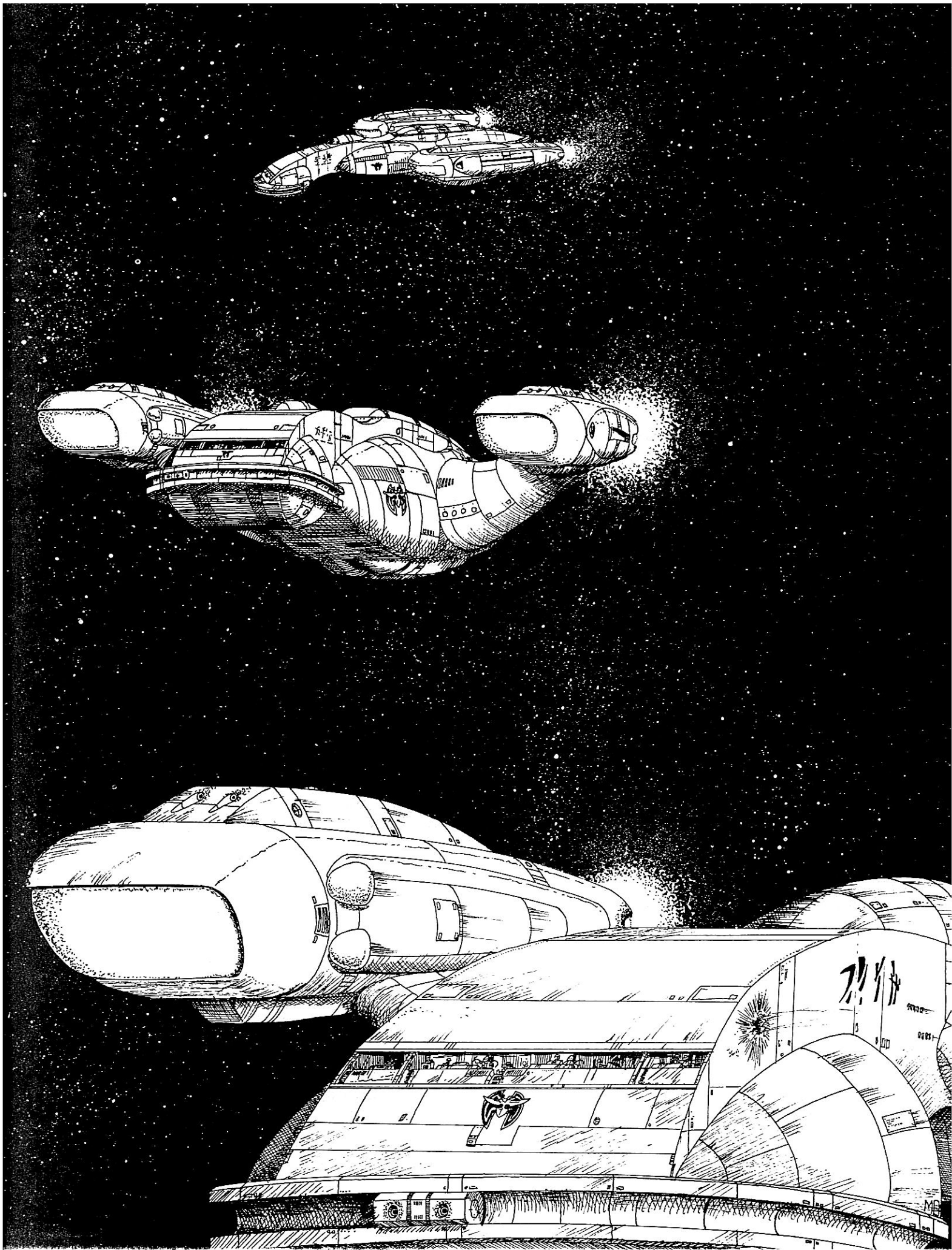

navy, built secret bases, and has dug its fingers into various Alliance sub-governments. The ARM also works with the Rebels. Uncle Ernie proudly calls his legions of death and destruction, "Uncle Ernie's Merchants of Doom."

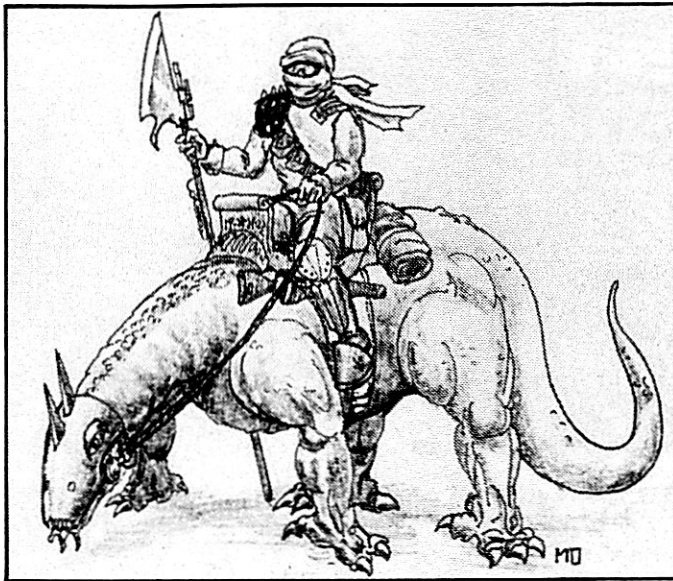

**AGITATOR**

Habitat: Unknown	# of Attacks: 1
Planet Origin: Unknown	Damage: Variable
No# Appearing: 1	Attack %: Special
Body Points: Unknown	Special Attacks: Mental Disruption
Movement: Unknown	Special Defenses: N/A
Threshold: Nil	I.Q.: Unknown
Initiative Mod: Automatic	Experience: 1500
Defensive Mod: Nil	

There exists a strange phenomena throughout the matrix controlling community. All types of matrix controllers have reported encountering a presence that they commonly call an Agitator. The presence was so strong that it forced them to lose concentration, consequently voiding the generation process. Individuals attacked by an Agitator must make a successful Intuition check at a +35 to the dice roll or fail to properly generate. All power used to generate the matrix is also lost. This effect continues for as long as the matrix controller attempts to generate.

There is some contention that Agitators are aroused by the psychic patterns produced when matrix controllers become angered or frightened. Individuals claim that those persons who were able to remain calm did not have their powers affected. Characters who successfully roll under their Aggression scores are not affected. They must make new Aggression checks every minute while engaged in combat or under stress.

**THE ARACHNID PRESENCE**

Everyone run to the hills cuz the Arachnids are coming. They're back and they are not "playing". The last time they were here, they soaked up 05% of Alliance territory before they were stopped. It cost the Alliance 257 ships, 75 planets, and millions of military and civilian casualties. This is their third trip and reports claim that they are serious as !\*%&%.

The threat has grown exponentially. First, the Arachnids seem to have rectified the problem of fighter spacecraft and currently field 2 different types of attack shuttles. Their navy has grown significantly in numbers: No less than 150 different vessels have been sighted. Reports verify that this is merely the first wave.

If accounts are true, then we are all in BIG trouble! Here are some advance reports on the spiders. These accounts are speculative and have not been verified yet, so don't take them as complete or correct.

**ARACHNID**

Habitat: Any	# of Attacks: 4 claw+1 bite
Planet Origin: Unknown	Damage: 2-8 x 4/1-4
No# Appearing: 1-10	Attack %: 95
Body Points: 60-100	Special Attacks: See Below
Movement: 7	Special Defenses: See Below
Threshold: 4	I.Q.: 120+
Initiative: See Below	Experience: 15,000
Defensive Mod: +20	

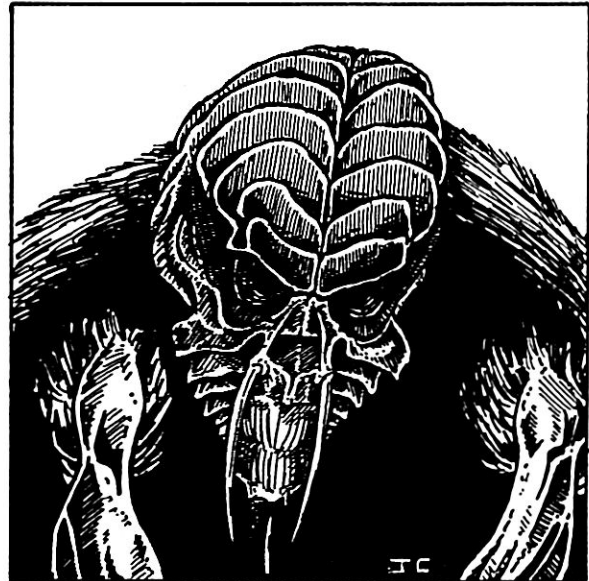

The Arachnids are by far the most formidable adversaries that the Alliance has run into in force. They are malicious, and the exact intent of their presence in the galaxies is unknown at this time. It is believed that the spiders are mounting a major offensive throughout the galaxies. Alliance units have encountered large forces in Fornax, Carina, and the Greater Magellanic Cloud. The stargate at Carina has been destroyed and that entire galaxy cut off from the rest of the Alliance. Alliance president William Mayer has convened an emergency meeting of the Council of Timar to analyze the overall military situation. All sovereign nations have been alerted and defense fleets put to the field.

The Arachnid is a large, spider-like being, believed to be indigenous to the Canes Venacti Super Cluster. It is huge, tipping the scales at over half a ton. An Arachnid stands over 3m in height. Bodies recovered by the Defense Department suggest that these beings have 60-100 body points. Archaic Powder and Hand Held weapons do 1/2 damage to spiders because of their tough exoskeleton. This mighty nemesis attacks 5 times per melee segment, doing 4 claw attacks for 2-8 damage, and one bite for 1-4 points (strength bonus already applied). Arachnids are also quite capable of using weaponry and carry a strange, conical shaped energy device that does 4-24 points of damage (treat as a particle weapon). Attack rolls: 130/100/80/50/20/00.

The Arachnids possess several special attack forms. Some Arachnids possess matrix controller powers (20%). Worse yet, of the 20% that possess the power to generate, 45% are double classed matrix controllers and 10% are triple classed. An Arachnid can also fire a thick viscous globular web from its mouth which immobilizes any individual that it hits. The spider has a 95/75/30/05 percent chance to hit someone within the maximum range of 50m. All individuals who are struck by the web must make a strength check at -70 or be completely immobilized. The web can be cut easily with energy weapons, as long as the person has a free arm. The physical statistics of the Arachnids are superior to any of Alliance personnel. They have a 4 point threshold carapace.

**BLIP**

Habitat: Air  
 Planet Origin: Trishmag  
 No# Appearing: 2-12  
 Body Points: 1-6  
 Movement: 20

# of Attacks: 1  
 Damage: 3-18  
 Attack %: 105  
 Special Attacks: Electrical attack  
 Special Defense: Immune to energy.  
 Kinetic attacks do 1/2 damage.  
 I.Q.: 60-80  
 Experience: 2500

Threshold: Nil  
 Initiative Mod: -4  
 Defensive Mod: +50

Blips are mainly indigenous to the Trishmag star system. They have since been randomly transported all over the galaxies by the Anarchists. Scientists are baffled as to what these creatures are. They have been captured, yet they expire in a relatively short time. They have only been observed, outside of Trishmag, on worlds where the atmospheric ionization potential is high. They commonly appear in lightning storms as balls of energy and attack persons utilizing any electrical apparatus. The attack of a Blip produces 3-18 points worth of electrical damage.

Mutzachans love to chase the "lightning bugs" around, attempting to get zapped by one. Bug hunting is a favorite sport of Mutzachan youth.

**HABERDINE'S WARRIOR**

Habitat: Any  
 Planet Origin: Anarchist  
 No# Appearing: 1-6  
 Body Points: 8+d8  
 Movement: 12  
 Threshold: 2  
 Initiative: -4  
 Defensive Mod: Nil

# of Attacks: 2  
 Damage: 2-12  
 Attack %: 70  
 Special Attacks: Nil  
 Special Defenses: Nil  
 I.Q.: 40-75  
 Experience: 600



The result of a bio-genetic experiment gone awry. Amil Haberdine was a prominent bio-geneticist who worked commonly with Uncle Ernie Freiberg when Ernie was the most respected scientist in the universe. Haberdine was working to cross breed a Python Lizard with a Gen-Human when things went bad. The mutated human/crocodile-like monster got loose and killed the professor and his 3 assistants. When Ernie went sour, he dug up Haberdine's old papers and redesigned the monster to be an effective and fearsome weapon against the Alliance.

The Haberdine attacks with razor sharp claws that do 2-12 points of damage at a level 5 Hand To Hand proficiency. It attacks in a berserk rage without fear of bodily damage, remaining conscious to -6 body points. The creature has a 2 point body threshold. It swims with 12th level proficiency and climbs at level 9. Its preferred form of attack is waiting till fog falls on the swamp then rushing out to devour its prey, gaining a -4 to initiative rolls.

It is super cunning, with a 100 Intuition or higher.

**MAXTERON COMMUNE**

Habitat: Radiation  
 Planet Origin: Trishmag  
 No# Appearing: 2-8  
 Body Points: 4+d8  
 Movement: 12  
 Threshold: Nil  
 Initiative: Nil  
 Defensive Mod: -10

# of Attacks: 1/6 seconds  
 Damage: 4-16  
 Attack %: 75%  
 Special Attacks: Energy blast  
 Special Defenses: See Below  
 I.Q.: 40-60  
 Experience: 5000

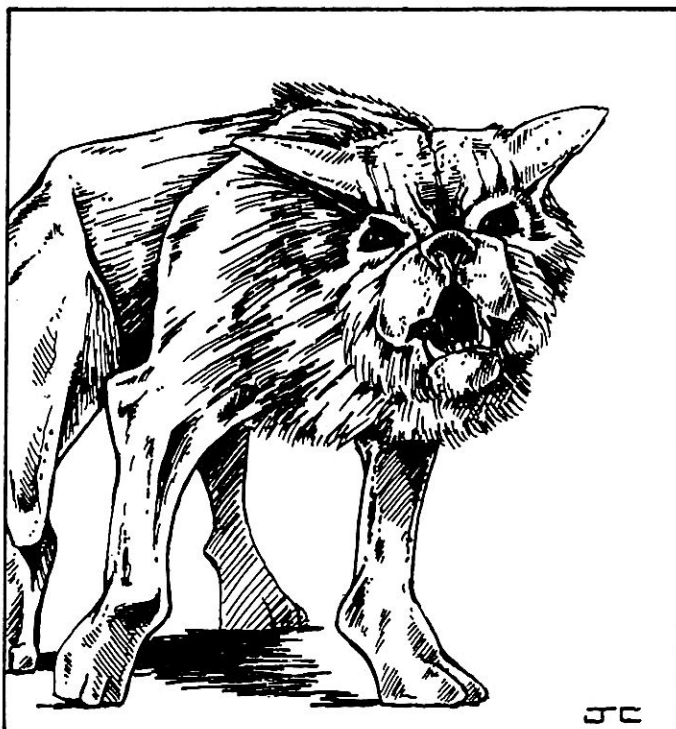

These beings are indigenous to radiation environments and have been the bane of Mutzachan existence for eons. The commune consists of 2-8 dog-like beings that appear as shimmering energy, almost translucent. The commune acts singularly, attacking as one without fear. Each being can generate an energy cloud that does 4-16 points of damage out to range bracket 4 with 75% accuracy. Each dog can generate the fog 3 times per day.

The commune can detect energy sources, common in weapons such as plasma and Omega weapons, out to 5000m, and will try to take them for food. Mutzachans are a cherished treat to these beings who communicate telepathically. If the weapons and sources are left for them, the Commune will not attack, draining the objects then leaving.

**METAL VIRUS**

Habitat: Oxygen  
 Planet Origin: Neendras 3  
 No# Appearing: 1  
 Body Points: 1  
 Movement: 10  
 Threshold: Nil  
 Initiative: 99% surprise  
 Defensive Mod: Nil

NO# Attacks: 1  
 Damage/Attack: Special  
 Attack Number: 90  
 Special Attacks: Dissolve Metal  
 Special Defenses: size  
 I.Q.: Nil  
 Experience: 200



Metal virus are much more common than first expected. They are indigenous to most high metal concentrate worlds. Anarchists have recently developed the method to transport the virus which is an airborne cloud of micro-organisms. The cloud is semi-sentient and attacks metal objects, destroying 1-4 points of armor integrity in each section of the armor per minute of exposure. Armor begins to turn white as it decays. The only way to detect a metal virus is by using an Infrared Discriminator. An alcohol spray drives off the virus. A blast of heat, such as that from a flamethrower will also destroy it.

**QUICKSOIL**

Habitat: Oxygen base  
 Planet Origin: Synthetic  
 No# Appearing: 1  
 Body Points: 500  
 Movement: 1m/hour  
 Threshold: N/A  
 Initiative Mod: Nil  
 Defensive Mod: Nil

NO# Attacks: Special  
 Damage/Attack: Special  
 Attack Number: Special  
 Special Attacks: See Below  
 Special Defenses: Lasers: 1/2 dam.  
 Arch. powder weapons do no dam.  
 I.Q.: Average  
 Experience: 350

Quicksoil is living quicksand, a big seller at underground Anarchist conventions. The soil cost a mere 1000cr per 50 cubic feet of material. Quicksoil is actually a living intelligent biological organism that moves about, luring unsuspecting victims to their death. The soil acts as quicksand and those persons who are unlikely to spot the organism fall into it and are digested over a couple of months or so. By the way, a person wearing body armor sinks like a rock and drowns when his air intakes clog or his oxygen supply runs out. Otherwise, personnel who don't panic remain afloat indefinitely. Characters must make a successful Aggression check at a -35 or panic. Due to the nature of Quicksoil, normal kinetic attacks do no damage and lasers only do half. Plasma and fire do triple damage.

**RENDER**

Habitat: Any  
 Planet Origin: Motaran Rift  
 No# Appearing: 1-4  
 Body Points: 2-12  
 Movement: 10  
 Threshold: Nil  
 Initiative: -5  
 Defensive Mod: -15

# of Attacks: 1  
 Damage: 2-12  
 Attack %: 80  
 Special Attacks: See Below  
 Special Defenses: See Below  
 I.Q.: Unknown  
 Experience: 3000



One of the most horrible monsters imaginable. The Render comes from the Void, the nebulous, undefined space of the Motaran Rift. The being is capable of dimensional travel and attacks as such. The warning of its coming is a high pitched wail that rends the soul. Hence, the name. Persons must make an Aggression check at a -25 penalty or be struck dumb with fear for 2-8 minutes.

The Render first appears as a semi-transparent amorphous blob, only visible in the ultra-violet spectrum. It can pass through all armor unaffected, then materialize inside the suit and attack the person, ripping pieces of flesh from the body. Each hand to hand melee segment it does 2-12 points of damage randomly to the body. It can be killed by normal means and once it attacks, can not invoke dimension travel for 3-18 seconds.

Eridani call it the Ma-Nal-Adwarises, the beast of a 1000 teeth.

**RNJARRA (cold cloud)**

Habitat: Methane  
 Planet Origin: Methane  
 No# Appearing: 1-2  
 Body Points: 40+d10  
 Movement: 15  
 Threshold: N/A  
 Initiative Mod: -2  
 Defensive Mod: -25

NO# Attacks: 1  
 Damage/Attack: Special  
 Attack Number: 85  
 Special Attacks: Cold  
 Special Defenses: See Below  
 I.Q.: Unknown  
 Experience: 1000

Rnjarra is the Eridani word for Cold Cloud. Rnjarra are indigenous to most methane planets. They exist as negative energy, a black cloud of nothingness that continually produce powerful endothermic reactions. The cold cloud attacks by surrounding a victim then draining its body of heat. Each attack does 3-12 points of cold damage. Armor must make an SMR vs cold or the absorption polymers suffer damage. Archaic weapons do no damage to the Rnjarra as it has no corporeal form. All heat based attacks affect the beast normally.

**STAR TROLL**

Habitat: Oxygen  
 Planet Origin: LTV-309  
 No# Appearing: 1-8  
 Body Points: 20+2d10  
 Movement: 8  
 Threshold: 2  
 Initiative: Nil  
 Defensive Mod: +20

NO# Attacks: By weapon  
 Damage/Attack: By weapon  
 Attack Number: By weapon  
 Special Attacks: Fear  
 Special Defenses: Regeneration  
 I.Q.: 40-60  
 Experience Points: 1000



The Anarchists are busy transporting these evil beings all over the galaxies. The Star Troll is a 4m tall monster, indigenous to the mountains of LTV-309. Star Trolls are malicious evil creatures, intelligent and cunning. Each is trained to use any one weapon system and employs it at 4-8 levels of proficiency. In hand to hand combat, Star Trolls lash out with their powerful fists, doing 1-6 points of real damage. Its puss filled, festering face instills fear into its victims and persons must make an Aggression check at a -15 or flee. Failure to make an Aggression check by 20 points or higher, indicates that the person is frozen, rigid with fear.

Star Trolls regenerate at 1 point every six seconds and killing these beings can be quite difficult. Alliance scientists are currently studying this strange regenerative process and offer 10,000cr for any Star Troll brought in alive.

**SHADOW**

Habitat: Any  
 Planet Origin: Unknown  
 No# Appearing: 1-4  
 Body Points: 2-12  
 Movement: 6  
 Threshold: Nil  
 Initiative: -6  
 Defensive Mod: Nil

# of Attacks: 1  
 Damage: Special  
 Attack %: 65  
 Special Attacks: Body Drain  
 Special Defenses: See Below  
 I.Q.: 120-150  
 Experience: 1000



Scientists claim these monsters to be nothing more than psycho-kinetic distortions that are no threat to anyone at all. Well, how come so many victims have raved about a shadow like being that emits a soft whining noise when it approaches, then surrounds the person draining him of strength and constitution until he expires?

Chatilians claim that the Shadow is an inter-dimensional being that feeds on psychic forces. Scientists dismiss this theory as hogwash.

The Shadow attacks, draining 1-4 points of constitution and strength permanently per HTH round. They are only affected by empathic powers or intense light. Shadows move slow and persons can escape by running. Thus these beings tend to corner their victims in alleyways before attacking. Bright light seems to banish them.

For all intents and purposes, there are an unlimited amount of different alien lifeforms in the universe. You can create almost anything you want. Aliens are assigned an experience point value. The value depends on the abilities of the creature. Be careful though. Limit the monster's abilities, otherwise your monster will destroy the entire party. Below, I have provided a method for rolling up your own monsters.

- |   |   |  |  |
|---|---|--|--|
| <p><b>TABLE 1<br/>PHYSIOLOGY</b></p> <ol style="list-style-type: none"> <li>1. Non-corporeal</li> <li>2. Amorphous</li> <li>3. Avian</li> <li>4. Canine</li> <li>5. Crustacean</li> <li>6. Energy</li> <li>7. Feline</li> <li>8. Fish</li> <li>9. Herd Animal</li> <li>10. Humanoid</li> <li>11. Insectoid</li> <li>12. Invertebrate</li> <li>13. Plant</li> <li>14. Reptilian</li> <li>15. Rodent</li> <li>16. Serpentine</li> <li>17. Transcorporeal</li> <li>18. Xenomorph</li> <li>19. Special</li> </ol> | <p><b>TABLE 2<br/>SIZE</b></p> <ol style="list-style-type: none"> <li>1-2 Small</li> <li>3-6 Average</li> <li>7-8 Large</li> <li>8+ Huge</li> </ol>   | <p><b>TABLE 3<br/>FACE</b></p> <ol style="list-style-type: none"> <li>1. Beady</li> <li>2. Empty</li> <li>3. Flat</li> <li>4. Large, Round</li> <li>5. Multiple</li> <li>6. Slanted</li> <li>7. Stalks</li> <li>8. Veiled</li> </ol>   | <p><b>TABLE 4<br/>MOUTH</b></p> <ol style="list-style-type: none"> <li>1. Bristle teeth</li> <li>2. Double Jaw</li> <li>3. Extended Jaw</li> <li>4. Fanged</li> <li>5. Membrane</li> <li>6. Sucker-like</li> <li>7. Toothed (large)</li> <li>8. Toothed (small)</li> </ol> |
| <p><b>TABLE 5<br/>SKIN</b></p> <ol style="list-style-type: none"> <li>1. Blistered</li> <li>2. Festering</li> <li>3. Oozing</li> <li>4. Ridged</li> <li>5. Rotting</li> <li>6. Scaly</li> <li>7. Slimy</li> <li>8. Smooth</li> <li>9. Warts</li> </ol>  | <p><b>TABLE 6<br/>ODD TRAITS</b></p> <ol style="list-style-type: none"> <li>1. Mane</li> <li>2. Mult. Arms</li> <li>3. Mult. Legs</li> <li>4. Stinger</li> <li>5. Suction Cups</li> <li>6. Tail</li> <li>7. Tentacles</li> <li>8. Wings</li> </ol>              | <p><b>TABLE 7<br/>DISPOSITION</b></p> <ol style="list-style-type: none"> <li>1. Aggressive</li> <li>2. Cautious</li> <li>3. Fearful</li> <li>4. Friendly</li> </ol>  |  |
| <p><b>TABLE 8<br/>EATING HABITS</b></p> <ol style="list-style-type: none"> <li>1. Carnivore</li> <li>2. Omnivore</li> <li>3. Herbivore</li> <li>4. Energy</li> </ol>  | <p><b>TABLE 9<br/>ATTACKS</b></p> <ol style="list-style-type: none"> <li>1. Acid</li> <li>2. Biological</li> <li>3. Chemical</li> <li>4. Constriction</li> <li>5. Electrical</li> <li>6. Fire</li> <li>7. Cold</li> <li>8. Poison</li> <li>9. Powers</li> </ol> | <p><b>TABLE 10<br/>DEFENSES</b></p> <ol style="list-style-type: none"> <li>1. Kinetic Shield</li> <li>2. Plasma Shield</li> <li>3. Optics Shield</li> <li>4. Sonic Shield</li> <li>5. Immune to Poisons</li> <li>6. Immune to Fire</li> <li>7. Immune to Acids</li> <li>8. Immune to Chem.</li> <li>9. Immune to Mental</li> <li>10. Cold</li> <li>11. Threshold</li> <li>12. Immune to bullets (like any good alien)</li> </ol> | <p><b>TABLE 11<br/>MANEUVERS</b></p> <ol style="list-style-type: none"> <li>1. Fly</li> <li>2. Swim</li> <li>3. Displace</li> <li>4. Molecular Dispersion</li> <li>5. Alter Form</li> <li>6. Burrow</li> <li>7. Dimension Travel</li> </ol>                                |

**STRUCTURES**

All objects have a Structural Integrity as well as a Threshold Rating. The Structural Integrity of an object represents the amount of total damage that can be done to the structure before it is completely destroyed. Threshold rating denotes how much instantaneous damage that an object can receive before it is penetrated. Archaic hand weapons do less damage to structures. All damage done by these weapons is considered to be 1/3 of stated damage. Any time that a structure receives more than 2/3 of it's total integrity, assume that a hole has been made in the structure. Given below are objects and their relative Structural and Threshold ratings.

Structural Integrity = SI, Threshold Rating = TR

Object	SI	TR
Door (Oak)	20	1
Door (Ironwood)	35	2
Door (steel)	50	4
Door (Flex Steel)	150	7
Wall (sheet rock)	40	1
Wall (brick)	250	3
Wall (wood)	150	2
Wall (Steel)	500	4
Wall (Flex Steel)	1000	7
Wall (Titanium Steel)	800	5
Wall (Ditanium Steel)	1500	20
Wall (Concrete)	200	3
Wall (Transparent Aluminum)	200	30
Top Soil (per 2.5cm)	-	1
Clay (per 1in)	-	1
Glass Window (normal)	2	-
Super Plex Glass (1m x 1m)	3	3
Flexor Glass (1m x 1m)	5	4

**MULTIPLIERS**

- Extensive Bracing x 1.4
- Per extra 3cm of thickness x 1.1
- Door: Assumes a 5cm thick door without any special braces
- Wall: Assumes a 10cm in thick wall with normal bracing

**TREASURE**

Parties eventually will stumble upon or locate weapons caches in the course of their adventuring. The type of treasure found depends on the technological level of the surroundings. The various levels of scientific achievement are rated on a scale of 1-6 Tech. A Tech Level 1 society would use archaic hand weapons, along with such things as plate armor. The most advanced tech societies use Omega class heavy weaponry and remote control robots.

The Galactic Alliance follows a controversial policy of Cultural Progression. Cultural Progression advocates the advancement of cultures through technical provisions. Corporations may legally provide technology to newly discovered peoples. They are able to freely sell or trade any product that is of the same technical level as those people receiving the goods. They may not trade, sell, or donate any technology of a more advanced level, but may provide less sophisticated technology. This ideal philosophy promotes the spirit of free competition amongst business while at the same time aiding those inferior cultures struggling to evolve.

**VALUABLE COMMODITIES**

VALUABLE COMMODITIES	COST
Benjari (slave)	5000cr/ea
Cashou (slave)	2400cr/ea
Wakon (slave)	1000cr/ea
Zendarean (slave)	6500cr/ea
Sange Nectar	20,000cr/1ltr
Blue Star Crystals	3500cr/ea
Red Star Crystals	5000cr/ea
Keltirinn ice	350cr/kg
Chiata	1000cr/ea
Puchoun Cat	1500cr/ea
Velkin Silks	2500cr/ea
Silk of Tamarias	8000cr/ea
Terran-eart Wine	2000cr/case
Machin Cognac	35,000cr/case
Fontain Chablis	55,000cr/case
Raj Lizard Skins	2000cr/ea

**TRADE ITEMS**

Player characters may find the need to trade items in order to make some money. They may own giant mega-corporations that trade in goods and services. The following table lists the most common goods

available on the market. Choose an item that you intend to buy. COST represents the general cost of the item per unit purchased. VOLUME equals the amount of cargo space that the item takes up. VAR RANGE equals the maximum fluctuation in the price of the good. FIXED, GAIN, and LOSS represent the percentage chance that the price of the good will vary.

**Example:** Henry the Mutzachan wants to purchase 1000 units of meat for his Bohemian star-freighter. He intends to sell it on Taos 4. The cost to purchase 1000 units of meat is  $1000 \times 10 = 10,000cr$ . The volume of space required to store the food equals  $1000 \times 3 = 3000$  units of space. A Bohemian class star-freighter has a maximum cargo capacity of 100,000 units. So there is plenty of room on board to store the meat. Henry transports the meat to Taos 4 where he sells it. To determine how much money he got for the meat, percentile dice are rolled. The result is a 57. There is a gain on the sale of the meat. Next the Variable Range Index is consulted. Meat has a variable range index of 0.6, so a d6 is rolled to determine the amount of variance. A 4 is rolled. To determine how much money Henry gained, multiply 4 times the total cost of goods purchased.  $0.4 \times 10,000 = 4000cr$ . Henry made a gross 4000cr profit off the sale of the goods.

ITEM	PROFIT			VOL	COST	VAR. RANGE
	FIXED	GAIN	LOSS			
Grain	01-80	81-95	96-100	2	3	0.4
Milk	01-75	76-95	96-100	2	5	0.4
Meat	01-10	11-80	81-100	3	10	0.6
Textiles	01-70	71-93	94-100	10	50	0.8
Minerals	01-55	56-85	86-100	10	75	0.8
Alloys (low)	01-60	61-85	86-100	15	100	0.8
Alloys (high)	01-40	41-80	81-100	15	150	1.0
Luxuries	01-50	51-90	91-100	.2	300	1.2
Machinery	01-65	66-92	93-100	100	100	1.0
Computers	01-40	41-80	81-100	50	200	1.2
AI	01-35	36-80	81-100	20	5000	1.0
Water	01-80	81-95	95-100	1	1	0.4
Gold	01-30	31-85	86-100	10	250	1.0
Processors	01-60	61-90	91-100	2000	8000	0.4

**ENCUMBRANCE**

Player characters usually have a pressing need to carry large amounts of equipment on their person when adventuring. Everything carried has weight and most things have substantial volume. Encumbrance measures the amount of equipment that one can carry relative to his or her strength score. Too much equipment can severely restrict movement. Something need not necessarily be heavy to be cumbersome. Large, bulky objects are difficult to carry and also restrict movement.

Encumbrance has a pronounced effect on initiative and reaction modifiers. Lightly encumbered individuals suffer a penalty modifier of +1 to initiative rolls, moderately encumbered +2, and heavily encumbered, +4. The effects of encumbrance on movement are -10%, -33%, and -66% to light, moderate, and heavy encumbrance, respectively.

**Example:** Henry the Mutzachan has a strength of 49. Henry can carry up to 12.5lbs without being encumbered. He becomes lightly encumbered if he carries 12.5-25lbs, moderately encumbered carrying 25-60lb, and heavily encumbered carrying anything between 60-100lbs. Again, bulk affects encumbrance also.

**COMMUNICATION**

The intent of enemy and potentially friendly forces is determined through some medium of communication. All characters begin the game with proficiency in Earth English as well as their native language. They can communicate among themselves, but not necessarily with anyone else. If an encounter occurs with an alien lifeform, player characters may attempt communication through hand gestures or some other action of a peaceful nature. This does not automatically mean that the action will be interpreted as such.

## LIGHT

Players often find the need to move around in the dark and need light sources to aid them. They may wish to map out underground areas or simply look for some lost item. The Cizerack have the natural ability to see clearly in the dark. The cats see by light amplification, or what is known as night-vision. The Eridani and Python races can spot heat emitting sources in the dark. This ability is called infravision.

Light generating devices function for a certain period of time before they run out of fuel. Using light sources at night can be perilous. The following table provides information about various light sources. The table lists the radius of illumination, duration of the light source, and the modifier applied to sighting checks when operating in normal darkness.

SOURCE	ILLUMINATION	TIME	MOD
Flashlight	10m line	6hr	+08%
Flashlight (Threader)	23m line	8hr	+02%
Lantern	15m rad	4hr	+15%
Lantern (bullseye)	20m line	4hr	+05%
Torch	8m rad	2hr	+15%
Fire (small)	10m rad	var	+30%
Fire (large)	27m rad	var	+60%
Glowbar	3m rad	1hr	+01%
Light Sword	6m rad	1hr	+12%
Light Matrix	13m rad	5min	+18%

## INFRAVISION

Infravision is the ability to see the infrared portion of the electromagnetic spectrum. All living objects radiate heat. The relative differences in temperature between objects can be readily discerned. Objects that radiate high ambient temperatures appear brighter than those of lower temperature. Bright objects are seen as red, while cold objects appear blue or black. Cold blooded creatures radiate very little heat since their body remains at the same temperature as their surroundings. NOTE!! Characters often mask their body so as to not be detectable. This is done by covering oneself with something that radiates no heat.

**Example:** A character in a swamp could cover himself with mud, in order to avoid infrared detection.

Infrared sighted races may be temporarily blinded by extremely "hot" sources. Stumbling upon a campfire at night will temporarily blind an infravision user. The effect is like looking directly into the sun. The normal range for infravision is 50m.

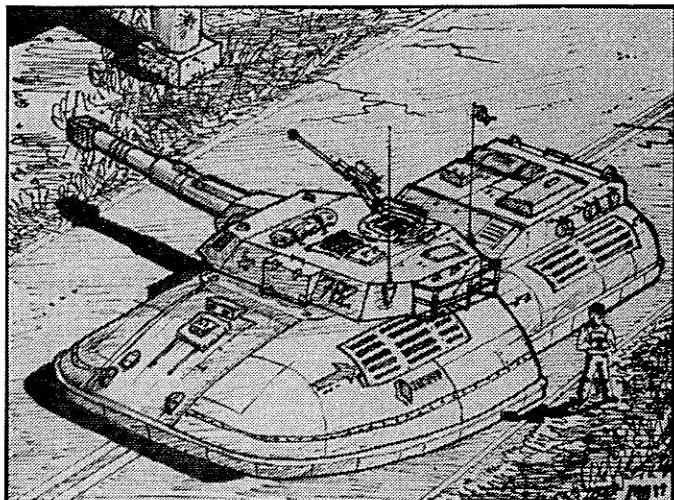

## NIGHT VISION

Individuals with night vision are able to see normally in daylight as well as night. Persons with night vision amplify existing ambient light sources so they can see. The normal range of night vision is about 50m.

## ULTRA-VISION

Ultra-Violet sighting devices can allow an individual to see during the night time. Reason: There is a continuous stream of incoming ultra-violet radiation at all times. Ultra-Vision devices amplify this existing ambient light source, and convert it into a visible image so the user can see. The normal range of ultra-vision is 20m.

## MOVEMENT

The movement rate for a character is given under the vital statistics section of the character sheet. There are three different numbers shown. The first number represents the distance that a character can run in a second. He can do so for up to 60 seconds, without incurring a fatigue penalty. The second number represents the number of kilometers that the individual can walk in an hour at a normal pace. Again, most characters won't need to walk continuously longer than an hour. Should someone need to walk for extended periods of time, he can do so continuously for up to four hours, without incurring any fatigue penalties.

The third number represents the distance that a character can walk in a day. An individual can force march beyond the distance that his normal movement rate allows, up to 50% further, incurring a fatigue penalty of -20 to constitution, strength, and agility, until constitution reaches zero.

There are certain modifiers that restrict or facilitate movement such as terrain features, weather, or encumbrance. Players should be aware of these problems, so as to avoid potentially dangerous situations arising from the inability to move about freely.

### MOVEMENT MODIFIERS

Paved Road	+50%	Wind Speed 40-88kph	-25%
Foot Path	+25%	Wind Speed 89-94kph	-50%
Heavy Foliage	-50%	Wind speed 95-120kph	-75%
Hills	-25%	Wind speed over 120kph	None
Mountains	-50%	Light Encumbrance	-10%
Moderate Rain	-25%	Moderate Encumbrance	-33%
Heavy Rain	-50%	Heavy Encumbrance	-66%

**NOTE!** The effects of these modifiers are cumulative.

**Example:** Henry the Mutzachan is trying to move about in the mountains. The winter winds are gusting out of the East at over 150 kilometers per hour. Henry is actually being blown around like a tumble weed. One thing we know for certain is that he definitely isn't walking anywhere fast.

## FINDING THE TREASURE STASH

All adventurers seek to find the golden treasure chest filled to the brim with precious gems and other riches beyond their wildest dreams. But most of the treasure found isn't gold or gems, but weapons caches, expensive electronic equipment, etc. Much is taken from slain adversaries or accidentally discovered through fortuitous events. There also exist "magical" items, forged by the wise and the wicked. Characters who find these mystical and dangerous devices, should use discretion and not talk openly of them. Otherwise, they are liable to wake up one morning with their throats cut.

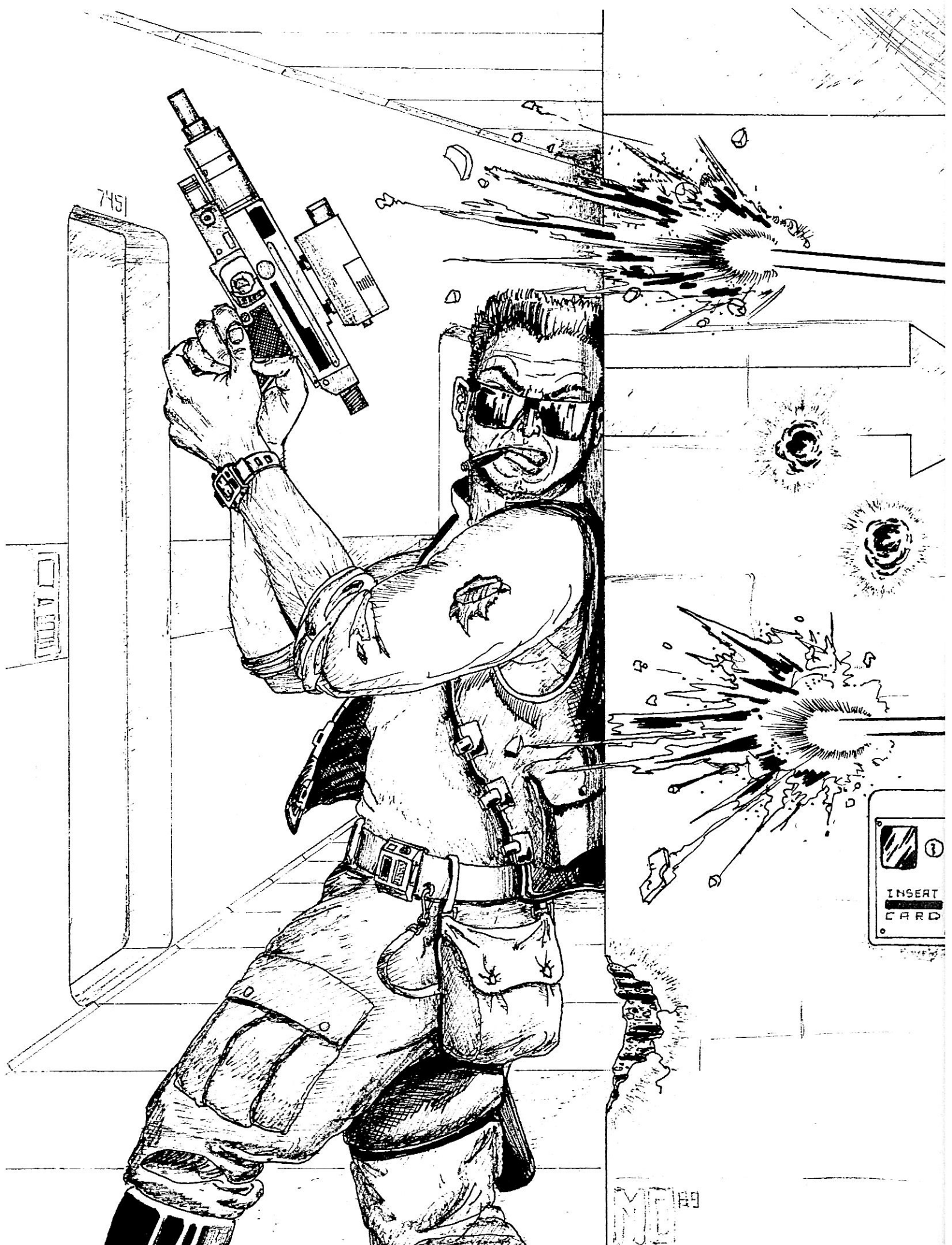

745

INSERT  
CARD

ME 89

## POWER UNITS

Power units are an arbitrary measure of energy for use in the game. Devices use power units up at set rates, depending on the device. As a general rule each unit would power a normal appliance for one minute. Here is a list of power units as they relate to charges for various devices:

SOURCE	POWER UNITS
Fire (camp)	1/10 per min
Electricity (house voltage)	1 per min
Car Battery	100 units
Mini Fusion Reactor	200 per hr
High Tension Wires	1000 per min
Main Fusion Reactor	10,000 per sec
Laser Weapons	1 per shot
Pulse Weapons	8 per shot
Omega Weapons	20 per shot
Disruptors	15 per shot
Disintegrators	25 per shot
Particle Weapons	3 per shot
Meson Cannons	50 per shot

## REGIONAL OFFICES

Company Infra-structure is quite important to characters whose lives often depend on the mother company to save them in times of peril. Company policies can have a severe impact on character advancement as well. Each company is broken down into regional, sector, and quadrant offices. It is assumed that beginning characters work for regional offices. A mega-corporation may have an overall operation policy that it employs. However, on a regional level, the local office dictates policy. Thus, operation procedures within a given company may differ drastically from one branch to another. Below are tables designed to provide information on regional office policies.

### HIERARCHIAL COMPANY STRUCTURE

01-50	Strict Chain of Command
51-80	Dual Reporting
81-100	Open Door Policy

**Note!!!** Strict chain of command means that personnel must go through their immediate supervisor to resolve problems. Dual reporting indicates that the character has two or more bosses at the same level of operations. He reports to both of them and receives instructions from either or both as the situation warrants. Open Door Policy allows unhappy personnel to walk into the regional president's office to get advice, resolve problems, etc.

### PRE-MISSION TRAINING (optional)

01-10	01-10 Points
11-20	11-20 points
21-70	Situation Dependent
71-100	No Pre-mission training

**Note!!!** Not used when playing modules.

**Note!!!** For every 5000 experience points possessed, subtract 1 from the dice roll.

### QUARTERLY TRAINING POLICY

01-65	5-10 skill points
66-80	10-15 skill points
81-90	15-20 skill points
91-100	No Extra training

**Note!!** Free training is used to upgrade the quality of company personnel.

### PAYROLL POLICY

01-50	Monthly
51-70	Bi-Weekly
71-95	Weekly
96-100	As Per Employee Needs

### PAYROLL POLICY 2

01-70	1 Week Advance Possible
71-85	2 Week Advance Possible
86-100	No Advance

### VACATION POLICY

01-30	1 Day Per Month
31-80	2 Days Per Month
81-95	3 Days Per Month
96-100	No Vacation

### VACATION POLICY 2

01-70	Paid Vacation
71-100	No Pay Vacation

### CREDIT CARD POLICY (automatic default coverage)

01-50	500cr starting limit
51-60	1000cr starting limit
61-70	2000cr starting limit
71-80	5000cr starting limit
81-100	No Issuance of Credit cards

### EQUIPMENT REPAIR POLICY

01-40	Replace 10% of damaged, lost or used equipment
41-50	Replace 20% of damaged, lost or used equipment
51-60	Replace 30% of damaged, lost or used equipment
61-70	Replace 40% of damaged, lost or used equipment
71-100	No Replacement

### CYBERNETIC ASSISTANCE POLICY

01-10	Replace lost limbs for free
11-50	Replace lost limbs/organs 10% discount
51-70	Replace lost limbs/organs 20% discount
71-75	Replace lost limbs/organs 30% discount
76-80	Replace lost limbs/organs 50% discount
81-85	Replace lost limbs/organs 75% discount
86-100	No Assistance

### CRIMINAL ASSISTANCE POLICY

01-20	No Assistance For Criminals
21-40	Lawyers provided: Pay docked slightly
41-100	Lawyers Provided: Pay docked severely

## THE BOSS

This guy can make you or break you. If the boss is "cool" than your life will be O.K. But if he is an @\*!?!#%, then your life might very well be short and miserable at the same time. Roll on the table below to determine the type of supervisor that the party must report to.

### EMPLOYER RACE TYPE

01-40	Gen-Human
41-60	Human
61-70	Eridani
71-80	Phentari
81-88	Python Lizard
89-93	Ram Python
94-98	Mutzachan
99-100	Other

**Note!** Can be modified due to special firm type.

**EMPLOYER PERSONALITY TABLE 1**

01-50	Disciplinarian
51-65	Flexible
66-80	Average
81-90	Easy Going
91-100	Lax

**EMPLOYER PERSONALITY TABLE 2**

01-70	Objective
71-100	Plays Favorites

**EMPLOYER PERSONALITY TABLE 3**

01-25	Above Reproach
26-35	Takes Bribes
36-40	Drinking Problem
41-60	Womanizer
61-70	Gives out Bonuses
71-75	Gambler
76-77	Rebel Spy
78-79	Arachnid Implant
80-81	Corporate Implant
82-83	Excellent Political Contacts
84-85	Excellent Network Contacts
86-100	Nothing Special

**RAPID DECOMPRESSION TABLE**

01-10	Constitution check every 5 minutes. Failure indicates loss of consciousness. 1 point of tissue damage per 2 minutes.
11-20	Constitution check every minute at -10 penalty. Death in 4-16 minutes. 1 point of tissue damage.
21-30	Dangerous Decompression. Constitution check at -20 penalty. 1-2 points of tissue damage per minute.
31-40	Violent Decompression. Con check every minute at -40. Death in 1-8 minutes. Objects take to the air. There is a 10% chance every 10 seconds of being struck by a flying object (1-3 points of damage). Victims must make a manual dexterity check at -20 penalty or slide toward the hole (1-2 meters per minute).
41-50	Constitution check every minute at -60 penalty. Death in 1-4 minutes. 25% Chance to be struck by a flying object (1-4 points of damage). Victims must make a man dex check at -40 penalty or slide toward the hole (1-4 meters per minute)
51-60	Constitution check every 30 seconds at -80 penalty. 2-8 points of tissue damage per 30 seconds. 50% Chance to be struck by a flying object (2-8 points of damage) Victims must make a manual dexterity check at a -80 penalty or slide toward the hole (1-6 meters per minute).
61-70	Extreme Decompression. Constitution check every 30 seconds at -100 penalty. Victims suffer 3-12 points of tissue damage per 30 seconds. 75% Chance to be struck by a flying object (3-12 points of damage). Victims must make a manual dexterity check at a -120 penalty or slide to the hole (2-8 meters per min).
71-80	Massive Decompression. Structural collapse (4-24 structural points per minute). Victims take 4-24 points of tissue damage per 10 seconds. 90% Chance to be struck by a flying object (4-24 points of damage). Victims slide toward the hole (3-12 meters per minute).
81-90	Aperture tear. Structural collapse at 10-60 points per minute. 10-60 points of tissue damage per 10 seconds. 10% chance to be sucked out per second.
91-100	Sucked out into deep space. Instantaneous death.

**MALFUNCTIONS**

All weapons malfunction from time to time. It has to happen eventually. Besides, we Battle Masters like it that way. Now the question seems to be, "What happens to the weapon when it malfunctions?" The answer: A lot of different things can happen to a weapon when it malfunctions. It depends on the weapon type and how seriously it is messed up. Below are listed the various problems that can arise when PCs roll a malfunction. Just roll on the appropriate table, based on the type of weapon that they *were* using.

**ARCHAIC HAND (drawstring)**

All Archaic drawstring weapons malfunction on a 100.

01-50	Misfire (arrow or bolt broken)
51-80	Drawstring snaps (did you remember that spare?)
81-90	Bow warps/cracks: -60 accuracy, malfunction is halved.
91-100	Breaks (buy a new weapon)

**MODERN ENERGY HAND WEAPONS**

01-70	Power fluctuation: Non-functional for 2-12 seconds
71-85	Weapon shorts out for 4-32 seconds.
86-90	Fuse is blown. Take it to the shop.
91	Power erratic: Weapon turns on and off 40% of time. Roll each time weapon is swung or is used to parry.
92-95	Overload: Brilliant light show on next impact +2 dmg.
96-97	Magnetic containment bottle is erratic: -30% attack.
98	Electrical short: Wielder takes 1-4 electrical damage.
99	Overload: All targets in 5m take double damage.
100	EXPLOSION: All targets in 10m take 4x damage and area is ionized and mildly radiated.

**ARCHAIC POWDER, DIRECT FIRE**

01-50	Jam, correction time: 2-12 seconds
51-80	Jam, correction time: 4-24 seconds
81-90	Jam, correction time: 6-36 seconds
91-95	Round stuck in chamber. Repair weapon skill needed.
96-97	Breaks (buy a new weapon)
98	Weapon magazine spring broken: Malfunction is halved
99	Weapon explodes (double base damage within 1m)
100	Weapon explodes (quadruple base damage within 3m)

**BEAM WEAPONS**

01-50	Jam, correction time: 2-12 seconds
51-70	Jam, correction time: 4-24 seconds
71-85	Jam, correction time: 6-36 seconds
86-88	Forward targeting mirrors misaligned, -20 to hit
89-90	Rear targeting mirrors misaligned, -40 to hit
91	A1 Targeting Card: Refinement mirror misaligned, weapon now does 1/2 damage
92	A1 Targeting Card: Refinement mirror broken, inoperable
93	A2 Function Card: Weapon can't fire on full auto
94	A2 Function Card: Weapon only fires on full auto
95	A2 Function Card: Weapon inoperable
96	A3 Output Card: Energy short. Shots use 2x charges
97	A3 Output Card: Complete energy short. Inoperable
98	A3 Output Card: Explodes (2x damage, 1m range)
99	A3 Output Card: Explodes (4x damage, 3m range)
100	A3 Output Card: Explodes (8x damage to 3m, 4x damage to 6m, 2x damage to 9m)

## PULSE, OMEGA, and ENERGY WEAPONS

01-50	Jam, correction time: 2-12 seconds
51-70	Jam, correction time: 4-24 seconds
71-80	Jam, correction time: 6-36 seconds
81-83	Forward targeting mirrors misaligned, -20 to hit
84-85	Rear targeting mirrors misaligned, -40 to hit
86	A1 Targeting Card: Refinement mirror misaligned, 1/2 damage on future shots.
87	A1 Targeting Card: Refinement mirror broken, weapon is totally inoperable
88	A2 Function Card: Weapon can't fire on full auto
89	A2 Function Card: Weapon only fires on full auto
90	A2 Function Card: Weapon inoperable.
91	A3 Output Card: Energy short. Shots use 2x charges
92	A3 Output Card: Complete energy short. Inoperable
93	A3 Output Card: Explodes (2x damage, 1m range)
94	A3 Output Card: Explodes (4x damage, 3m range)
95	A3 Output Card: Explodes (8x damage to 3m, 4x damage to 6m, 2x damage to 9m)
96	Suppressor Grid: Explodes (10x damage to 5m, 5x damage to 10m, 2.5x damage to 20m)
97	Electrical Short: 6-36 points of damage to welder
98	Reactor Breach: Radiation cloud dispersed
99	Reactor Critical: Emergency light just flickers, weapon still functions at 50% power.
100	Reactor Critical: Will explodes in 4-16 seconds. It takes 2-8 seconds to drop a weapon body harness. Explosion does 20x damage to 10m, 10x damage to 25m, 5x damage to 50m.

## PRESTIGE

Everyone wants to be a hero. When you are walking through the spaceport on your way home from a hard month's work, it feels good to have some young adolescent run up, asking for your autograph. It's nice when members of the opposite sex follow you around. Having groupies is cool. Well, all of this is a function of prestige.

The societies of the 23rd Century are big on heroics and the gossip of the day isn't soap operas, it's the battle on "what" planet against "whom." Characters build up prestige points for everything they do, good or bad.

Prestige has a direct effect on a PC's charisma score. A character's charisma increases by a ratio of 1 charisma point per ten prestige points. Thus, if you have accrued 30 points of prestige for heroic deeds, then your charisma increases by 3 points. This only applies when a character is traveling within the Core Worlds or is on an annexed planet. Furthermore, an individual's prestige score doubles within his home system. The table below lists the prestige awards for various deeds. Rewards are cumulative, and can be gained more than once for any action. Battle Masters may see fit to use this table or not as they choose.

DEED	POINTS
Save another's life while in the line of duty	0.2
Save the party's life while in the line of duty	0.4
Incredibly stupid act with great results	0.4
Save a city	1.2
Saves a planet	5.0
Saves the Alliance	15.0
Egregious act against another	1.0
Egregious act against the Alliance (small)	1.0
Egregious act against the Alliance (grand)	6.0
Survives an encounter with the Arachnids	3.0
Survive A Rift Run	4.0
Win on "The Survival Warrior"	1.0
Survive a Meeting with Jaquassarius Phentari	2.8
Battle Against the Rebels	2.0
Battle Against Pirates	1.5

DEED	POINTS
Galactic Ten Most Wanted List	5.0
Escape from New Leavenworth	1.5
Help Grandma across the street (wimp)	0.0
Steal a ship (small)	1.0
Steal a ship (humongous)	2.3
Make a "Big" discovery	1.0
Company Insignia	var
Bronze Crown	0.5
Galactic Achievement Medal	0.3
Purple Heart	0.2
Cross of Valiantry	2.0
Silver Star	4.0
Legion of Honor	6.0

\* Note: if the deed is not known or is done either covertly or anonymously no prestige can be gained, because no one knows you did it. (Sometimes this can be quite a relief).

LEVELS OF HEROISM	Prestige Points
Legend in Your Own Mind	2.0
Warrior	5.0
Battlelord	10.0
Hero	20.0
Mega Hero	30.0
Super Hero	40.0
Ultra Hero	50.0
Legend	80.0
A Force to Be Reckoned With	100.0

## RANK

Most Battlelords don't work directly for the government. They are typically employed by one of the 5000+ mega-corporations. Working for a specific corporation doesn't mean that they are only employed by that company either. Often, the rival companies hire out each others personnel to perform certain tasks that the particular company isn't setup to handle. If PCs work for the Space Systems Development Corporation as a mercenary, the company might loan them out to the Asteroid Mining Consortium to guard a mine site. Up until recently, there was a problem with rank structure, the difficulty being that any one company had its own para-military ranks, based on its own criteria. Problems arose in determining pay scale, based on time and grade. Worse yet, on those occasions where two companies fielded a unit composed of personnel from both corporations, there were always hassles in figuring out just who was in charge of who.

Finally, the Council passed into law the Workmanship Acts that set up an arbitrary unit of measure for determining rank. Now of course, one group refused to play ball and lost all government business subsidies and grants. The Eridani steadfastly refused to adhere to a rank structure that did not use the terminology that they preferred. Eridi-Corp, one of the Alliance's top 10 money making companies, lost some 10 trillion dollars in weapons research grants for its refusal to setup an arbitrary rank structure.

Only mercenary ground and naval units possess officer corps. Officers must possess two primary occupations and have a military leadership of no less than 65. Before an officer is eligible for promotion, he must have enough points in both his primary and secondary skills. Upper level officers are appointed to their post as well as some non-commissioned officers such as the Surgeon General.

In addition, only mercenary and naval types can command troops. The eligible rank for command is Corporal or Chief Petty Officer 3rd Class. Starting mercenary units almost never have soldiers who hold the credentials for the rank required to be in charge. In that event, the highest ranking person is given "Acting Jack" stripes, that is he is given the temporary rank of the grade necessary to lead, but not the pay. Acting Jack is a temporary status. A Corporal is given command before a Petty Officer is.

Given below are the para-military rank structures used by the various combat types, based on their primary field of endeavor. PCs



are promoted to higher levels when they attain a certain amount of experience in the field or when they perform so admirably that the situation warrants promotion. Black marks and accommodations figure heavily into whether or not a particular individual is promoted or demoted. The primary experience point value indicates how many points a character must have expended in his primary field to be promoted to the next rank. The Secondary Experience number denotes how much he must have expended in a secondary field, in addition to those requirements in his primary occupational field.

As Battle Master, you alone determine when a PC is promoted. Sometimes they have the points necessary for advancement, but the company doesn't have the slots open. Sometimes the company may waive the point schedule based on need or achievement.

### MERCENARY

RANK	PRIMARY	SECONDARY
Ensign	01-35	None
Private	36-40	None
Private 2nd Class	41-50	None
Private 1st Class	51-60	None
Corporal	61-70	None
Sergeant	71-90	10-25
Staff Sergeant	91-125	26-40
Sergeant 1st Class	126-170	41-70
Force Sergeant	171-240	71-100
Master Sergeant	241-300	101-120
1st Sergeant	241-300	121-200
Sergeant Major	301-400	201-300
Force Controller	401-500	301-400
Ground Controller	501-600+	401+

### MERCENARY OFFICER

RANK	PRIMARY	SECONDARY
2nd Lieutenant	25-45	None
1st Lieutenant	46-65	None
Captain	66-100	None
Major	101-150	None
Lieutenant Colonel	151-200	None
Colonel	251-300	10-25
Brigadier General	301-350	26-40
Lieutenant General	351-400	41-70
General	401-450	71-100
Sector Commander	451-500	101-120
Quadrant Commander	501-550	121-200
Forces Commander	551-600+	201-300
Lord	appoint	301+
Battlelord	appoint	appoint

### NAVY

RANK	PRIMARY	SECONDARY
Narc	01-35	None
Spaceman	36-40	None
Spaceman 2nd Class	41-50	None
Spaceman 1st Class	51-60	None
Petty Officer 3rd Class	61-70	None
Petty Officer 2nd Class	71-90	10-25
Petty Officer	91-125	26-40
Chief Petty Officer	126-170	41-70
Master Chief	171-240	71-100
Warrant Officer 1	241-300	101-120
Warrant Officer 2	241-300	121-200
Chief Warrant Officer	301-400	201-300
Force Controller	401-500	301-400
Space Controller	501-600+	401+

### NAVAL OFFICER

RANK	PRIMARY	SECONDARY
Officer Initiate	25-45	None
2nd Lieutenant	46-65	None
1st Lieutenant	66-100	None
Junior Commander	101-150	None
Commander	151-200	None
Captain	251-300	10-25
Rear Admiral	301-350	26-40
Vice Admiral	351-400	41-70
Admiral	401-450	71-100
Sector Commander	451-500	101-120
Quadrant Commander	501-550	121-200
Forces Commander	551-600+	201-300
Lord	appoint	301+
Battlelord	appoint	appoint

### SCIENCE

RANK	PRIMARY	SECONDARY
Tester	01-40	None
Tester 2nd Class	41-50	None
Primary Tester	51-65	None
Surveyor	66-80	None
Science Officer 3rd	81-100	None
Science Officer 2nd	101-120	10-25
Science Officer	121-145	26-40
Chief Science Officer	146-170	41-70
Field Leader	171-240	71-100
Science Specialist 1	241-300	101-120
Science Specialist 2	241-300	121-200
Chief Scientist	301-350	201-300
Master Scientist	351-400	301-400
Field Commander	401+	401+

### TECHNICAL

RANK	PRIMARY	SECONDARY
Operative	01-40	None
Operative 1st Grade	41-50	None
Operative 2nd Grade	51-65	None
Primary Operative	66-80	None
Specialist 5th Class	81-100	None
Specialist 6th Class	101-120	10-25
Specialist 7th Class	121-145	26-40
Chief Operative	146-170	41-70
Junior Commander	171-240	71-100
Senior Commander	241-300	101-120
Operations Commander	241-300	121-200
Systems Analyzer	301-400	201-300
Systems Master	401-500+	301+
Systems Controller	appointed	appointed

### MEDICAL

RANK	PRIMARY	SECONDARY
Intern	01-40	None
Medic 3rd Class	41-50	None
Medic 2nd Class	51-65	None
Medic Technician	66-80	None
Medical Specialist 1	81-100	None
Medical Specialist 2	101-120	10-25
Medical Specialist 3	121-145	26-40
Doctor	146-170	41-70
Zen	171-240	71-120
Surgeon	241-300	121-200
Chief of Surgery	301-400+	201+
Operations Commander	appointed	appointed
Surgeon General	appointed	appointed

## ESPIONAGE

RANK	PRIMARY	SECONDARY
Initiate	01-40	None
Spy 3rd Class	41-50	None
Spy 2nd Class	51-65	None
Spy	66-80	None
Infiltrator	81-100	None
Intelligence Officer 1	101-120	10-25
Intelligence Officer 2	121-145	26-40
Chief Intelligence Officer	146-170	41-70
Network Operative	171-240	71-100
Operative Senior Grade	241-300	101-120
Intelligence Analyzer	241-300	121-200
Commander	301-400+	201+
Operations Commander	appointed	appointed
Operations Controller	appointed	appointed

## OTHER

RANK	PRIMARY	SECONDARY
Worker 4th Grade (maggot)	01-40	None
Worker 3rd Grade (maggot)	41-50	None
Worker 2nd Grade (maggot)	51-65	None
Worker (super maggot)	66-80	None
Systems Operator	81-100	None
Functions Operator	101-120	10-25
Operations Chief	121-145	26-40
Sector Controller	146-170	41-70
Quadrant Controller	171-240	71-100
Company Controller	241-300	101+

## CALCULATING PROMOTION POINTS

Promotion points are calculated as follows: Take all skill levels, except those earned by defaults, in the field and multiply them by their point costs to determine how many skill points the character possesses in the field. Add one point for every point of Military Leadership above 95. Subtract 5 points per black mark. Add Promotion points from awards.

**NOTE!** Weapons and Gunnery skills count towards Military points, as does Hand to Hand skill. Security Systems skills count towards Espionage points, as does stealth skill. Physics skill counts towards Engineering points.

## SALARY VS GRADE

A character's salary is based on his primary occupation. A character with two primary occupations receives a 50% bonus on top of this, unless he is an officer, in which case his base salary is doubled. Additional primary occupations give a 25% bonus to all characters.

The first secondary occupation is worth a 25% bonus to the character's base salary; additional secondaries are worth 15%.

After the salary due to primary and secondary occupations is figured multiply this by a bonus of 1% per point of Military Leadership above 70. This is the character's base pay before promotions.

Each time a character is promoted, his salary increases by 7%. These are compound increases, i.e. multiply the characters base pay by 1.07 for each rank above the lowest.

## OFFICERS

In order to qualify as an officer a character must have two primary occupations and a Military Leadership score of at least 65.

Officers automatically earn an extra 04% increase in military leadership each time they are promoted. The highest ranking officer leads the group. Award them experience points based on how well they lead their troops. Assign them an efficiency rating from 1-25 and multiply the result by 50 at the end of every session.

## THE EFFECT OF BLACK MARKS ON PROMOTION

Black marks are real bad!! They can screw up your chance for a promotion in a big way. Officers who get black marks put their careers in extreme jeopardy. To many black marks and one can lose rank or worse yet, be sent to jail. The effect of black marks is given below.

Each black mark increases the points required to reach the next rank by 5 points. In effect, it requires that the PC gain an additional 5000 experience points before he gets promoted. If a player gets more than 3 black marks in a year, the amount of experience necessary to reach the next level is increased by 10 points (for each mark beyond 3). If you are a major screw up, 10 black marks in one year will get you thrown out of the company. If you are an Orion rogue, 20 or more black marks will land you in New Leavenworth Prison. Compile 25 or more and you may very well face the death penalty.

PCs don't think that it is fair that they can be thrown in jail when they aren't even in the military. Tell them that Larry says "Tough !@#\$". They signed a para-military contract and are bound to the laws of the company that hires them.

If you are looking to give out some black marks, here are some ideas.

THEIR ACTION AS A GRUNT	Black Marks
Per 250,000cr company loss (no intent)	1
Per 250,000cr company loss (neglect)	2-4
Per 250,000cr lost (intent)	3-6
Botched Mission (your fault)	1-3
Injure another party member (neglect)	1
Injure another party member (intent)	2
Maim another party member (no intent)	3
Maim another party member (neglect)	4
Maim another party member (intent)	5
Kills another party member (no intent)	3
Kills another party member (neglect)	5-10
Kills another party member (intent)	10-25
Convict escapes due to neglect	3-7
Convict escapes due to intent	7-20
Information lost due to neglect	3-10
Information lost due to intent	11-20
Act against company policies (minor)	1-3
Act against company policies (major)	4-10

**NOTE!!** Black Mark penalties for officers are multiplied by 1.5.

Black Marks allow you to control your PCs and stop them from killing each other. Now if the boss is lax, you might hand out less. But if the boss is strict, you might hand out more.

## MEDALS AND COMMENDATIONS

Everyone wants to be a hero. Everyone wants to stand tall and proud in front of a large group of people who applaud you when you are given a commendation for excellence. We all want to be judged by our peers and found to be worthy. We all want to be stars, stealing the lime light for awhile. Mercenaries in the future receive medals and commendations for actions above and beyond the norm. These medals have a direct affect on promotions and increase charisma of the person when he or she is in dress uniform. Below are just some of the commonly awarded medals. Cizerack don't believe in medals for they see all females in the same light.

**Occupational Ribbon:** Given to any individual with a primary occupation who has been in the service for more than 6 months. The ribbon is white with blue stripes on each end. The occupation symbol is centered on the ribbon and is silver. Equals 1 promotion point (1000 promotion experience) and increases charisma in uniform by 02 points.

**Fornax Shield of Courage:** Given to all persons who serve on hazardous duty in the Fornax galaxy. Bestowed by the Fornax government.



**Intrepid Silence Service Ribbon:** The quadrant sector chief of the And 3 galaxy awards this ribbon to all personnel who serve in a hazardous capacity in the And 3 galaxy. It is green with silver bands.

**The Silver Stars of Morokania:** Awarded by the King of Morokania to those daunted warriors who fought to put down the Civil war on his planet. Black with twin centered stars.

**Good Conduct Medal:** Red with thick bands on the ends. Awarded to all individuals who after two years of service, have no black marks on their records. Few Orions ever see one of these. Equals 3 promotion points and increases uniform charisma by 05 points. Additional ribbons are awarded in the form of a gold number centered in the middle of the award.

**Icon of the Controller:** The medal awarded to all matrix controllers who reach the 3rd energy bracket (proficiency). It is a small helix crystal hung from a button on a platinum chain of the controllers breast pocket. Promotion points: 3.

**Talisman of the Faithful:** Bestowed on all matrix controllers who reach the 5th energy bracket. It is a self radiating image of the controller himself, hung in the same fashion as the Icon of the Controller. Promotion points: 5.

**Infantryman's Combat Cord:** A braided yellow rope worn around the right shoulder. It is worn only by Alliance military personnel who are assigned to combat infantry units.

**Armor Combat Cord:** A braided white rope worn around the right shoulder. It is worn only by Alliance military personnel who are assigned to combat armor units.

**Frontier Accommodation Medal:** Given to all personnel who spend a combat tour (6 months) on the Frontier. This medal is a solid pale yellow. Promotion points 2. Charisma is increased by 04 points when in uniform.

**Galactic Achievement Medal:** Bestowed upon those personnel who perform actions above the norm for extended periods. The Galactic Achievement Medal is typically given for excellence in the person's occupation. Equals 5 promotion points and increases uniform charisma by 08 points. The GAM is red with gold trim.

**Military Honors Award:** Given to those military/para-military personnel who excel far above the norm under extreme stress (not battle). It is hot pink with gold trim. Promotion points: 3.

**Corporate Star:** A diamond ring with the initials of the corporation engraved on it. It is given to those personnel who serve faithfully for 20 years of duty. The design differs from company to company.

**Purple Heart:** Awarded to all personnel who are wounded in action (critical hit). It is a deep solid purple.

**Talisman of the Zen:** Bestowed upon all individuals who die in combat and are brought back to life. This medal is a solid off white ribbon.

**Necklace of the Covered Mind:** A small necklace, set with the face of the great Chatilian Highlord Makov Chatil. It is awarded to empaths who excel in the field of espionage.

**Cap of the Vigilant Watcher:** Jet black with gold leaf trim. This velvet cap is given to those personnel who combat pirate activities.

**Valkyrene Fighter:** A gold fighter centered on black ribbon. Given to those valiant warriors who flew the heralded flight of the Valkyries. Most were given posthumously, but 7 members of the vaunted Wolverine squadron are still alive.

**Robe of Sacrifice:** Bestowed upon Zen who show unswerving faith and honor. It is said that Assizza lived in abstinence, and that his robe grew more beautiful and radiant as he aged. The robe has silver bands and is valued at 100,000cr. The Robe of Sacrifice symbolizes the purest of the Zen faith.

**Sash of Xangar:** Awarded to those brave warriors who fought to put down the 1st Rebel Uprising. The sash is a deep crimson red, worn across the chest.

**Chain of the Fallen Warrior:** This gold sash is connected to the appellate and breast button of a soldier's uniform. Only those personnel who have spent 1 year in an Arachnid combat zone can be awarded the Chain of the Fallen Warrior. Promotion points: 5.

**Blood Star of Humas:** Distinction rendered to all personnel who survive a dreaded Rift Run. Mile Humas, a Gen-Human scientist, was the first known survivor to enter the Motaran Rift and escape with his life. The rest of his 20 member team perished in the void of the rift.

**Kismet:** A shimmering star sapphire set in a white gold signet ring. The ring stands as a signature of fate to all personnel who have survive 10 combat tours (1 year each). Promotion points: 5.

**Red Cross of Valiantry:** Any Alliance personnel subject who amasses 20 confirmed kills against the Arachnid ground forces and their minions is awarded the prestigious Red Cross of Valiantry. Promotion points: 4. Charisma increase in uniform is +06.

**The Black Cross of Simeron:** A large black cross worn around the neck. The cross is only awarded to the very few Arachnid POWs who manage to escape and live to tell of the horrors they were put through at the hand of the evil spider race.

**Temple of the Benevolence:** A huge blue diamond that is actually imbedded in the temporal lobe of the skull. It is awarded to the most courageous Zen combat medics. The diamond is valued at 500,000cr.

**Hammer of the Thunderbolt:** Awarded to all pilots who become aces flying against the Arachnid forces. It takes 7 kills to become an ace. The Hammer of thunderbolts medallion is a silver jagged thunderbolt, bisected by a hammer. It is worn on a chain around the neck.

**Tome of Knowledge:** The most powerful Chatilian empaths, usually from the 7th the energy bracket or higher, are given a solid gold book to exemplify their quest for knowledge. Estimated value: 2,900,000cr.

**Crest of Freedom:** The highest civilian award that anyone can receive. The Crest of Freedom is awarded to those non-military forces personnel who risk extreme peril in order to save the Alliance. The Crest of Freedom is a half moon centered on a blue ribbon.

**The Bronze Crown:** The third highest military and para-military accommodation that can be earned. Given for valor and heroism far beyond the call of duty. The crown is set in the center of a white ribbon. Promotion points: 4.

**The Crown of Assizza:** Grand Tour Assizza was the greatest known Zen Rigel'n healer to have ever lived. He championed peace and harmony, and discovered most of the Zen matrices of power. The Crown of Assizza is made of gold, with rubies and diamonds set into its face, in the visage of Assizza. It is awarded to the most prestigious and benevolent Zen master. It is valued at 750,000cr.

**Signet of Death:** A strange and mysterious item given to the most awesome and fearful of the Phentari people. The ring, a black onyx looks ordinary, but generates a deadly energy of some kind that drains the essence of the Phentari's enemy.

**Blood Kelp:** The Python Lizard equivalent to the Silver Star. It is a large white gold statue of a kelp branch. Estimated value: 3,200,000cr.

**The Peace Keeper's Urn:** The highest award that can be bestowed upon any Zen Rigel'n Healer. The Urn is heavy, 10kg cast in 24 carate gold with emerald in lay. Normally, a page (student) carries the chalice for the Zen and walks one step off the Healer's right shoulder to the rear. The chalice is valued at 1,000,000cr.

**The Scabbard of Eir:** Eir is the most legendary Eridani warrior that ever lived. History speaks of this mighty warrior who did battle against the most dangerous and wicked adversaries of the Eridani way of life. Eir once singlehandedly killed more than 100 Phentari armed with laser and other heavy weapons, with only a sword to save him. He disappeared on a quest to find and slay the legendary Black Dragon of Kanure. The greatest Buddon Priests are given this ceremonial scabbard to put their blade in. Valued at 1,200,000cr.

**Branch of Power:** The most coveted Ram Python item is the hypnotic Branch of Power. This 20kg solid gold tree branch sparkles with gems such as topaz, orange emerald, rubies, etc. Each year the greatest new Ram Python warrior is awarded the Branch of Power and becomes the honorary Fna (Tomud Highlord). Value 5,000,000cr.

**Silver Star:** This silver star represent the highest award that can be awarded for para-military forces. It is the more prestigious form of the Bronze Crown, with the person exposing himself to unreasonable danger in order to aid his comrades. Typically, one is awarded the Silver star for repeated acts of heroism. Promotion points: 6.

**Legion of Honor:** The highest award given. The Legion of Honor is given to those Alliance forces personnel who take the greatest risks to ensure the greatest gains. Most are awarded posthumously and the Ram Python race has the dubious distinction of having earned more of these than any other race. Promotion points: 10. Charisma increase in uniform +20.

## THE COMPANY UNIFORM

Most warriors are proud of what they do. Battlelords generally don't try to hide what they do for a living. Most wear their company colors boldly, so when they walk through the spaceport everyone will know just who the Hell they are!

Every company has their own company colors. Dress uniforms are skinsuits, typically displaying the company logo on the sleeve. Dress uniforms are usually worn whenever a unit is in and around a spaceport or in a highly visible post. Wearing the dress uniform is often mandatory, for it is direct advertising. When wearing the dress uniform, one must wear his medals and commendations.

The battlefield dress uniform is worn whenever a unit is entering a hostile environment. Battle fatigues still resemble those types of uniforms worn on the planet Earth in the latter part of the 20th Century. They are light weight and baggy, camouflaged to resemble the environment that the unit is entering. They still have a million and one pockets!

People don't live in battle armor! Very seldom does one spend more than a couple of hours a day suited up to do battle. Also it is virtually impossible to sleep comfortably in. So don't let them always have it on. Remember, most places have ordinances prohibiting weirdos from wandering around in suits, packing heavy weapons! Locals are so unreasonable.

Finally, companies authorize plain dress whenever they want personnel to remain low key and unobtrusive. Otherwise they keep their own in appropriate attire.

## CONTACTS

The universe in absolutely huge. There are thousands and thousands of planets sprinkled across hundreds of millions of light years. Adventuring mercenaries will travel more in one week, than most Alliance subjects do in their entire lifetime. Always expect the unexpected. Characters are going to run into unexpected problems that may cost them their lives, if they can't overcome them. They may lose fortunes because they aren't able to obtain some item that they desperately need. The answer to the problem is contacts. Characters can develop powerful contact networks that can provided vital assistance in times of need. If the character gets into trouble, he can seek assistance from the Network.

**Example:** Henry the Mutzachan's Infiltrator class star cruiser Uranium Sun has broken down in orbit above the remote ore/refueling platform Malsis 19. He desperately needs a microchip to fix the drive engines and Orion pirates are hot on his tail. Without the Network that Henry has setup in this area of the Galaxy, he would be in a universe of trouble. But Henry was smart and foresaw such a problem. He calls in his secret identification code to the Network center and the part is picked up and delivered immediately, saving Henry's 150,000,000cr ship and probably his life.

The methods of obtaining, maintaining, and expanding Networks is given below. They are a vital part of the Battelords of the 23rd Century roleplaying game and should be carefully considered by player characters.

## STARTING CONTACTS

All player characters start the game with a certain number of Network contacts as prescribed by race type, social status, and charisma scores. These contacts are either in the Inner Circle (Core Worlds), the Andromeda Galaxy, Greater Magellanic Clouds, or on the Frontier. Each Network functions in specific sector of a given quadrant of a galaxy. The Network is assumed to function throughout that entire area and can lend assistance as long as the character is within the Network's zone of control. The starting contact numbers are specified in the tables below.

### STARTING CONTACTS

RACE	#	RACE	#
Chatilian	6	Mutzachan	10
Cizerack	5	Orion Rogue	12
Eridani	8	Phentari	8
Gen-Human	15	Python Lizard	2
Human	13	Ram Python	2
Mazian	2	Zen Rigel'n	7

## CHARISMA MODIFIERS

Subtract or add the appropriate number of contacts from the starting total.

Score	Mod	Score	Mod
-30 to 00	-3	51 to 75	0
00 to 25	-2	76 to 100	+1
26 to 50	-1	101 to 125	+2

## SOCIAL STATUS MODIFIERS

Subtract or add the listed number of contacts from the starting total.

SOCIAL CLASS	#	SOCIAL CLASS	#
Poverty	-2	Wealthy	+2
Lower Class	-1	Rich	+3
Middle Class	0	Loaded	+4
Content	+1		

## DISTRIBUTION OF NETWORK CONTACTS

A character's contacts are spread out over a large area. To determine where the contact is, simply roll on the following table to determine general locale. There are 4 quadrants in a galaxy. Each quadrant has 8 sectors. So each galaxy has a total of 32 sectors. To determine which quadrant the contact is located in, roll a d4. To determine which sector the contact is in roll a d8.

GALAXY	DICE
Milky Way	01-40
Andromeda	41-60
Greater Magellanic Clouds	61-67
Lesser Magellanic Clouds	68-72
Spirax (M33)	73-77
Cluster (NGC-185)	78-80
Leo 1	81-83
Leo 2	84-85
Sculptor	86-87
Carina	88-89
And 1	90
And 2	91
And 3	92
Ursa Minor	93
Corona (NGC-205)	94
Naxtar (M31)	95
NGC-147	96
Fornax	97
Hospis (M32)	98
IC-1613	99
Frontier	100

NOTE!! If a dice roll of 100 is made, roll on the Frontier Table below.

All the above galaxies are within 50,000 light years of the Milky Way galaxy. They are all real galaxies and their game locations correspond to their actual position in respect to our own galaxy. These 20 galaxies constitute what is called our Local Group. Our Local Group represents but a tiny fraction of the entire universe. The local group is merely one of a group of galaxy clusters. There are billions of galaxies, each with billions of stars!

## FRONTIER NETWORKS

There are very few established networks on the frontier. That is probably due to the fact that there are very few colonized worlds, let alone established planets. Consequently, each frontier network is assumed to control the entire region. There are no quadrants or sectors on the frontier.

REGION	Dice
Ursa Major	01-40
M81	41-60
Outbound (M101)	61-70
Windfall (NGC 1823)	71-80
Sirion (NGC-2207)	81-90
Novon (NGC 2841)	91-95
M66	96-100

## GOVERNMENT NETWORKS

There exist special government networks designed so that PCs can get a little "pull" when they need it. Government networks hold strong political influence in all areas of the Alliance. PCs may wish to obtain special dispensations to carry a Bounty Hunter license, secure a weapon permit, open trade routes, etc. They must obtain government permission in order to do this, and a government network is the best way to facilitate operations.

If a PC begins the game with high contacts in the government from the fate tables, then he automatically starts the game with 2-8 government network contacts, each one with a strength between 2 and 5. Furthermore, he need not pay the additional (200%) cost to increase or maintain a government network contact. Government networks cost twice as much to maintain or increase as a normal network.

## LEGAL NETWORKS

PCs are going to get BUSTED! And you will enjoy sending them to jail. But we all know that they need a way out.

Make 'em pay through the nose for it. Legal networks are a way to get your hand (or tentacle or whatever) in the judges pocket. The money that you pay helps to "persuade" him to give the "correct" decision. Why should he care if they go to jail?

The strength of a legal network is the percent chance of modifying the judgement in whatever direction you wish. Comes in handy if a corpse happens to be found. Problem: Make the PCs pay 3x the normal amount to maintain and increase a legal network. If you have already incarcerated them, they must pay 5x cost to START a legal network. If you are in a bad mood, or they have been REALLY stupid, make them pay 10x. After all, you have them by the &#@\$%.

## VALUE OF THE NETWORK

Networks have an assigned starting value ranging from 1-6. This number indicates the relative strength of the entity with 6 being the highest possible starting strength. The number multiplied by a factor of ten indicates the percentage chance that the Network will be able to assist a character. Thus a network with a strength value of 6 would have a 60% base chance to assist someone.

The network will attempt to aid someone in any way that they can. They will pick up spare parts, run interference to allow a ship to escape, produce false ID, etc. They don't do it for free! They charge for the goods when they are delivered or the task completed. Networks provide assistance, not free materials, unless of course it is something petty. Another point of mention: A network isn't going to do your laundry for you and you can only call on it twice a month for assistance.

If you fail to pay a charge, the network is nice enough to let you off the hook for a while. You have one month from the date of charge to pay off your debt with a 100% cost penalty applied or you will be "excommunicated" from the network. Persons who are excommunicated are black listed on all networks. Furthermore, a bounty hunter will probably be paying that person a visit.

## MAINTAINING A NETWORK

Networks have to be maintained or they are lost. One must pay the value of the network multiplied by 100 every six months. If you fail to pay on time, There is a 100% penalty accrued for every month that you are late making payments. Overdue accounts can not be used and are temporarily closed. Typically, characters set up an allotment which automatically pays for the network maintenance.

## INCREASING NETWORK STRENGTH

At times, characters may wish to permanently increase the strength of a particular network. To accomplish this, they must spend 50,000cr per point of strength increase. There is a 75% chance that the network will be able to obtain the resources necessary to meet the person's demand. If it is unable to increase its power, the money is lost.

## PRIMING A NETWORK

You can prime a network by paying large sums of money in advance. Priming a network temporarily increases the entity's strength. Each 5000cr spent increases the value of the network by 1 point for 1 month. There is a 90% chance that priming a network will work. Failure indicates that the money is lost and the contact strength remains the same. (There is a greater chance to prime a network temporarily because the entity may be able to get its hand on resources temporarily.)

## ESTABLISHING NEW CONTACTS

Personnel may seek out new contacts to expand their network. This is difficult and time consuming. First, the character must effectively spend all of his free time searching out a contact. There is a 03% cumulative chance per week of finding a contact. It cost 200-800cr per week to find a contact. All new contacts are assumed to be strength level 1-4. Yes it may cost you thousands of credits to find a new contact!! You didn't actually think it was going to be easy did you?

## IONIC STORMS VS MAKING CONTACT

Ionic storms and solar flares and completely block communications during a Contact Phase or Action Phase. The Contact phase occurs when the person is actually calling up communication relay stations to make contact. If there is any ionic storm, hyperionic radiation, or solar flares anywhere between the initiation point and the contact point, then there is a chance that contact may not be possible. The strength of the disturbance is given a rating from 10-100. This number is subtracted from 100. The result is the percentage chance that the PC can get through.

Ionic disturbances during the Action phase can be catastrophic! After the Contact Phases is successful, the network will try to complete its part of providing assistance during the Action Phase. Often the Network must carry out the assistance in steps, doing one thing first, then getting back in contact with the PC to proceed to the next step. This allows you to mess with PCs just for the fun of it. You can LEGALLY prevent them from carrying out a mission. Ionic storms during this phase may prevent the two parties from communicating, thus interrupting the assistance. In the event of a disruption in communication during the Action Phase, the network will attempt to follow a logical train of steps to rectify the problem, such as proceeding to the most likely rendezvous spot. At no time during an interrupted Action Phase will the network put its personnel at risk. If they can not provide the assistance, the person who initiated the contact must still pay the fee for services rendered.

## THE CLAMP DOWN

The Alliance has gotten together with independent planet nations to stop the networks. Recently, the representatives from more than 1000 planets signed the Intergalactic Interdiction Treaty which provided plans to stop network practices. All nations would randomly run line checks on intergalactic phone calls. (By the way there aren't any telephone lines connecting galaxies. It is just a term that they use).

Special anti-network task forces would be fielded to stop the Contact phase with government officials masquerading as potential network contacts in order to prevent people from making contact in the first place. Individuals caught trying to make contact face stiff prison

terms, ranging from 1-10 years in prison. All members of the Intergalactic Interdiction treaty also agree to field ships to stop the Action Phase from being carried out.

## NETWORK TIES TO THE BLACK MARKET

Networks have extensive ties with the Black Market and many black market items can be purchased through a network. The relative strength of the network is reduced by 2 points if someone is trying to purchase something on the Black Market. The cost of purchasing goods through the Black Market and the network is very high. The network would rather not be involved with this type of trade, so it charges an additional 100% of the Black Market price so that the person would end up spending 200% of the Black Market price.

## MAIL SERVICE

Mail service is just as important if not more than it was on Earth in the late 20th Century. It costs about the same to mail items on planet. But the cost of mailing a parcel from planet to planet, star to star, or even, galaxy to galaxy can be expensive indeed. The mail is transported on warships, usually light cruisers with modified defense and weapons systems. A planet to planet parcel weighing 28 grams costs 1-6cr to deliver and takes 1-3 days.

Interstellar mail service takes anywhere from 3-7 days and costs anywhere from 10-40cr. Intergalactic mail service takes 1-4 weeks and costs 40-240cr just to deliver a letter!!! Interstellar and Intergalactic mail is heavily guarded. Normally a heavy cruiser with a convoy of police cruiser escorts accompany the "postman."

Galactic Express boasts that it can get a letter anywhere in Civilization in less than 2 days. False advertisement! The operative word here is Civilization!!!

## THE MASNROCK GENERATOR

The moon Masnrock is located at the heart of the Alliance, orbiting New Terra. The lifeless rock has been converted into the largest wormhole generator in all the known galaxies. The generator complex is 200km long, 50km wide, and 20km deep. The Masnrock Generator can generate a wormhole powerful enough to reach the farthest Alliance outpost. Any object can be transported to another place, as long as the coordinates are known. The Alliance charges anywhere from 5000-50,000,000cr to instantaneously transport a parcel.

## THE PHONE BILL FROM HELL

All that we will say on the subject, is look at the cost per call, per minute. Oh by the way, intergalactic communication is managed by punching a worm hole through space/time and then stabilizing it and holding it open.

The cost for intra-planetary phone service is comparable to that on the planet Earth during the latter part of the 20th Century.

RANGE	COST PER MIN
Interplanetary	100
Interstellar	1000
Intergalactic	2500

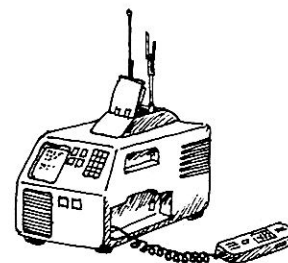

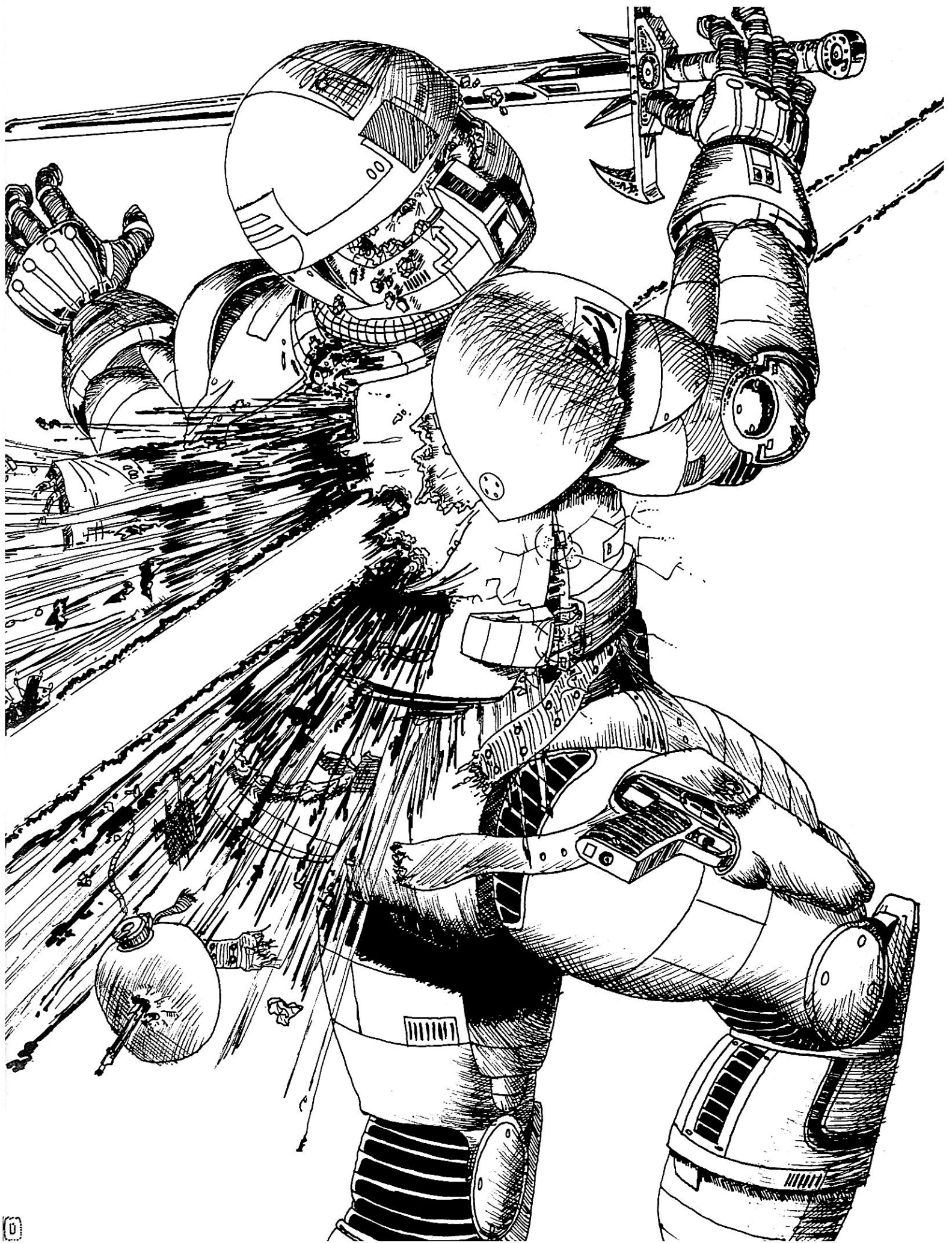



## AVAILABILITY OF ITEMS

The availability of items for Battlelords of the 23rd Century is a big issue to any Battle Master. Players are always arguing that the equipment that they need should be readily available on the open market. But what is actually available depends entirely on the Tech Level of the planet and how prolific the manufacturing of the item is on that planet. Thus all items are assigned a Tech Level (TL) and an Availability Rating (AV).

**TL:** The item is manufactured on a planet with this Tech Level. If PCs look for an item on a planet where the Tech Level is not within these limits, then the chance of finding this item is decreased by 15% per difference in TL.

**AV:** This denotes the base chance of finding the item within the appropriate tech level.

P: Prolific	95%	R: Rare	20%
VC: Very Common	75%	VR: Very Rare	05%
C: Common	65%	U: Unique	01%
UC: Uncommon	40%		

**Example:** Fredd the Python is looking for BRI's. He is on a TL 1 Planet. The base chance to find BRI's is equal to Availability - (TL discrepancy x 15). The chance to find it equals 95(P) - 45 (3x15) = 50%.

**Note!!!** Each level of Street Smarts increases the chance of finding an item by 03%.

## EMERGENCY MEDICAL GEAR

ITEM	TL	AV	COST
Biological Redox	3-5	R	30
Blood Transfusion	2-5	P	40
Body Cart	5-6	VR	30,000
BRI (std)	4-6	P	100
BRI (massive)	4-6	C	500
Chemical Redox	3-6	R	300
Coolant Injection	5-6	R	225
Cryo Injection	5-6	VR	10,000
DNA-6BMR	5-6	VR	1000
First Aid Kit	2-4	P	20
Isolation Bag	4-6	R	1000
Paramedic Kit	3-6	C	15,000
Perception Injection	4-5	R	300
Methane Injection	4-6	R	500
Radiation Treatment	3-6	R	600
Rage Injection	4-6	R	500
Reflex Tablet	3-5	R	700
Regeneration Serum	5-6	VR	50,000
Storage (medical)	3-6	VC	5000
Surgical Kit	3-6	UC	5000
Truth Serum	3-5	R	5000
White Count Injection	3-5	UC	150

## ENVIRONMENTAL HAZARD GEAR

ITEM	TL	AV	COST
Chemical Alarm	2-5	VC	125
Chem Goggles	3-5	UC	200
CS-4 Chemical Suit	3-5	UC	325
CS-7 Chemical Suit	4-6	R	600
Decon Kit	2-5	P	500
E-Tent	6	VR	25,000
Filter Mask	2-5	P	100
Geiger Counter	2-5	P	400
Gloves (protective)	2-6	P	2
GM-4 Gas Mask	3-5	UC	250
GM-7 Gas Mask	3-5	UC	425
Hot Bath	5-6	VR	15,000
Identification Tape	2-5	UC	15

## PERSONAL EQUIPMENT

ITEM	TL	AV	COST
Atmospheric Processor	4-6	R	5000
Backpack	2-4	P	40
Body Computer	4-6	R	12,500
Brain Scratcher	4-6	R	30
Case (water proof)	2-6	VC	30
Case (super)	4-6	R	250
Case (shock proof)	3-4	UC	75
Case (magnetic proof)	3-6	R	120
Chem Lab (portable)	3-6	UC	700
Compass	2-3	P	7
Compass (magnetic)	2-5	P	15
Digital Compass	3-6	C	100
Dummy (practice)			ANY TECH LEVEL YOU LIKE 500
Emergency Transmitter	3-5	UC	100
Flare Gun	2-4	P	75
Flashlight (threader)	3-4	UC	12
Flashlight (normal)	2-3	P	5
Grapple Gun	2-5	VC	75
Grapple Hook	2-5	VC	15
Fire Extinguisher	3-6	P	20
Grenade Scoop	5-6	R	25,000
Holo Generator (v)	6	VR	45.2M
IFN	4-5	UC	300
Mega Glue	4-6	UC	20
P-Cabin	6	VR	5000
Parachute (prof.)	3-4	VC	1500
Parachute (military)	2-3	P	900
Phent Morsels			DEPENDS ON AVAILABILITY 25
Pitons (20)	2-5	P	25
Plasma Generator	4-6	R	250,000
Pneumatic Saw	3-5	UC	170
Polymizer (heavy)	5-6	R	250,000
Polymizer (portable)	5-6	R	100,000
Pur. Tablets (food)	2-4	P	10
Pur. Tablets (water)	2-4	P	8
Raft: 2 man	2-4	P	100
Raft: 4 man	2-4	C	225
Raft: 6 man	2-4	UC	400
Range Finder	3-5	UC	8000
Refrigerator	3-4	UC	125
Repellant (bug)	2-6	P	10
Rope (std): 20m	1-6	P	10
Rope (flex): 20m	3-6	UC	50
Satchel	1-5	P	10
SCUBA Equipment	2-4	C	350
Shark	4-6	R	4000
Sleeping Bag	2-5	P	80
Sleeping Bag (arctic)	2-5	C	140
Sleeping Bag (Methane)	4-6	R	500
Still	3-5	R	900
Stove	3-5	VC	100
Tablets (salt)	2-5	P	3
Tablets (protein)	2-5	P	50
Tent: 2 man	2-4	P	110
Tent: 4 man	2-4	VC	225
Tent: 8 man	2-4	UC	350
Thwack'em Stick	3-5	R	500
Tool Kit (normal)	2-4	VC	100
Tool Kit (masters)	3-4	UC	500
Tool Kit (ion)	4-6	R	50,000
Tool Kit (elect.)	4-6	UC	15,000
Web Gear	2-6	P	40

## ESPIONAGE EQUIPMENT

ITEM	TL	AV	COST
Acidizer	4-6	R	700
Blow Torch	2-4	VC	35
Camera 35mm	2-4	P	150
28mm lens	2-4	P	90
135mm lens	2-4	P	115
70-220mm lens	3-4	P	120
110-440mm lens	3-4	P	200
Cam Flybot	5-6	VR	25,000
Contact Microphone	3-5	R	75
Electronic Tracer	3-5	R	250
EV-1 mole	5-6	VR	20,000
Infrared Dampener	4-6	R	10,000
Jump Pads	4-6	R	10,000
Lock Picks (basic)	2-3	UC	200
Lock Picks (prof.)	3-4	R	600
Lock Picks (elect.)	3-5	R	2000
Mini Camera	3-5	R	1000
Mini Scanner	3-5	R	1200
Mini Video Camera	4-6	VR	3500
Pocket Signal Detector	4-6	VR	200
Pry Bar	2-4	P	10
Wire Cutters (prof.)	2-4	C	80
Wireless Mini Cam	4-6	VR	7000
Wrist Torch	3-4	R	200
X-ray Camera	5-6	VR	15,000
X-Ray Video Camera	5-6	VR	25,000

## DETECTION EQUIPMENT

ITEM	TL	AV	COST
Binoculars (long)	2-4	C	50
Binoculars (wide)	3-4	UC	50
Binoculars (infrared)	3-5	R	1000
Binoculars (night)	4-6	R	5000
Binoculars	2-4	P	25
Bio Scanner	4-6	R	7,000
Bug Finder	3-4	UC	500
Bug Killer	3-4	UC	1500
DD-48 Vaporizer	3-5	R	1000
D3-A Scanner	3-5	VR	25,000
Goggles (IR)	3-5	R	150
Goggles (UV)	3-5	R	100
Infrared Spotlight	3-6	R	500
Jam Detector	3-6	R	1000
Mood Discriminator	4-5	R	3,000
Motion Detector	3-6	R	10,000
Metal Detector	2-5	P	200
Plastic Ex. Detect.	3-5	UC	2500
Radar Detector	3-5	UC	5000
Sonic Amplifier	3-5	R	1000
Sonic Discriminator	4-6	R	4000
Transmission Jammer	4-6	R	10,000
UV Flare	4-6	R	1500
Vibro Rod	4-6	R	7000

## COMMUNICATIONS EQUIPMENT

ITEM	TL	AV	COST
Ear Transceiver	3-5	R	150
Radio (hand)	2-4	P	70
Radio (traveler)	3-4	VC	150
Radio (field)	3-4	UC	500
Radio (base)	3-5	UC	1200
Radio (long range)	3-5	R	4000
Radio (interplanetary)	4-6	VR	40,000
Radio (interstellar)	5-6	VR	4.5M
Shoe Phone	3-5	R	400
Watch Phone	3-5	R	500

## ARMOR TABLE

TYPE	TL	AV	COST
Banded	1	UC	120
Chain	1	UC	100
Leather	1	P	70
Plate	1	VR	150
BP-1	2-3	P	100
BP-2	3	UC	150
Street 1	3-5	R	3000
AKM	3	P	450
Cub	3-4	VC	2500
Street 2	3-5	R	15,000
AKMB	3-4	VC	1400
Welch	3	R	3500
Reflection	4-6	R	10,000
Guisarme	3-4	R	20,000
Bear	4-6	VC	12,000
Flex	4	P	8000
Street 3	4-6	VR	40,000
BSH	4-5	R	14,000
D2	4-6	C	30,000
Kodiak	4-6	UC	50,000
Streetwise	4-6	VR	90,000
CD 2	5-6	R	92,500
Gladiator	5-6	R	200,000
MX 4	5-6	R	145,000
Repulsor	5-6	VR	150,000
Mesh	5-6	UC	160,000
Tri-Mesh	5-6	R	290,000
Assault	6	R	0.5M
Heavy Assault	6	VR	1.0M
MBA	6+	VR	2.0M
Argus	6+	VR	4.0M
Dreadnought	7	U	20.0M
T-12	3-5	R	10,000
EVM 1	3-5	C	1500
BES	4-6	VR	20,000
ES-3	4-6	R	3000

## HELMETS

TYPE	TL	AV	COST
Kevlar 3	3	P	150
Tri-lar	3	C	300
AKMH	3	UC	950
DH-1	3-4	P	3000
Shalkon	4-5	R	8000
DH-2	4-6	VC	18,000
Dancerz	4-6	R	25,000
Deshard	5-6	R	40,000
Tri Mesh	6	VR	120,000
MBA	6+	VR	250,000
Bell SS	4-6	R	54,000
AKMS	4-6	R	56,500
Deshard S	5-6	VR	85,000
Rangemaster	4-5	UC	18,000
Shalkon MS	4-6	R	100,000
Jousen 3	4-6	R	150,000
Deshard X	5-6	VR	200,000
Goliath	6+	VR	0.5M
Defender	7	U	0.75M
TDA	3-5	R	335,000
TDA-2	4-5	R	0.5M

**MARS SYSTEMS**

TYPE	TL	AV	COST
Guardian	6+	U	3.0M
Warrior	6+	U	7.0M
Hercules	7	U	10.0M
Titan	7	U	32.0M

**TIES**

TYPE	TL	AV	COST
Masrock	5-6	VR	5.0M
Argonite 1200	5-6	VR	3.8M
Sprinkler	4-6	VR	0.5M
Shadowfax	5-6	VR	2.0M
Shadow Master	6	VR	2.2M
Son of Sam	5-6	VR	10.0M

**HIGH TECH ARMOR OPTIONS**

TYPE	TL	AV	COST
Ablative liner	4-6	R	250
AMM	4-6	R	25,000
Anti-Plas Generator	5-6	VR	75,000
Anti-Grav Belt	4-6	R	75,000
Anti-Magnetic Gen.	4-5	R	25,000
Arm Rocket	4-5	C	1000
Auto Injector	4-6	P	3500
BMH (basic)	4-6	R	1500
BMH (look and shoot)	4-6	VR	35,000
Body Flares	4-6	R	10,000
Camouflage Unit	4-5	UC	3500
Carrying Case	3-6	P	10,000
Corrosive Protection	3-6	VC	1000
Cryo Option	5-6	R	25,000
Displacement Device	5-6	VR	75,000
Drop Bag	4-6	UC	5000
ECM	4-6	R	1000
EM Converter	4-6	R	25,000
Environmental Contain.	4-6	P	1400
Flotation Device	3-5	UC	2000
Flux Shield	5-6	VR	150,000
Gills	3-4	R	2500
Grappling Hoist	3-4	UC	1500
Grenade Launcher	3-5	C	5000
Gyro Stabilizers	5-6	VR	2000
Heavy Belt	5-6	R	125,000
Heavy Missile	5-6	R	200,000
Holographic Generator	6+	VR	250,000
Hover Jets	4-6	R	60,000
Infrared Dampener	4-6	UC	4500
Infrared Discrim.	4-6	R	15,000
Insulation (EMP)	4-6	R	20,000
Int. Food Processor	4-5	C	1000
Jet Pack	3-5	UC	35,000
Jump Pads	4-5	R	10,000
Kinetic Energy shield	4-6	UC	20,000
Laser Shield	4-6	R	35,000
Magnetic Disrupter	4-6	R	75,000
Mag. Deflection	4-6	R	30,000
Missile Rack	4-6	UC	30,000
Mrs. Fusion	4-6	R	80,000
Oxygen Supply	3-6	C	750
Power Rack	4-6	R	34,000
Prot. (absorption)	3-6	P	150
Prot. (hydraulics)	4-6	VC	10% armor cost
Prot. (servos)	4-6	VC	10% armor cost
Prot. (plating)	4-6	VC	250/Space
QSU	4-6	P	2000
Rad-Liner	3-6	P	250
Radar	3-5	UC	60,000
Reflex Missile	4-6	UC	10,000

TYPE	TL	AV	COST
Scatter Laser Def.	5-6	VR	40,000
Search Light	3-5	P	500
Shield	1	P	var
Skalers	3-4	UC	2000
Smoke Generator	3-5	UC	3250
Suicide Bomb	4-6	VR	40,000
Talons	3-5	VC	5000
Thermal Generator	4-6	R	30,000
UV Scrambler	4-6	R	15,000

**ARCHAIC HAND HELD WEAPONS**

TYPE	TL	AV	COST
Axe (hand)	1-2	P	10
Axe (throwing)	2-3	UC	24
Bow (short)	1-3	P	25
Bow (long)	1-3	UC	70
Bow (compound)	2-3	R	150
Catir	3-4	R	270
Club	any	P	0.7
Crossbow (light)	1-3	R	55
Crossbow (heavy)	1-3	VR	110
Dagger	1-6	P	4
Dagger (thrown)	1-6	P	15
Doka	1	P	12
Dossien	5-6	R	10
Flail	1	P	20
Ioken	4-6	P	85
Muadirg	4-6	VC	700
Ptfaang	4-6	P	70
Quabal	4-6	UC	350
Skil	4-6	R	200
Spear	1	P	3
Sword (broad)	1	P	30
Sword (short)	1	P	40
Sword (long)	1	UC	56
Two Handed Sword	1	VR	80
Toma	4-6	R	500
Tieaz	4-6	VR	60

**PISTOLS**

TYPE	TL	AV	COST
S&W .22 Cal.	2-3	P	40
Derringer .44	2-3	R	220
Police .38 Cal	2-3	P	100
Colt .357 mag	2-3	UC	130
S&W .44 Cal.	2-3	R	245
Colt Anaconda .48	3-4	R	425
Walther PPK	2-3	R	560
Beretta 9mm	2-3	R	675
IMI Eagle	3	R	800

**SUBMACHINE GUNS**

TYPE	TL	AV	COST
Thompson	2	UC	375
IMI Uzi	2-3	VC	350
MP5	3	UC	600

**RIFLES**

TYPE	TL	AV	COST
Galil A.R.	3	VC	300
FN-FAL	3	UC	1850
Barrett 82	3	R	15,000
TK-7A	3-4	VR	10,000
M-16A3	3	P	500
AK-57	3	P	450

**MACHINE GUNS**

TYPE	TL	AV	COST
M-60	3	P	3500
PK	2-3	P	5000
XM214	3	R	10,000
LTX311	3-4	R	15,000

**SHOTGUNS**

TYPE	TL	AV	COST
Ithaca	2-3	P	150
Remington 870	3	UC	200
Winchester	3	R	550
Franchi	3	R	375
Pancor	3-4	VR	7000

**LASER PISTOLS**

TYPE	TL	AV	COST
Mirchaum SS-L	3	UC	200
OLC-Pistol	3	VC	400
PL-3	3-4	C	575
BS-2	3-4	UC	800
Savage-B	4-6	R	12,225
MC-6	3	VC	2200

**RIFLES AND CARBINES**

TYPE	TL	AV	COST
M16-L	3-4	VC	5000
M18-L	3-5	P	5570
Tagert 6	4-5	R	25,000
RKM	4-6	R	18,500
Micron	4-5	R	25,000
Alpha 2	4-6	P	50,000
Beta 3	5-6	UC	80,000
Gamma 4	5-6	VR	250,000
Shalkon	5-6	UC	40,000
Backshaw	5-6	R	20,000
Falcon XR-7	4-6	VR	200,000
Toshoni LLC	4-6	VR	20,000
Calsham-4	5-6	R	500,000
Arrow LSON	4-6	UC	25,000

**MACHINE GUN LASERS**

TYPE	TL	AV	COST
Valley Green	5-6	UC	4.5M
Shalkon Heavy	6	VR	6.5M

**IMPACT LASERS**

TYPE	TL	AV	COST
Lancer	7	VR	0.75M
Crusader	7	VR	1.5M
Excellcior	7	VR	2.0M

**PULSE WEAPONS**

TYPE	TL	AV	COST
PC-3	4	P	16,500
PC-6	4-5	VC	18,000
M-20 Blaster	4-5	C	20,000
RP-4 Masher	5	R	50,000
Mentar	4-5	C	25,000
BC-Engager	6	C	100,000
BC-Enforcer	5-6	UC	200,000
BC-Destroyer	6	R	0.5M
BC-Terminator	7	U	1.0M
Vector 1	4	VC	80,000
Vector 3	4-5	C	150,000
Vector 4	5-7	VC	200,000

TYPE	TL	AV	COST
Mentar-A3L	5	VR	250,000
M-80	6-7	VR	3.8M

**OMEGA WEAPONS**

TYPE	TL	AV	COST
OP-1	5	UC	35,000
Balshrom FC	5-6	R	42,000
OX	5-6	R	55,000
LS-21	4-6	C	120,000
Able 3	4-6	VC	100,000
Able Ram	4-5	R	250,000
Viper XM1	5-6	VR	275,000
Cobra XM2	6	VR	325,000
Balshrom 2	5-6	VR	300,000
Python XM3	6-7	VR	1.0M
Devastator	7+	U	2.0M

**PARTICLE BEAM**

TYPE	TL	AV	COST
AM1	5-6	UC	10,000
Cheetah	5-6	R	25,000
Tiger	5-6	R	60,000
Lion	5-6	VR	160,000
Mark 3	5-6	U	127,000

**DISRUPTORS**

TYPE	TL	AV	COST
Neutralizer	5	R	25,000
K-4	5-6	R	45,000
Majestic	5-6	R	60,000
Majestic 2	5-6	R	70,000

**DISINTEGRATORS**

TYPE	TL	AV	COST
Duster	5	R	125,000
Gashil	5-6	R	110,000
Americas	6	VR	.5M
Comrade	6	VR	.5M
Rommel	6-7	U	2.5M

**MESON CANONS**

TYPE	TL	AV	COST
Accelerator	5-6	C	22,500
Emissions	5-6	UC	25,000
Henderson	5-6	UC	32,500
Quasar	5-6	VR	320,000
Pulsar	5-6	R	350,000

**METAL GUNS**

TYPE	TL	AV	COST
BC Render	4-6	C	20,000
BC Shredder	4-6	UC	40,000
TR-9B	4-5	R	95,000
Parabellum	4-6	VR	200,000
Calsham MG	6	U	1.5M

### MAG GUNS

TYPE	TL	AV	COST
Stickgun	4-6	UC	30,000
Metal Man	4-6	UC	55,000
Deliverance	4-6	VR	49,000
Magnatron	4-6	R	70,000
Carousel	4-6	U	100,000

### PERSONAL MISSILE SYSTEMS

TYPE	TL	AV	COST
Pershing 2	4-6	UC	50,000
Minuteman	5-6	UC	75,000
Ballistics-8	5-6	R	32,000
GTL	6	VR	95,000

### SPECIALIZED WEAPONRY

Type	TL	AV	COST
Sonic Disrupter	3	R	9000
Taser	3	UC	1000
Energy Mace	5-6	VR	50,000
Light Sword	5-6	VR	60,000

### GRENADE LAUNCHERS

Type	TL	AV	COST
M-L50	4-6	R	5000
M-203	2-3	VC	400
M-75	3-5	R	3500
Turbo Plus	3-4	VR	50,000

### FLAMETHROWERS

TYPE	TL	AV	COST
A-2	4	C	500
ME2E1-9	3	VC	2500
ME2E1-9B	3	C	4000
Blazer	4	R	7000

### ROCKET LAUNCHERS

TYPE	TL	AV	COST
Belair	3-4	UC	10,000
Zandovich	3-4	R	50,000
Steiger 3	3-4	R	40,000

### ANTI-TANK WEAPONS

TYPE	TL	AV	COST
Bazooka	2	C	9000
Panzerfaust	2	C	5000
LAW	2-3	C	1500
RPG-7	3	U	5700
Dragon	3-4	R	35,000
TOW	3-4	R	60,000
Figlini	4-5	R	80,000
PLG	4-5	R	165,000
Bonoir	6	VR	250,000
HAW-4	6	R	300,000

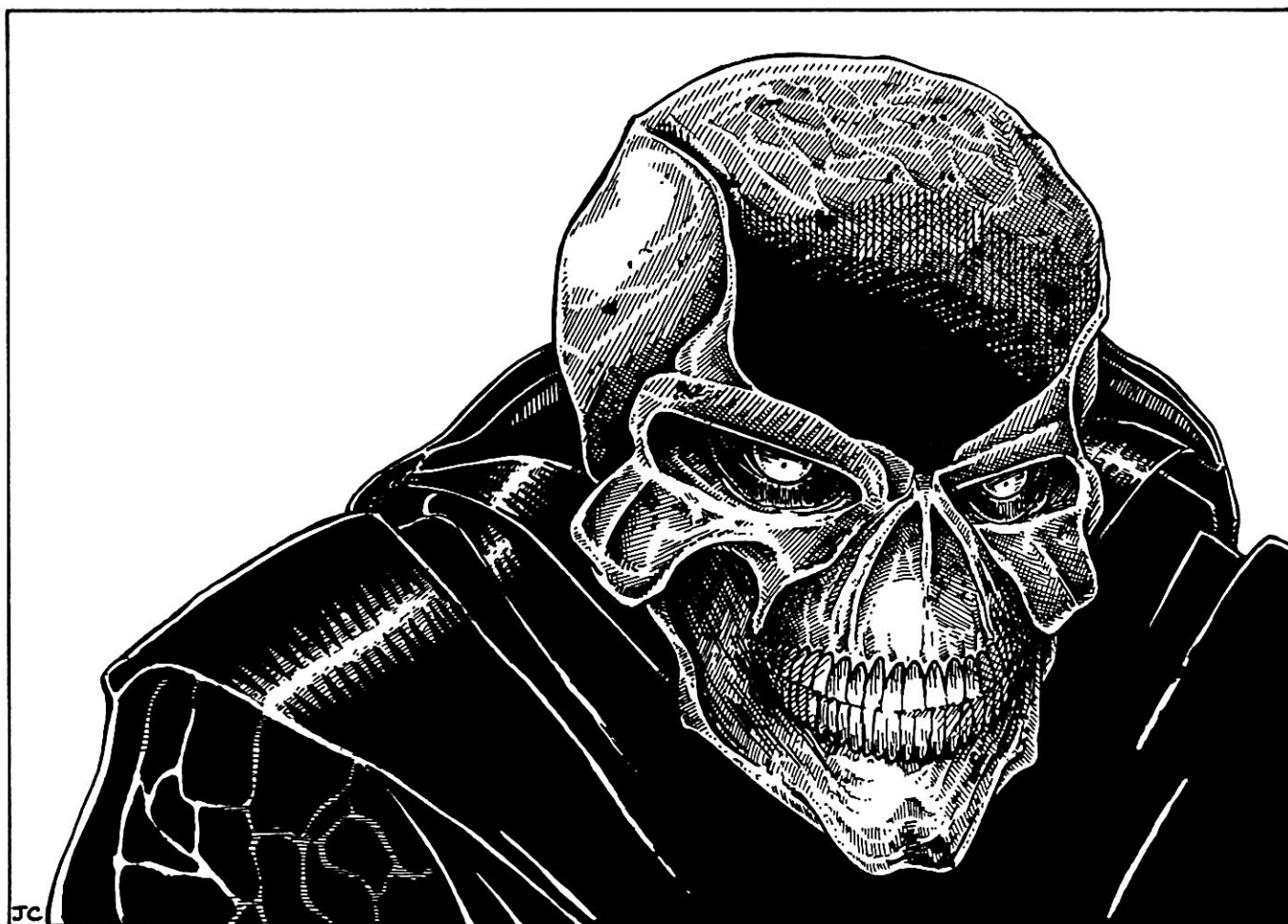

# GENERAL COMBAT REFERENCE TABLES

## IMPORTANT FORMULAS

1. Discharge Combat: (weapon attack number + (skill level x 4) + Man. Dex attack bonus + bracing - cover - movement - sighting - snap shot penalty - called shot penalty - auto fire penalty = Adjusted Attack Number)
2. HTH Combat: (weapon attack number + (skill level x 4) + Agility bonus + Size modifier - Defensive Modifier - movement = Adjusted Attack Number)
3. Initiative: (d10 + encumbrance penalty + weapon penalty - initiative modifier - circumstance modifier = Initiative)
4. Parrying Modifier: The Unadjusted Attack Number is reduced by the defender's total parry negation modifier which equals: weapon parry number + (skill level x 4) + agility bonus

## OCCUPATIONAL SKILLS

1. Maximum of 3 levels of any starting skill above any levels that the race begins the game with. (Human: 5 max.)
2. 25 points to obtain occupational proficiency.
3. 15 points to obtain secondary proficiency.
4. 40 points to obtain expertise in a field (minus 1 point cost)
5. 100 points to obtain mastery in a field (minus 2 point cost)

## ARMOR

1. Armor Integrity equals the total amount of penetrating weapons hits that the armor can take before it is rendered useless.
2. Damage penetration = (Amount of damage done minus threshold)
3. Absorption equals the armor's hit points
4. Heavy armor (threshold: 7+) is not affected by archaic powder hits and lasers only do half damage.

## HAND WEAPONS

1. 1 second per 50 meters of range to aim weapons without scopes.
2. 3 seconds per 50 meters of range to aim weapons with scopes.
3. Fire segment equals 1 second.
4. It takes 1-4 seconds to draw a non-heavy weapon. Pulse cannons, Omega Cannons and disintegrators require 3-12 seconds to draw.
5. Initiative (d10 - Initiative mod for agility).
6. Archaic powder weapons incur a -40 penalty for automatic fire
7. Lasers suffer no penalty for auto fire because there's no kick.
8. Pulse cannons suffer a -50 penalty on automatic.
9. Omega cannons suffer a -60 penalty on automatic.
10. Snap shots incur -40 penalty to hit.
11. No snap shot penalty within 2 meters.
12. Suppression fire generates a -10 to -60 to hit.
13. Suppression fire against enemies -40 penalty.
14. Changing targets requires one second.
15. Reloading takes 3-12 seconds for clips and 5-20 for backpacks.

## GRENADES

1. Normal grenades can be thrown 1/2 strength in meters.
2. Plasma grenades can be thrown 1/3 strength in meters.
3. Super plasma grenades can be thrown 1/4 strength in meters.
4. Plasma seduction can be thrown 1/6 strength in meters.
5. Omegaton grenades can be thrown 1/4 strength in meters.

## SPECIAL POWERS

1. Begin with 2-5 1st level powers and 1 second level power.
2. Chance to find Mentor: (70% + 05% level of controller - 20% per level of energy bracket).
3. Experience points are divided half when determining advancement.
4. Latent extraction costs 15 points to become a Healer, 25 to become an empath, and 35 to become an Energy Controller.

## OUTDOOR SCENARIO PLANNING

1. Layout map of engagement area. Setup terrain.
2. Pre-determine the range that NPCs will begin firing.
3. Divide range by the speed of characters to determine the time necessary to cross distance. The result is the minimum time that NPCs get to engage the party before PCs are in Hand to Hand combat range.
4. Determine penalty modifier to hit, as a result of cover and concealment, etc for both parties based on terrain.
5. Plan a reasonable course of action for the NPCs retreat, advance, hold position, etc.
6. Predetermine time to move from position to position, in the event that NPCs move.
7. Set up traps in according to the NPC doctrine of holding their position, or retreating.
8. Setup tank, and mortar crews if necessary. Provide them with a preplanned general course of action.

## OUTDOOR COMBAT MANAGEMENT

- A. When the party begins advancing, keep track of the amount of time that has gone by. This tells you how long they take to close.
- B. Breaks in the action occur when NPCs or PCs try to change their position in order to obtain superior firepower.
- C. When PCs use suppression fire to provide cover for advancing party members, ask them for how long they are firing in seconds and with what rate of fire. Make sure PCs subtract ammunition.
- D. Critically wounded PCs can not be moved, while the BRI is being administered and are vulnerable.
- E. Remind PCs that while they are dodging around and running crouched, their chance of hitting anything drops significantly.
- F. Make sure that those PCs using scopes, (all lasers and modified archaic powder weapons) take 3 times longer to aim than is normally necessary.

## HAND TO HAND COMBAT

- A. Determine initiative based on initiative modifier, weapon modifier, and circumstance.
- B. PCs and NPCs secretly decide whether they are attacking parrying, playing the bagpipes or whatever.
- C. Determine results. If you are attacking when you should have been parrying, then you are in a world of trouble.
- D. If persons are entitled to multiple attacks per round, divide the number of attacks by 3. This represents how many attacks are made per second.
- E. If PCs switch weapons, be sure to remind them that it takes time.
- F. Matrices take seconds if not minutes to generate. Make sure you take this into account when Fredd goes up against Henry the Mutzachan. Fredd will attack within tenths of a second, while Henry must wait a minimum of 1 second plus his initiative roll.
- G. If weapons discharge is occurring at the same time as Hand to Hand combat, then follow the following procedure: Divide the number of Hand to Hand attacks by 3. This equals their rate of fire per second. Then compare it to the rate of fire for the discharge weapon. Remember that the discharge ROF equals shots per second for full auto, or 3 shots per 3 seconds for normal fire.

# QUICK COMBAT REFERENCE TABLE

- 01 Left foot shattered (-35 agility).
- 02-03 Left calf, clean (-15 agility)
- 04-05 Left shin bone shattered (-45 agility)
- 06 Left knee shattered (-60 agility, -10 permanent)
- 07 Left calf, artery (-25 agility, Bleeds 2 BP/min)
- 08-10 Left thigh, clean (-25 agility)
- 11-13 Left thigh bone shattered (-60 agility)
- 14-15 Left thigh, artery struck (-25 agility, Bleeds 2 BP/min)
- 16-17 Left hip bone chipped (-30 agility)
- 18 Left hip bone shattered (-60 agility)
- 19 Right foot shattered (-35 agility).
- 20-21 Right calf, clean (-15 agility)
- 22-23 Right shin bone shattered (-45 agility)
- 24 Right knee shattered (-60 agility, -10 permanent)
- 25 Right calf, artery (-25 agility, -2 BP/min)
- 26-28 Right thigh, clean (-25 agility)
- 29-31 Right thigh bone shattered (-60 agility)
- 32-33 Right thigh, artery struck (-25 agility, -2 BP/min)
- 34-35 Right hip bone chipped (-30 agility)
- 36 Right hip bone shattered (-60 agility)
- 37 Groin, clean (-70 agility, -20 system shock, -3 BP/min)
- 38 Groin, removed (-100 agility, -60 system shock, -4 BP/min)
- 39-44 Lower abdomen, clean (-35 agility, -10 system shock)
- 45-46 Stomach ruptured (-35 agility, -25 system shock, SMR vs poisoning or die in 2-8 minutes, -3 BP/min).
- 47 Stomach ruptured (-35 agility, -25 system shock, SMR vs poisoning or die in 1-4 minutes.)
- 48-49 Liver (-4BP/min)
- 50-51 Liver. You are spilling blood everywhere and making quite a puddle (-6 BP/min)
- 52 Intestines (-35 agility, SMR vs poisoning, -4 BP/min)
- 53 Multiple organs (-80 agility, -80 system shock, die in 1-4 min)
- 54 Lower spine. Forget walking or doing the "Wild Thing." (-120 Agility, -50 system shock, 50% paralysis)
- 55-59 Lung punctured (-50 agility, -65 system shock, 4 BP/min). Asphyxiation from drowning in blood in 1-4 minutes.
- 60-61 Struck spinal cord, (-120 agility, -50 SS, 50% chance of paralysis)
- 62 Spinal cord is now in two distinct sections. (instant death)
- 63 Heart (unconscious, -10 BP/min)
- 64 Blows heart apart (instant death)
- 65 Multiple organs struck. Internals reduce to a jelly-like mixture. (instant death)
- 66-68 Ribs (-40 agility). You got lucky!
- 69-71 Ribs shattered (-50 agility, -30 system shock). Move and the chips have a 50% chance of puncturing a lung or two.
- 72 Collar bone broken (-30 agility)
- 73 Left hand shattered (-10 agility, -60 man dex, -10 permanently)
- 74-76 Left arm (-10 agility, -40 manual dexterity)
- 77-78 Left arm, messy (-30 agility, -45 manual dexterity, -2 BP/min)
- 79 Left elbow shatters (-20 agility, -60 man dex, -20 permanently)
- 80 Left shoulder, clean (-30 agility, -40 manual dexterity)
- 81 Left shoulder broken (-40 agility, -60 manual dexterity)
- 82 Right hand shattered (-10 agility, -60 man dex, -10 permanently)
- 83-85 Right arm (-10 agility, -40 manual dexterity)
- 86-87 Right arm, messy (-30 agility, -45 manual dexterity, -2 BP/min)
- 88 Right elbow shattered(-20 agility, -60 man dex, -20 permanently)
- 89 Right shoulder, clean (-30 agility, -40 manual dexterity)
- 90 Right shoulder broken (-40 agility, -60 manual dexterity)
- 91 Larynx (-25 agility, -30 system shock, can't speak for 2 weeks)
- 92 Neck (-25 agility, -60 system shock, -3 BP/min)
- 93 Mouth (-1 BP per min, -10 charisma permanent)
- 94 Face partially removed (unconscious, -3 BP/min, -20 charisma permanently)
- 95 Jaw shattered (-20 agility, -40 system shock, -3 BP/min)
- 96 Enters eyes and exits back of skull. (instant death)
- 97 Forehead (unconscious, -5 BP/min, -10 points of I.Q. and Intuition permanently).
- 98 Temple (concussion, -80 system shock, disoriented 2 days)
- 99 Top of head blown off (You're history pal!). There is all kinds of neat stuff oozing everywhere.
- 100 Head removed from the shoulders and you don't walk around like a chicken with its head cut off. (roll up new character)

## WEAPON RANGE BRACKETS

Hand Weapons	Anti-Tank	Vehicle
1). 01-05	1). 01-50	1). 01-75
2). 06-15	2). 51-100	2). 76-200
3). 16-25	3). 101-250	3). 201-500
4). 26-50	4). 251-500	4). 501-1000
5). 51-150	5). 501-1000	Beyond: 5000
6). 151-300	6). 1001-1500	
7). 301-700	7). 1501-3000	Space: x100 km
8). 700-2000	8). 3001+	

## Grenade Throwing Table

Range Bracket	1	2	3	4	5	6	7	8
Distance	05	10	15	20	25	30	35	40
Attack %	80	70	50	30	20	10	00	-10

## SIGHTING CHECKS MOVEMENT

RANGE	BASE	Movement	DM	OM
01-05	300%	Crawl	-20	N/A
06-15	250%	Crouched Run	-15	-15
16-25	150%	High Crawl	-25	N/A
26-50	75%	Low Crawl	-35	N/A
51-150	25%	Dive	-15	N/A
151-300	10%	Roll	-20	-70
301-700	05%	Evasion	+15	N/A
701-2000	01%			

## COMBAT MODS

CIRCUMSTANCE	MOD	CIRCUMSTANCE	MOD
Stationary Target	+10	Smoke	-30
Prostrate Target	+30	Darkness	-20
Speed 01-10	+00	Silhouetted in Dark	-10
11-20	-10	Size Class 1	-20
21-30	-20	Size Class 2	-10
31-40	-30	Size Class 3	-05
41-50	-40	Size Class 4	00
51-100	-50	Size Class 5	+05
101-200	-60	Size Class 6	+10
201-500	-70	Size Class 7	+15
501-1000	-80	Size Class 8	+20
1001-2000	-90	Moderate Wind	-10
2001-5000	-100	Severe Wind	-30
Aimed Shot	+07	Hurricane Force	-90
Braced Shot	+10	Attacking with two weapons:	
Snap Shot	-40	First	-10
Suppressive Fire	-20	Secondary	-25
Cover 25%	-10	Range stakes	+05
Cover 50%	-25		
Cover 75%	-40		
Cover 90%	-50		
Concealment 25%	-08		
Concealment 50%	-17		
Concealment 75%	-25		
Concealment 90%	-30		
Called Shots:			
Head	-50		
Arm	-50		
Leg	-20		
Chest	-15		
Abdomen	-20		
Hand	-60		
Foot	-60		
Throat	-75		
Eye	-90		

# BATTLELORDS of the 23<sup>rd</sup> CENTURY

## CHARACTER RECORD SHEET

<b>Vital Statistics</b>	STRENGTH	ENCUMBRANCE	DAMAGE	SKILL	NAME				RACE
	MAN DEXTERITY	ATTACK	SKILL		HEIGHT	WEIGHT	SIZE CLASS	BODY POINTS	
	INTELLIGENCE	PWR PTS	LANGUAGES	SKILL	MOVEMENT (s/m/d)	# of ATTACKS	DAMAGE		
	AGILITY	INITIATIVE	DEFENSE	SKILL	VISION MODIFIER	SMELL MODIFIER	HEARING MODIFIER		
	CONSTITUTION	SYS SHOCK	RESURRECT	DEATHSDOOR	BODY	SMR	PLANET OF ORIGIN		
	AGGRESSION	BERSERK	SUICIDE		HONOR		ALIGNMENT		
	INTUITION	MENTAL	PERCEPTION		SOCIAL CLASS	OCCUPATION (primary)	TOTAL EXPERIENCE		
	CHARISMA	REACTION	LOYALTY		SPONSOR		EXPERIENCE AVAILABLE		
	terrestrial knowledge	military leadership	persuasion	bargaining		SALARY	RANK	HAIR COLOR	EYE COLOR
	CASH ON HAND	BANK BALANCE		LOANS		AWARDS		SEX	AGE
	CARD BALANCE	CARD LIMIT	CREDIT RATING		BLACK MARKS		LANGUAGES		
BILLS DUE	VALUABLES		NET WORTH						

<b>Armor</b>	INTEGRITY	helmet	ABSORPTION	helmet	HELMET	TYPE	AI	THRESHOLD	AR	ENCUMBRANCE		
	left arm	chest	right arm	left arm	chest	right arm	ARMOR	TYPE	AI	THRESHOLD	AR	ENCUMBRANCE
	abdomen		abdomen		ARMOR OPTIONS		WEAPONS		AMMUNITION		GRENADES, etc.	
	left leg	right leg	left leg	right leg								

<b>Weapons</b>	WEAPON	RANGE MODIFIERS								BONUS	MF	SS	ROF	Q	DAM
		1	2	3	4	5	6	7	8						

<b>Combat</b>	CURRENT BODY POINTS	INITIATIVE	DEFENSIVE	BODY THRESHOLD	FAVORITE WEAPON	FAVORITE GRENADE
	WOUNDS	BIONICS		SPECIAL ABILITIES	OTHER / NOTES	

**Personal Information**

**Armor**

**Weapons**

**Combat**



# C H A R A C T E R R E C O R D S H E E T

-page 2-

Skills	PRIMARY OCCUPATION			SECONDARY OCCUPATION			OTHER SKILLS			OTHER SKILLS		
	SKILL	LEVEL	MOD	SKILL	LEVEL	MOD	SKILL	LEVEL	MOD	SKILL	LEVEL	MOD

Matrix Control	POWER POINTS		POWER TYPE		LEVEL		ROBE / CRYSTAL		TITLE	
	POWER	POINTS	POWER	POINTS	POWER	POINTS	POWER	POINTS	POWER	POINTS

Personal Portfolio	CONFIRMED KILLS	MISSIONS	W.I.A.	SCARS	CHEMICAL	RADIATION	BIOLOGICAL	MENTAL	POISON
	PERSONAL DESCRIPTION					SONIC	ELECTRIC	FIRE	ACID
PERSONAL VIEWS									
CORPORATE STANDING									
PLANETS VISITED									
FRIENDS AND ENEMIES									
WHEN I WAS GROWING UP..									

Skills

Matrix Control

SMRs

Equipment List & Notes

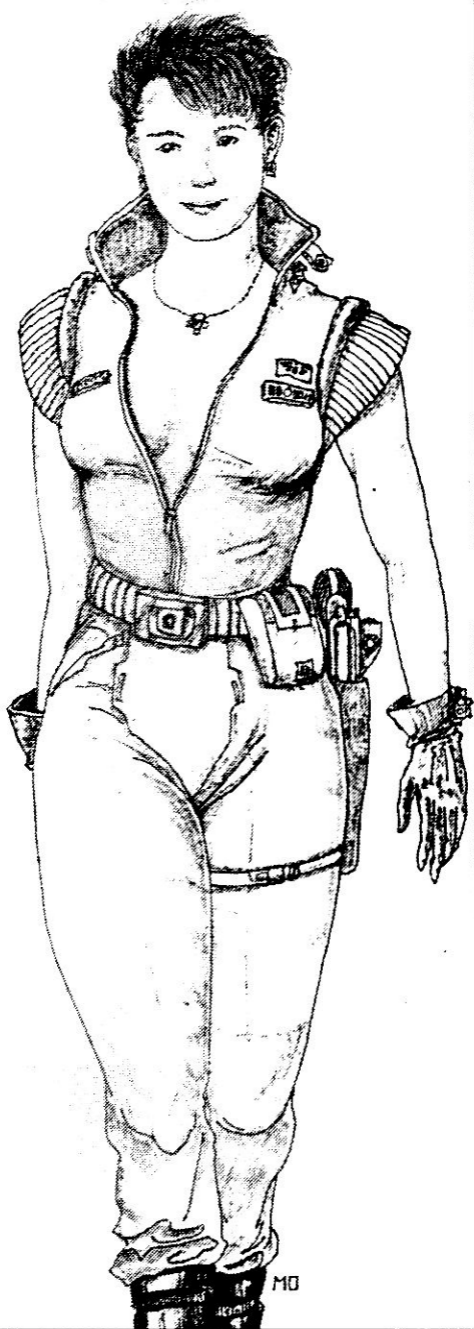

The year is 2279. Exploration of the universe is carrying on at a fantastic rate. Huge mega-corporations run it all behind the scenes. The Twelve Races of the Forge work as caretakers, shaping the horizons of knowledge across the deepest reaches of space. Reports of ghost ships, robot warriors, and evidence of ancient human cultures, filter their way across the vast emptiness to the ears of the bold, strong, and curious.

Battlelords of the 23rd Century is a futuristic roleplaying game designed to simulate the adventures of explorer and combat types in the not too distant future.

